



be water, be Genebre

2014

HYDROSANITARY LINE



LÍNEA HIDROSANITARIA



Be water, be Genebre

EL AGUA ES LA ESENCIA DE LA VIDA

El agua es un bien fundamental para la vida y el planeta, pero también un recurso escaso y limitado cuyo consumo va en aumento. Estamos acostumbrados a verla correr y, hasta hace poco, se creía inagotable. Sin embargo, hoy sabemos que la mayor parte del agua de la Tierra es salada o se encuentra en forma de casquetes polares o glaciares, y solo una pequeña parte es útil para los procesos vitales del planeta. De modo que para su conservación en el futuro se necesita una actitud responsable diaria y una mayor conciencia ambiental de cada uno de nosotros. Podemos soñar con un futuro más sostenible, pero para que este sueño se haga realidad debemos empezar desde el presente. Desde hoy.

WATER IS THE ESSENCE OF LIFE

Water is an essential resource for life and for the planet. At the same time, water is also scarce and limited. In our minds, water is always running, and until recently, it was thought to be in endless supply. However, its usage is increasing. Today we know that most of the water on Earth is salt water, or is found in the form of glaciers or ice caps, and only a small part is usable for the planet's vital processes. Therefore, to conserve water for the future, each and every one of us needs to have a responsible attitude towards it, as well as greater environmental awareness. We can dream about a more sustainable future, but in order to make this dream a reality, we have to start now. Starting today.



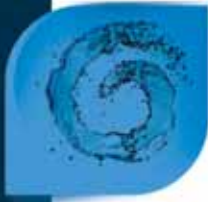

LA CALIDAD ES NUESTRA
MÁXIMA PRIORIDAD

QUALITY, OUR HIGHEST
PRIORITY



CE 0035



Test de calidad del agua
para valvulería y grifería
*Water quality test for valves
and taps*



Nº AT/2002-02-1182
Homologación TIN Polonia



POCC ES A1077 B01804
Homologación Ghost Rusia



GENEBRE

NUESTRA CALIDAD Y UNA FILOSOFÍA CENTRADA EN LA INNOVACIÓN NOS HAN ABIERTO LAS PUERTAS EN TODO EL MUNDO

Genebre es una empresa familiar fundada en 1981 líder en válvulas para el control de fluidos y grifería de alta calidad. Controla todos los procesos de creación para dar respuesta a las necesidades de los clientes en cada mercado, desde el concepto y el diseño del producto, a la producción y la comercialización.

La sede central está situada en Barcelona. Cuenta con una plantilla de 185 profesionales, un catálogo de más de 15.000 artículos y una red de agentes comerciales distribuidos por toda España, además de Europa y Sudamérica, entre otros.

La gran expansión internacional de la compañía, que actualmente ya representa el 70% de la facturación del Grupo, la ha consolidado como un referente mundial dentro del sector del control de fluidos. Una filosofía de crecimiento que hoy en día se confirma con más de cincuenta centros productivos en los que intervienen más de 10.000 personas; filiales en Argentina, Brasil, México, Uruguay y China, y una exportación que alcanza los 110 países.

Asimismo, firme en su voluntad de garantizar la calidad y las buenas prácticas en todos los procesos de producción y organización, Genebre trabaja aplicando las normas más estrictas:

- **Modelo Europeo de Excelencia Empresarial (EFQM)**. de la European Foundation for Quality Management
- **ISO 9001**. Sistema de Gestión de Calidad.
- **ISO 14001**. Sistema de Gestión Ambiental (SGA).
- **UNE 166.002:2006**. Sistema de Gestión del I+D+i.
- **Homologación CE**. Los productos Genebre están homologados CE y otras específicas para ciertos mercados como Bielorrusia, Chile, Polonia, Rusia, Ucrania.

OUR QUALITY AND INNOVATION-CENTERED PHILOSOPHY HAVE OPENED DOORS FOR US WORLDWIDE

Genebre is a family company founded in 1981, and is a leader in valves for fluid control and high quality taps. The company controls all the creation processes to respond to the needs of the clients in each market, from the concept and design of the product, to the production and the commercialization.

The central headquarters are located in Barcelona with a highly qualified team of 185 professionals, a catalogue of more than 15,000 products, and a network of commercial agents distributed throughout Spain, in addition to Europe and South America, among others.

The company's important international expansion, which currently represents approximately 70% of the Group's turnover, has established it as a world reference in the fluid control sector. Genebre has a growth philosophy which is currently confirmed with more than fifty production plants, and more than 10,000 people involved in these processes. It has subsidiaries in Argentina, Brazil, Mexico, Uruguay and China, and its exports, which are in continual expansion, reach 110 countries.

Genebre carries out its activities applying the strictest regulations, at the same time with a solid desire to guarantee quality and good practices in all of the production and organizational processes:

- **The European Business Excellence Model (EFQM)** from The European Foundation for Quality Management
- **ISO 9001**. Quality Control System
- **ISO 14001**. Environmental Management System (SGA)
- **UNE 166.002:2006**. R+D+i Management System
- **EC Certification**. Genebre products are EC certified and other specific certifications for markets such as Belorussia, Chile, Poland, Russia, and Ukraine.



CONTACTE CON NOSOTROS CONTACT US

ESPAÑA / SPAIN

e-mail: hidrosanitaria@genebre.es

web: www.genebre.es
Tel: 93 298 80 01
Fax: 93 298 80 06

INTERNACIONAL / INTERNATIONAL

e-mail: exportacion@genebre.es

web: www.genebre.com
Tel: Europa: +34 93 298 80 15
Europa este: +34 93 298 80 19
América Latina: +34 93 298 80 17
North América: +34 93 298 80 17
Fax: +34 93 298 80 08

HORARIO COMERCIAL/
COMMERCIAL TIMETABLE:

8.30 h. - 13.30 h. / 15.00 h. - 18.00 h.

CORREO / MAILING ADDRESS

Edificio Genebre
Av. Joan Carles I, 46-48
Distrito económico de L'Hospitalet
L'Hospitalet de Llobregat
08908 Barcelona (Spain)

OTROS TELÉFONOS/
OTHER GENERAL TELEPHONE NUMBERS

Tel. Centralita / Central Telephone number:
+34 93 298 80 00

Administración / Administration:
+34 93 298 80 02
Fax: +34 93 298 80 07

Servicio de Atención Técnica al Cliente /
Technical Support Telephone number:
+34 902 504 203



GENEBRE



PROMOVRIENDO LA SENSIBILIDAD Y EL RESPETO POR EL MEDIOAMBIENTE

Genebre es una compañía comprometida con el medioambiente. Su visión de un futuro sostenible y una filosofía enfocada a proteger el agua y los fluidos le permiten mejorar, investigar, desarrollar y crear conceptos innovadores a partir de las tecnologías más punteras. De manera que aplica siempre criterios que transmitan valores ecológicos en todos sus productos y a la vez que satisfagan las necesidades de funcionalidad, confort y diseño de los usuarios.

Actualmente, **Genebre** está colaborando en el programa de I+D NUESVAL. Un estudio coordinado por el Centro Tecnológico de Manresa cuyo objetivo es desarrollar nuevas aleaciones de latón para válvulas de conducción de fluidos en condiciones ambientales de alta temperatura. Un modelo de proyecto basado en la innovación, en el que **Genebre** ha depositado su compromiso empresarial, con el fin de desarrollar tipos específicos de válvulas destinadas tanto a instalaciones domésticas como industriales.

PROMOTING RESPECT FOR THE ENVIRONMENT

***Genebre** is a company committed to the environment. Its vision of a sustainable future and a philosophy focused on protecting water and fluids allow it to improve, research, develop and create innovative concepts using the most advanced technologies. Genebre always applies the same criteria which transmits ecological values in all of its products, and at the same time satisfies the users' needs of functionality, comfort, and design.*

*Currently, **Genebre** is collaborating in the NUESVAL R+D program, a study coordinated by the Centro Tecnológico de Manresa, whose objective is to develop new brass and bronze alloy for valves. It is a project model based on innovation, in which Genebre reinforces its commitment to developing specific types of valves for domestic as well as industrial installations.*



VÁLVULAS VALVES

Pág. 13-61

Válvulas de esfera / <i>Ball valves</i>	Pág. 15-21
Válvulas esfera Mini / <i>Mini ball valves</i>	Pág. 19-20
Válvulas de empotrar / <i>Built-in valves</i>	Pág. 22-23
Válvulas para manguera / <i>Bibcock valves</i>	Pág. 25-27
Válvulas para barril / <i>Barrel valves</i>	Pág. 29
Válvulas escuadra / <i>Angle valves</i>	Pág. 30-32
Válvulas de retención / <i>Check valves</i>	Pág. 33-36
Válvulas de compuerta / <i>Check valves</i>	Pág. 38-39
Filtros / <i>Filtres</i>	Pág. 39, 42
Válvulas reductoras de presión / <i>Pressure reducer valves</i>	Pág. 42, 44
Colectores / <i>Collectors</i>	Pág. 45
Presostatos / <i>Pressure Switch</i>	Pág. 46
Controladores / <i>Controllers</i>	Pág. 48-50
Manómetros / <i>Pressure gauges</i>	Pág. 51-54
Servicios de Agua / <i>Waterworks</i>	Pág. 56-61



ELECTROVÁLVULAS SOLENOID VALVES

Pág. 95-110

Electroválvulas 2/3 vías / <i>2/3 ways solenoid valves</i>	Pág. 97-105
Electroválvulas para gas / <i>Gas solenoid valves</i>	Pág. 105-106
Válvulas hidráulicas / <i>Hydraulic valves</i>	Pág. 107
Bobinas y conectores / <i>Coils and connectors</i>	Pág. 108-109



CLIMATIZACIÓN
CLIMATE CONTROL

Válvulas escuadra / <i>Angle Valves</i>	Pág. 65-70
Cabezales térmicos / <i>Thermal heads</i>	Pág. 71
Monotubo / <i>Single-pipe</i>	Pág. 71
Válvulas de seguridad / <i>Safety valves</i>	Pág. 72
Purgadores / <i>Air vent</i>	Pág. 73
Colectores / <i>Manifolds</i>	Pág. 74-75
Válvulas motorizadas / <i>Motorised valves</i>	Pág. 76-77
Termostatos / <i>Thermostates</i>	Pág. 77-79
Bombas de condensación / <i>Condensate pumps</i>	Pág. 79
Energía solar / <i>Energy solar</i>	Pág. 80-86



VÁLVULAS DE GAS
GAS VALVES

Válvulas rectas / <i>Straight valves</i>	Pág. 89-90
Válvulas escuadra / <i>Square valves</i>	Pág. 90
Válvulas rectas cromadas / <i>Chrome-plated straight valves</i>	Pág. 91-92
Válvulas escuadra cromadas / <i>Chrome-plated angle valves</i>	Pág. 92-93



ACCESORIS DE LATÓN
BRASS ACCESSORIES

Accesorios Rac-ge / <i>Rac-ge Accessories</i>	Pág. 112-117
Otros accesorios de latón / <i>Other brass accessories</i>	Pág. 118-124



CONTADORES
WATER METERS

Contadores a rosca / <i>Threaded water meters</i>	Pág. 127-129
Contadores a brida / <i>Flanged water meters</i>	Pág. 129
Contador de calorías / <i>Calories meters</i>	Pág. 130
Accesorios / <i>Accessories</i>	Pág. 130

CONDICIONES GENERALES DE VENTA
GENERAL SALES CONDITIONS

Pág. 131

Nº Artículo Article Num.	Nº Página Page Num.	Nº Artículo Article Num.	Nº Página Page Num.	Nº Artículo Article Num.	Nº Página Page Num.	Nº Artículo Article Num.	Nº Página Page Num.
0010	119	3023	15	3107	32	3253	49
0012	113	3028	15	3108	32	3254	49
0015	119	3029	16	3120	34	3255	79
0017	113	3030	16	3121	33	3256	79
0020	119	3032	16	3121N	33	3264	50
0022	114	3033	17	3122	33	3265	50
0025	120	3034	17	3122N	33	3272	18
0030	120	3035	17	3123	34	3282	18
0032	114	3036	17	3131	34	3294	30
0035	120	3037	17	3134	81	3296	19
0037	115	3038	17	3136	81	3297	20
0040	121	3044	20	3140	35	3302	39
0042	115	3046	18	3141	33	3302N	39
0045	121	3048	18	3144	82	3304	40
0047	116	3051	61	3145	35	3310	40
0048	122	3056	22	3145N	35	3311	40
0049	117	3059	26	3160	35	3312	40
0050	122	3059R	26	3160N	35	3313	41
0052	116	3060	26	3178	81	3314	41
0055	117	3060F	26	3179	72	3315	41
0055	122	3061	25	3180	36	3316	42
0056	123	3062	25	3180N	36	3318	42
0057	123	3062R	25	3181	22	3320	43
0058	123	3063	27	3182	72	3322	42
0061	117	3064	27	3183	23	3324	43
0062	117	3065	28	3184	23	3340	43
0063	117	3066	27	3185	36	3344	44
0500	84	3066B	27	3185N	36	3396	20
0505	84	3068	29	3187	36	3397	20
0525	84	3069	39	3188	72	3430	57
0550	85	3070	19	3189	72	3430N	57
0560	85	3073	75	3190	36	3434	57
0565	85	3075	18	3190N	36	3438	57
0570	85	3080	19	3191	72	3442	57
0575	86	3081	21	3192	72	3446	58
0580	86	3082	21	3193	37	3450	58
0585	84	3083	22	3194	37	3454	58
1431S	82	3084	60	3195N	31	3462	58
1431U	82	3085	61	3211	28	3466	59
1444	83	3088	61	3215	29	3478	59
1451	83	3089	61	3217	28	3482	59
1452	83	3090	32	3220	38	3485	59
2444	82	3091	32	3221	38	3486	59
2848	48	3092	32	3221N	38	3490	60
2850	48	3094	30	3222	38	3491	60
2918	29	3094E	30	3228	38	3499	60
2919	29	3095	31	3230	39	3500	91
3017N	16	3095N	31	3234	21	3505	91
3020	15	3096	19	3235	22	3510	91
3020N	15	3097	19	3236	39	3515	91
3021	15	3104	30	3250	49	3520	91
3022	16	3106	31	3251	49	3525	92

Nº Artículo Article Num.	Nº Página Page Num.	Nº Artículo Article Num.	Nº Página Page Num.	Nº Artículo Article Num.	Nº Página Page Num.	Nº Artículo Article Num.	Nº Página Page Num.
3550	92	3900	78	4632	105	70038	73
3555	92	3901	78	4710	107	70041	71
3560	92	3902	78	4711	107	70048	70
3565	92	3905	79	4720	107	70049	70
3570	93	3906	79	4721	107	70070	71
3575	93	3907	72	4722	107	70071	71
3583	93	3910	44	4723	107	70080	75
3600	90	3910I	44	4730	107	70081	75
3610	89	3911	77	4731	107	70082	75
3615	89	3912	77	4790	76	70083	76
3620	89	3913	78	4791	76	70084	76
3622	89	3914	78	4792	77	70090	76
3625	89	3950	55	4793	77	70151	65
3627	90	3952	55	4801	109	70151	67
3630	90	3955	55	4803	109	70152	65
3632	90	3956	55	4804	109	70152	67
3650	90	4010	97	4805	108	70153	65
3714	53	4020	97	4808	108	70153	67
3772	44	4021	98	4814	108	70153	69
3773	44	4022	97	4819	109	70154	65
3775	45	4030	98	4828	108	70154	67
3777	45	4031	98	4858	108	70154	69
3778	45	4040	99	6010	127	70175	75
3780	46	4041	99	6011	127	70176	75
3781	46	4050	99	6015	127	70300	93
3784	46	4082	104	6020	127	70306	71
3785	46	4100	103	6021	127	70500	79
3788	45	4110	105	6029	128	70564	66
3814	53	4112	105	6029P	128	70564	68
3818	51	4115	106	6038	130	70564	70
3819	51	4118	106	6040	130	70565	66
3820	51	4120	106	6041	130	70565	68
3820N	51	4122	106	6045	130	70565	70
3821	52	4210	99	6060	129	70587	66
3822	52	4220	100	6060A	129	70587	68
3822N	53	4232	100	6066	130	70588	66
3824	54	4240	100	6085	130	70588	68
3824N	54	4250	101	6090	128	70590	71
3825	52	4320	101	6110C	127	71012	73
3826	52	4322	101	6111C	128	71028	71
3827	54	4324	101	6120C	127	K3000	21
3829	53	4328	101	6121C	128	K3052	25
3850	38	4330	102	6192	129	K4000	109
3860	37	4332	102	70017	73	M3054	24
3865	37	4335	102	70018	73	M3055	24
3880	47	4336	102	70031	69	M3057	24
3881	47	4340	102	70032	69	MKalo	23
3882	47	4425	103	70035	74	Mkross	24
3883	47	4426	103	70036	74	P3052	23
3884	50	4440	103	70037	73	P4519	104
3886	48	4519	104	70037	74	R360	28
3887	48	4630	104	70037	81		



VÁLVULAS / VALVES

Una gama completa de válvulas de latón, esfera manguera, retención, compuerta, filtros, manómetros, etc para todo tipo de instalaciones.

A complete range of ball brass valves, bibcock ball valves, retention valves, gate valves, strainers, pressure gauges, etc for all types of installations.





Ref. 3020 - 3020N



Válvula de esfera serie pesada

También disponible con rosca NPT (3020N)
PN 40. Paso total. Construcción en latón UNE-EN 12165 cromado.
Asientos PTFE. Extremos rosca gas (BSP) H-H - ISO 228/1.
Temp. máx. 180°C. Mando manual por palanca de acero.

Heavy ball valve

Also available NPT thread (3020N)
PN 40. Full bore. Body chrome plated brass UNE-EN 12165.
PTFE seats. Gas threaded ends (BSP) F-F - ISO 228/1.
Max. Temp. 180°C. Steel lever manual control.

R	P	A	L	M
1/4"	10	45	48	84
3/8"	10	45	50	84
1/2"	15	47	58	84
3/4"	20	58	65	98
1"	25	61	78	98
1 1/4"	32	74	88	126
1 1/2"	40	80	105	126
2"	50	91	122	158

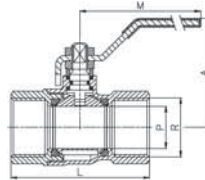

CÓDIGO CODE	MEDIDA SIZE	PESO WEIGHT	CAJA / BOX CARTON	P.V.P. € PRICE €
3020 02	1/4"	135	8-192	4,25
3020 03	3/8"	135	8-192	4,25
3020 04	1/2"	180	8-144	5,10
3020 05	3/4"	285	8-96	7,47
3020 06	1"	450	6-72	11,89
3020 07	1 1/4"	715	4-48	18,28
3020 08	1 1/2"	1075	2-24	25,40
3020 09	2"	1645	2-18	39,48

Precios rosca NPT a consultar / NPT thread prices on request

Ref. 3021



Válvula de esfera serie pesada

PN 40. Paso total. Construcción en latón UNE-EN 12165 cromado.
Asientos PTFE. Extremos rosca gas (BSP) H-H - ISO 228/1.
Temp. máx. 180°C. Mando manual por palanca de acero inox.

Heavy ball valve

PN 40. Full bore. Body chrome plated brass UNE-EN 12165. PTFE seats. Gas threaded ends (BSP) F-F - ISO 228/1.
Max. Temp. 180°C. Stainless steel lever manual control.

R	P	A	L	M
1/4"	10	45	48	84
3/8"	10	45	50	84
1/2"	15	47	58	84
3/4"	20	58	65	98
1"	25	61	78	98
1 1/4"	32	74	88	126
1 1/2"	40	80	105	126
2"	50	91	122	158

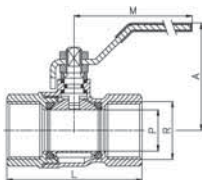

3021 02	1/4"	135	8-192	5,10
3021 03	3/8"	135	8-192	5,10
3021 04	1/2"	185	8-144	5,94
3021 05	3/4"	305	8-96	8,98
3021 06	1"	450	6-72	13,23
3021 07	1 1/4"	715	4-48	21,32
3021 08	1 1/2"	1075	2-24	28,87
3021 09	2"	1645	2-18	44,40

Ref. 3023



Válvula de esfera para montaje actuador

PN 40. Paso total. Construcción en latón UNE-EN 12165 cromado.
Asientos PTFE + grafito. Extremos rosca gas (BSP) H-H - ISO 228/1.
Temp. máx. 180°C. Tóricas vitón. Conexión a actuador ISO 5211 y DIN 3337. Palanca en acero galvanizado con recubrimiento de vinilo.

Ball valve for direct mount

PN 40. Full bore. Body chrome plated brass UNE-EN 12165.
PTFE + graphite seats. Gas threaded ends (BSP) F-F - ISO 228/1.
Max. Temp. 180°C. Viton o-rings. Actuator connection ISO 5211 and DIN 3337. Galvanized steel lever with vinyl cover.

R	P	A	M	L	X	H	E	Q	ISO5211
1/2"	15	57	100	65	18	32	8,5	9	F03
3/4"	20	60	115	75	20	36,5	8,5	9	F03
1"	25	64	115	86	22	39,5	8,5	9	F04
1 1/4"	32	74	122	100	25	47	10	11	F05
1 1/2"	40	80	122	115	27	52,5	10	11	F05
2"	50	90	144	132	29	63,5	10	11	F05 F07

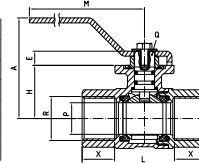

3023 04	1/2"	285	-	12,64
3023 05	3/4"	430	-	17,68
3023 06	1"	620	-	26,20
3023 07	1 1/4"	1045	-	48,69
3023 08	1 1/2"	1425	-	57,17
3023 09	2"	2375	-	92,96

Ref. 3028



Válvula esfera serie ligera

PN 25. Paso estándar. Construcción en latón UNE-EN 12165 cromado. Asientos PTFE. Extremos rosca gas (BSP) H-H - ISO 228/1.
Temp. máx. 180°C. Mando manual por palanca de acero.

Light ball valve

PN 25. Standard bore. Body chrome plated brass UNE-EN 12165.
PTFE seats. Gas threaded ends (BSP) F-F - ISO 228/1.
Max. Temp. 180°C. Steel lever manual control.

R	P	A	L	M
1/2"	14	46	44	84
3/4"	18	50	51	84
1"	23	57	61	92
1 1/4"	27	63	71	98
1 1/2"	34	74	81	113
2"	43	83	93	128
2 1/2"	52	96	118	158
3"	65	126	137	196
4"	79	137	163	265

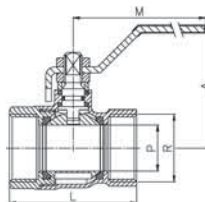

3028 04	1/2"	130	8-192	3,08
3028 05	3/4"	200	8-128	4,42
3028 06	1"	320	8-96	7,33
3028 07	1 1/4"	420	6-72	9,71
3028 08	1 1/2"	655	2-24	16,80
3028 09	2"	975	2-24	23,54
3028 10	2 1/2"	1845	6-12	53,94
3028 11	3"	3035	4-8	85,89
3028 12	4"	4725	2-4	135,94

Ref. 3029 - 3022



Válvula de esfera

También disponible con rosca NPT (3022)
PN 25. Paso total. Construcción en latón UNE-EN 12165 cromado.
Asiento PTFE. Extremos roscados H-H - ISO 228/1. Temp. máx.
180°C. Mando manual por palanca de acero.

Ball valve

Also available NPT thread (3022)
PN 25. Full bore. Body chrome plated brass UNE-EN 12165. PTFE
seats. Treated ends F-F - ISO 228/1. Max. temp.180°C. Steel lever
manual control.

R	P	A	L	M
1/4"	10	46	40	84
3/8"	10	46	43	84
1/2"	15	47	49	84
3/4"	20	58	56	98
1"	25	61	68	98
1 1/4"	32	74	80	126
1 1/2"	40	80	89	126
2"	50	91	104	158
2 1/2"	59	101	137	158
3"	72	131	158	196
4"	90	145	183	265

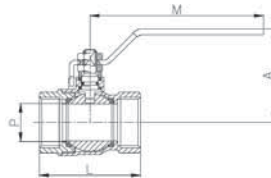

CÓDIGO CODE	MEDIDA SIZE	PESO WEIGHT	CAJA / BOX CARTON	P.V.P. € PRICE €
3029 02	1/4"	105	10-240	2,88
3029 03	3/8"	110	10-240	2,88
3029 04	1/2"	150	8-192	3,56
3029 05	3/4"	250	8-96	5,72
3029 06	1"	380	6-72	8,75
3029 07	1 1/4"	595	4-48	13,70
3029 08	1 1/2"	830	2-24	19,49
3029 09	2"	1330	2-18	31,12
3029 10	2 1/2"	2475	4-8	59,69
3029 11	3"	3925	2-4	96,29
3029 12	4"	6005	1-2	146,84

Precios rosca NPT a consultar / NPT thread prices on request

Ref. 3017N



Válvula de esfera

400 WOG. Paso total. Construcción en latón UNE-EN 12165.
Asientos PTFE. Extremos rosca NPT - H-H. Temperatura máx. 180°C.
Mando manual por palanca de acero

Ball valve

400 WOG. Full bore. Brass construction UNE-EN 12165. PTFE seats.
NPT threaded ends - F-F. Max. temperature 180°C. Steel lever manual
control.

R	P	A	L	M
1/2"	15	47	49	84
3/4"	20	58	56	98
1"	25	61	68	98
1 1/4"	32	74	80	126
1 1/2"	40	80	89	126
2"	50	91	104	158
2 1/2"	59	101	137	158
3"	72	131	158	196
4"	90	145	183	265

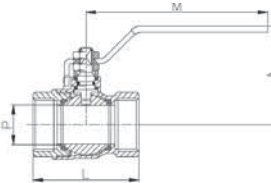

3017N 04	1/2"	160	8-144	3,80
3017N 05	3/4"	270	8-96	6,09
3017N 06	1"	395	6-72	9,28
3017N 07	1 1/4"	620	4-48	14,99
3017N 08	1 1/2"	865	2-24	20,88
3017N 09	2"	1365	2-18	33,56
3017N 10	2 1/2"	2490	4-8	63,88
3017N 11	3"	4125	2-4	103,08
3017N 12	4"	6300	1-2	157,15

Ref. 3032



Válvula de esfera con tomas laterales

PN 25. Paso total. Construcción en latón UNE-EN 12165 cromado.
Asientos PTFE. Extremos rosca gas (BSP) H-H - ISO 228/1. Temp.
máx. 180°C. Mando manual por palanca acero. 2 tomas laterales
1/4" - 1 de ellas con tapón.

Ball valve with side inlets

PN 25. Full bore. Body chrome plated brass UNE-EN 12165. PTFE
seats. Gas threaded ends (BSP) F-F - ISO 228/1. Max. temp. 180°C.
Steel lever manual control. Two side 1/4" inlet - on with a plug.

R	P	A	L	M
1/2"	15	47	52	84
3/4"	20	58	60	98
1"	25	61	72	98

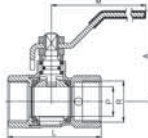

3032 04	1/2"	185	10-100	5,41
3032 05	3/4"	295	8-80	8,69
3032 06	1"	425	5-50	12,22



Ref. 3033



Válvula de esfera
 PN 25. Paso total. Construcción en latón UNE-EN 12165 cromado.
 Asientos PTFE. Extremos rosca gas (BSP) M-M - ISO 228/1.
 Temp. máx. 180°C. Mando manual por palanca acero.

Ball valve
 PN 25. Full bore. Body chrome plated brass UNE-EN 12165. PTFE
 seats. Gas threaded ends (BSP) M-M - ISO 228/1.
 Max. Temp. 180°C. Steel lever manual control.

R	P	A	L	M
1/2"	15	47	56	84
3/4"	20	58	65	98
1"	25	61	78	98

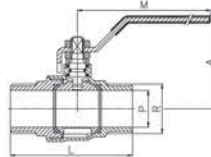

CÓDIGO CODE	MEDIDA SIZE	PESO WEIGHT	CAJA / BOX CARTON	P.V.P. € PRICE €
3033 04	1/2"	160	10-140	4,87
3033 05	3/4"	270	8-64	8,18
3033 06	1"	405	6-48	11,68

Ref. 3034



Válvula de esfera
 PN 25. Paso total. Construcción en latón UNE-EN 12165 cromado.
 Asientos PTFE. Extremos rosca gas (BSP) M-H - ISO 228/1.
 Temp. máx. 180°C. Mando manual por palanca acero.

Ball valve
 PN 25. Full bore. Body chrome plated brass UNE-EN 12165. PTFE
 seats. Gas threaded ends (BSP) M-F - ISO 228/1. Max. Temp. 180°C.
 Manual control lever steel handle

R	P	A	L	M
1/4"	10	46	48	84
3/8"	10	46	49	84
1/2"	15	47	55	84
3/4"	20	58	64	98
1"	25	61	76	98
1 1/4"	32	74	87	126
1 1/2"	40	80	95	126
2"	50	91	109	158

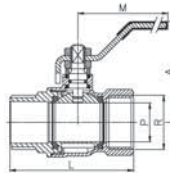

3034 02	1/4"	115	10-240	3,46
3034 03	3/8"	120	10-240	3,46
3034 04	1/2"	170	8-192	4,12
3034 05	3/4"	275	6-108	6,82
3034 06	1"	410	6-72	10,12
3034 07	1 1/4"	650	4-48	15,65
3034 08	1 1/2"	875	2-24	22,77
3034 09	2"	1370	2-18	34,41

Ref. 3035 - 3037



Válvula de esfera (3035 maneta azul - 3037 maneta roja)
 PN 25. Paso total. Construcción en latón UNE-EN 12165 cromado.
 Asiento PTFE. Extremos rosca gas (BSP) H-H - ISO 228/1.
 Temp. máx. 180°C. Mando manual por palomilla aluminio.

Ball valve (3035 blue handle - 3037 red handle)
 PN 25. Full bore. Body chrome plated brass UNE-EN 12165. PTFE
 seats. Gas threaded ends (BSP) F-F - ISO 228/1.
 Max. temp. 180°C. Aluminium butterfly handle.

R	P	A	L	M
1/4"	10	38	40	50
3/8"	10	38	43	50
1/2"	15	40	49	50
3/4"	20	50	56	62
1"	25	53	68	62

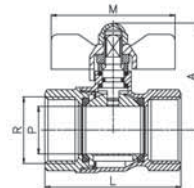

3035 02	1/4"	90	12-288	3,21
3035 03	3/8"	100	12-288	3,21
3035 04	1/2"	145	10-240	3,97
3035 05	3/4"	240	6-108	6,44
3035 06	1"	360	5-90	9,80
3037 02	1/4"	90	12-288	3,21
3037 03	3/8"	100	12-288	3,21
3037 04	1/2"	145	10-240	3,97
3037 05	3/4"	240	6-108	6,44
3037 06	1"	360	5-90	9,80

Ref. 3036 - 3038



Válvula de esfera (3036 maneta azul - 3038 maneta roja)
 PN 25. Paso total. Construcción en latón UNE-EN 12165 cromado.
 Asientos PTFE. Extremos rosca gas (BSP) M-H - ISO 228/1.
 Temp. máx. 180°C. Mando manual por palomilla aluminio.

Ball valve (3036 blue handle - 3038 red handle)
 PN 25. Full bore. Body chrome plated brass UNE-EN 12165. PTFE
 seats. Gas threaded ends M-F (BSP) - ISO 228/1.
 Max. temp. 180°C. Aluminium butterfly handle.

R	P	A	L	M
1/4"	10	38	48	50
3/8"	10	38	49	50
1/2"	15	40	56	50
3/4"	20	50	64	62
1"	25	53	76	62

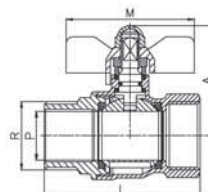

3036 02	1/4"	100	12-288	3,40
3036 03	3/8"	105	12-288	3,40
3036 04	1/2"	150	10-240	4,19
3036 05	3/4"	250	6-108	6,74
3036 06	1"	380	5-90	10,19
3038 02	1/4"	100	12-288	3,40
3038 03	3/8"	105	12-288	3,40
3038 04	1/2"	150	10-240	4,19
3038 05	3/4"	250	6-108	6,74
3038 06	1"	380	5-90	10,19

Ref. 3046



Válvula de esfera con racor dos piezas
 PN 25. Paso total. Construcción en latón UNE-EN 12165 cromado.
 Asientos PTFE. Extremos rosca gas (BSP) M-H ISO 228/1.
 Temp. máx. 180°C. Mando manual por palomilla aluminio.

Ball valve with 2 pieces connector
 PN 25. Full bore. Body chrome plated brass UNE-EN 12165.
 PTFE seats. Gas threaded ends (BSP) M-F - ISO 228/1.
 Max. Temp. 180°C. Aluminium butterfly handle.

R	P	A	L	M
1/2"	15	36	69	50
3/4"	20	44	76	62
1"	25	48	92	62
1 1/4"	30	57	106	78

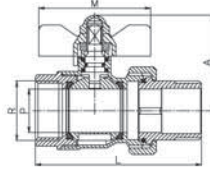

CÓDIGO CODE	MEDIDA SIZE	PESO WEIGHT	CAJA / BOX CARTON	P.V.P. € PRICE €
3046 04	1/2"	185	18-144	5,89
3046 05	3/4"	305	10-80	9,76
3046 06	1"	490	6-48	14,55
3046 07	1 1/4"	715	4-32	23,83

Ref. 3048



Válvula de esfera con racor dos piezas
 PN 25. Paso total. Construcción en latón UNE-EN 12165 cromado.
 Asientos PTFE. Extremos rosca gas (BSP) M-H - ISO 228/1.
 Temp. máx. 180°C. Mando manual por palanca de acero.

Ball valve with 2 pieces connector
 PN 25. Full bore. Body chrome plated brass UNE-EN 12165.
 PTFE seats. Gas threaded ends (BSP) M-F - ISO 228/1.
 Max. Temp. 180°C. Steel lever manual control.

R	DN	A	L	M
1/2"	15	47	69	84
3/4"	20	58	76	98
1"	25	61	92	98
1 1/4"	32	74	106	126
1 1/2"	40	80	119	126
2"	50	91	141	158

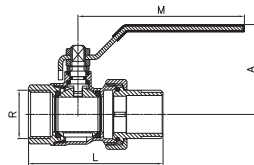

3048 04	1/2"	205	8-192	6,29
3048 05	3/4"	340	6-72	10,35
3048 06	1"	525	4-48	15,63
3048 07	1 1/4"	785	2-24	24,91
3048 08	1 1/2"	1145	2-24	39,09
3048 09	2"	1710	2-18	58,53

Ref. 3075



Válvula de esfera escuadra M-H con racor dos piezas
 PN 25. Paso total. Construcción en latón UNE-EN 12165 cromado.
 Asientos PTFE. Extremos rosca gas (BSP) M-H - ISO 228/1.
 Temp. máx. 180°C. Mando manual por palomilla aluminio.

Ball angle valve M-F with 2 pieces detachable connector
 PN 25. Full bore. Body chrome plated brass UNE-EN 12165.
 PTFE seats. Gas threaded end (BSP) M-F - ISO 228/1.
 Max. Temp. 180°C. Aluminium butterfly handle.

R	P	A	L	M
3/4"	20	87	58	62
1"	25	97	63	62

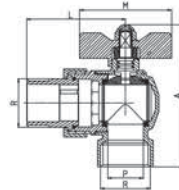

3075 05	3/4"	375	8-48	12,89
3075 06	1"	585	5-30	19,08

Ref. 3272 - 3282



Válvula esfera 3 vías montaje actuador Tipo "L" (3272) y Tipo "T" (3282)

PN 25. Paso total. Construcción en latón cromado UNE-EN 12165.
 Asientos PTFE. Extremos rosca gas (BSP) H - ISO 228/1. Obturador esférico en 2/3 vías en forma "L" / "T". Juntas NBR. Temp. máx. 120°C. Mando manual por palanca. Conexión a actuador ISO 5211.

Type "L" (3272) and Type "T" (3282) 3 ways ball valve direct mount (3272)

PN 25. Full bore. Body chrome plated brass UNE-EN 12165.
 PTFE seats. Gas threaded ends (BSP) F - ISO 228/1.
 2/3 ways spherical seal. "L" / "T" shape. NBR o-rings. Max. Temp. 120°C. Manual control lever. Actuator connection ISO 5211.

R	P	A	L	M	ISO 5211
1/2"	15	65	74	99	F03
3/4"	20	71	85	114	F04
1"	25	75	97	114	F04

ART.	TIPO	1	2	3	4
3272	L	1/2 3	1/2 3	1/2 3	1/2 3
3282	T	1/2 3	1/2 3	1/2 3	1/2 3

3272 04	1/2"	480	4-60	24,15
3272 05	3/4"	740	2-30	36,58
3272 06	1"	1095	2-24	57,89
3282 04	1/2"	475	4-60	24,06
3282 05	3/4"	730	2-30	36,94
3282 06	1"	1085	2-24	58,54

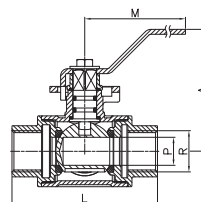

Ref. 3070 - 3080



● **Válvula esfera 3 vías tipo "L" (3070) y Tipo "T" (3080)**
 PN 25. Construcción en latón UNE-EN 12165 cromado. Asientos de PTFE. Extremos rosca gas (BSP) H - ISO 228/1. Obturador esférico en dos/tres vías en forma "L" / "T". Temp. máx. 120°C. Mando manual por palanca.

Type "L" (3070) and Type "T" (3080) 3 ways ball valve
 PN 25. Chrome plated brass UNE-EN 12165 body. 4 PTFE seats. Gas threaded ends (BSP) F - ISO 228/1. Spherical seal 2/3 ways type "L" / "T". Max. Temp. 120°C. Manual control lever.

R	P	A	L	M
1/4"	10	65	77	125
3/8"	12	65	77	125
1/2"	14	65	77	125
3/4"	18	85	92	145
1"	23	100	105	170
1 1/4"	29	100	118	170
1 1/2"	36	120	138	170
2"	45	130	162	260

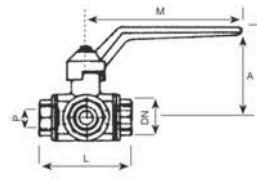

ART. TIPO	R	P	A	L	M
3070 L	1/2	2	1/2	2	1/2
3080 T	1/2	2	1/2	2	1/2

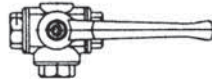

CÓDIGO CODE	MEDIDA SIZE	PESO WEIGHT	CAJA / BOX CARTON	P.V.P. € PRICE €
3070 02	1/4"	710	4-36	27,25
3070 03	3/8"	670	4-36	27,25
3070 04	1/2"	640	4-36	27,25
3070 05	3/4"	1100	2-18	41,39
3070 06	1"	1650	2-12	61,32
3070 07	1 1/4"	2250	2-12	95,07
3070 08	1 1/2"	3640	2-6	136,28
3070 09	2"	5700	2-4	200,87
3080 02	1/4"	708	4-36	27,25
3080 03	3/8"	665	4-36	27,25
3080 04	1/2"	635	4-36	27,25
3080 05	3/4"	1094	2-18	41,39
3080 06	1"	1642	2-12	61,32
3080 07	1 1/4"	2242	2-12	95,07
3080 08	1 1/2"	3630	2-6	136,28
3080 09	2"	5690	2-4	200,87

Ref. 3096



● **Válvula esfera mini**
 PN 16. Paso reducido. Construcción en latón y cromado UNE-EN 12165. Asientos PTFE. Extremos rosca gas (BSP) H-H - según ISO 228/1. Temp. máx. 140°C. Mando palomilla aluminio.

Mini ball valve
 PN 16. Reduced bore. Body chrome plated brass UNE-EN 12165. PTFE seats - female gas threaded ends (BSP) ISO 228/1. Max. Temp. 140°C. Butterfly handle operated aluminium.

R	P	A	L	M
1/8"	6,5	28	37	22
1/4"	6,5	28	39	22
3/8"	8	30	42	22
1/2"	10	33	46	22
3/4"	12,5	36	55	22

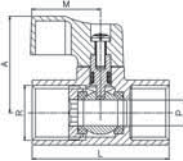

3096 01	1/8"	50	20-480	2,59
3096 02	1/4"	50	20-480	2,59
3096 03	3/8"	75	15-360	2,88
3096 04	1/2"	105	10-240	3,75
3096 05	3/4"	170	15-180	6,66

Ref. 3097



● **Válvula esfera mini**
 PN 16. Paso reducido. Construcción en latón y cromado UNE-EN 12165. Asientos PTFE. Extremos rosca gas (BSP) M-H - según ISO 228/1. Temp. máx. 140°C. Mando palomilla aluminio.

Mini ball valve
 PN 16. Reduced bore. Body chrome plated brass UNE-EN 12165. PTFE seats. M-F gas threaded ends (BSP) ISO 228/1. Max. Temp. 140°C. Butterfly handle operated aluminium.

R	P	A	L	M
1/8"	6,5	28	36	22
1/4"	6,5	28	37	22
3/8"	8	30	40	22
1/2"	10	33	44	22
3/4"	12,5	36	52	22

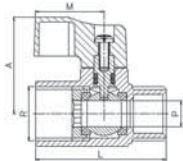

3097 01	1/8"	45	20-480	2,59
3097 02	1/4"	45	20-480	2,59
3097 03	3/8"	65	15-360	2,88
3097 04	1/2"	100	10-240	3,75
3097 05	3/4"	160	8-192	6,66

Ref. 3296



NOVEDAD
NEW

● **Válvula de esfera**
 PN40. Paso reducido. Construcción en latón y cromado UNE-EN 12165. Asientos PTFE. Extremo rosca gas (BSP) M - ISO 228/1 y conexión a manguera. Temp. máx. 140°C. Mando manual por palomilla de aluminio.

Ball valve
 PN40. Reduced bore. Body chrome plated brass UNE-EN 12165. PTFE seats. Gas threaded end (BSP) M - ISO 228/1 and hose connection. Max. Temp. 140°C. Butterfly handle operated aluminium.

R	P	A	M	L	B
1/2"	10	36	50	67	15

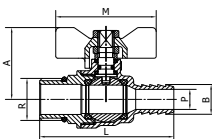

3296 04	1/2"	147	-	5,35
---------	------	-----	---	------

Ref. 3297



NOVEDAD
NEW

Válvula esfera mini
PN16. Paso reducido. Construcción en latón y cromado UNE-EN 12165. Asientos PTFE. Extremo rosca gas (BSP) M - ISO 228/1 y conexión a manguera. Temp. máx. 140°C. Mando manual por palomilla de aluminio.

Mini ball valve
PN16. Reduced bore. Body chrome plated brass UNE-EN 12165. PTFE seats. Gas threaded end (BSP) M - ISO 228/1. and hose connection. Max. Temp. 140°C. Butterfly handle operated aluminium.

R	P	A	M	L	B
1/2"	8	32	22	60	15

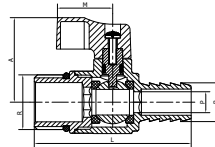

CÓDIGO CODE	MEDIDA SIZE	PESO WEIGHT	CAJA / BOX CARTON	P.V.P. € PRICE €
3297 04	1/2"	104	-	4,73

Ref. 3396



Válvula esfera mini
PN 16. Paso reducido. Construcción en latón UNE-EN 12165. Asientos PTFE. Barra hexagonal cromada. Extremos rosca gas (BSP) H-H según ISO 228/1. Temp. máx. 140°C. Mando palomilla aluminio.

Mini ball valve
PN 16. Reduced bore. Hexagonal body chrome plated brass UNE-EN 12165. PTFE seats - female gas threaded ends (BSP) ISO 228/1. Max. Temp. 140°C. Butterfly handle operated aluminium.

R	P	A	L	M
1/8"	6	26	37	23
1/4"	8	26	40	23
3/8"	8	27	42	23
1/2"	10	28	45	23
3/4"	12	30	53	23

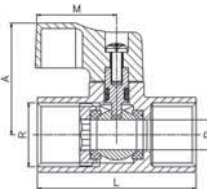

3396 01	1/8"	90	15-360	3,45
3396 02	1/4"	90	15-360	3,45
3396 03	3/8"	80	15-360	3,45
3396 04	1/2"	105	10-240	4,21
3396 05	3/4"	185	8-192	8,06

Ref. 3397



Válvula esfera mini
PN 16. Paso reducido. Construcción en latón UNE-EN 12165. Asientos PTFE. Barra hexagonal cromada. Extremos rosca gas (BSP) M-H - según ISO 228/1. Temp. máx. 140°C. Mando palomilla aluminio.

Mini ball valve
PN 16. Reduced bore. Hexagonal body chrome plated brass UNE-EN 12165. PTFE seats. M-F gas threaded ends (BSP) ISO 228/1. Max. Temp. 140°C. Butterfly handle operated aluminium.

R	P	A	L	M
1/8"	6	26	37	23
1/4"	8	26	40	23
3/8"	8	27	41	23
1/2"	10	28	45	23
3/4"	12	30	53	23

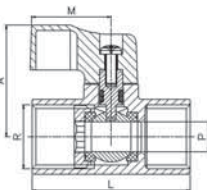

3397 01	1/8"	70	15-360	3,45
3397 02	1/4"	75	15-360	3,45
3397 03	3/8"	70	15-360	3,45
3397 04	1/2"	100	10-240	4,21
3397 05	3/4"	175	15-180	8,06

Ref. 3044



Válvula de descarga para caldera
PN 25. Paso total. Construcción en latón UNE-EN 12165 cromado. Asientos PTFE. Extremos rosca gas (BSP) M ISO 228/1 y conexión a manguera Ø 15 con tapón seguridad. Temp. máx. 180°C. Mando manual por palomilla aluminio.

Boiler discharge valve
PN 25. Full bore. Body brass UNE-EN 12165. PTFE seats. Threaded end male ISO 228/1 and Ø 15 hose connection with safety cap. Max. Temp. 180°C. Aluminium butterfly handle.

R x B	DN	H	L	M
G 1/2" x Ø15	10	34	72	35,5

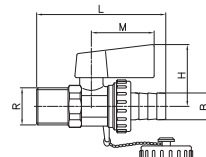

3044 04	1/2" x Ø15	145	8-192	4,71
---------	------------	-----	-------	------

Ref. 3081



Válvula esfera soldar
PN-16. Paso total. Construcción en latón UNE-EN 12165. Asientos PTFE. Extremos para soldar. Temp. máx. 180°C. Mando manual por palanca acero.

Welding ball valve
PN 16. Full bore. Body brass UNE-EN 12165. PTFE seats. Welded ends. Max. Temp. 180°C. Steel lever manual control.

D	DN	A	L	M
Ø15	12	46	57	84
Ø18	15	47	64	84
Ø22	20	58	72	98
Ø28	25	61	85	98
Ø35	32	75	96	135
Ø42	40	80	115	135
Ø54	50	90	140	165

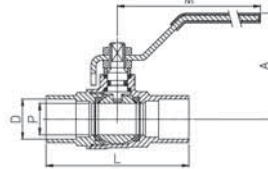

CÓDIGO CODE	MEDIDA SIZE	PESO WEIGHT	CAJA / BOX CARTON	P.V.P. € PRICE €
3081 15	Ø15	135	12-192	3,88
3081 18	Ø18	165	10-160	4,37
3081 22	Ø22	265	8-96	7,11
3081 28	Ø28	380	6-72	10,31
3081 35	Ø35	825	2-36	17,52
3081 42	Ø42	1170	1-18	26,83
3081 54	Ø54	1850	1-12	43,54

Ref. 3082



Válvula esfera soldar
PN-16. Paso total. Construcción en latón según UNE-EN 12165. Asientos PTFE. Extremos para soldar. Temp. máx. 180°C. Mando manual por palomilla aluminio.

Welding ball valve
PN 16. Full bore. Body brass UNE-EN 12165. PTFE seats. Welded ends. Max. Temp. 180°C. Aluminium butterfly handle operated.

D	DN	A	L	M
Ø15	12	39	57	50
Ø18	15	40	64	50
Ø22	20	50	72	62

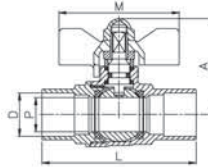

3082 15	Ø15	115	10-240	3,77
3082 18	Ø18	145	8-192	4,46
3082 22	Ø22	230	5-120	7,04

Ref. K3000



ART. K3000
Kit prolongador
Distanciadore de palanca en latón según UNE-EN 12165 cromado. Para aplicar a los artículos indicados en la siguiente tabla.

Extension kit
Lever spacer in chromed brass UNE-EN 12165. For use of the items indicated in the table below.

Ref.	X (mm)	3020, 3021, 3022, 3029, 3032, 3033, 3034	3081
k3000 00	39	1/4" - 3/8"	-
k3000 01	39	1/2"	Ø15- Ø18
k3000 02	40	3/4" - 1"	Ø22- Ø28
k3000 03	51	1 1/4" - 1 1/2"	Ø35- Ø42
k3000 04	55	2" - 2 1/2"	Ø54

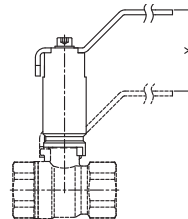

K3000 00	-	65	25-600	2,99
K3000 01	-	65	25-600	3,06
K3000 02	-	90	20-480	4,36
K3000 03	-	155	10-240	6,35
K3000 04	-	240	10-240	9,92

Ref. 3234



Válvula esfera prolongada para aislamiento
PN 25. Paso total. Construcción en latón UNE-EN 12165. Asientos PTFE y juntas NBR. Extremos rosca gas (BSP) H-H - ISO 228/1. Temp. máx. 110°C. Mando manual palanca acero.

Ball valve with extension for isolation
PN 25. Full bore. Brass construction UNE-EN 12165. PTFE seats and NBR joints. Gas threaded ends (BSP) F-F - ISO 228/1. Max. Temp. 110°C. Steel lever handle.

R	DN	L	A	M
G 1/2"	15	49	81,5	84
G 3/4"	20	56	85,5	84

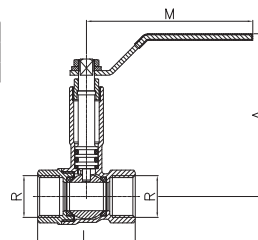

3234 04	1/2"	205	5-90	8,02
3234 05	3/4"	275	4-72	10,86

Precios a consultar / Prices on request

Ref. 3235



● **Válvula esfera prolongada para aislamiento**
 PN 25. Paso total. Construcción en latón UNE-EN 12165. Asientos PTFE y juntas NBR. Extremos rosca gas (BSP) H-H - ISO 228/1. Temp. máx. 110°C. Mando manual palomilla aluminio.

Ball valve with extension for isolation
 PN 25. Full bore. Brass construction UNE-EN 12165. PTFE seats and NBR joints. Gas threaded ends (BSP) F-F - ISO 228/1. Max. Temp. 110°C. Aluminium butterfly handle.

R	DN	L	A	M
G 1/2"	15	49	75	50
G 3/4"	20	56	78	50

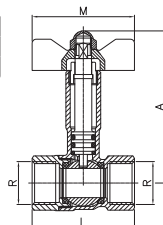

CÓDIGO CODE	MEDIDA SIZE	PESO WEIGHT	CAJA / BOX CARTON	P.V.P. € PRICE €
3235 04	1/2"	185	5-120	8,02
3235 05	3/4"	260	4-96	10,86

Ref. 3056



● **Válvula de esfera empotrar rosca gas**
 PN-25. Paso total. Construcción en latón según UNE-EN 12165. Asientos PTFE. Extremos roscados gas (BSP) H-H ISO 228/1. Temp. máx. 150 °C.

Built-in gas threaded ball valve
 PN 25. Full bore. Body brass UNE-EN 12165. PTFE seats. Gas threaded ends (BSP) F-F - ISO 228/1. Max. Temp. 150°C.

R	P	A	L
1/2"	15	79	49
3/4"	20	82	56
1"	25	86	68

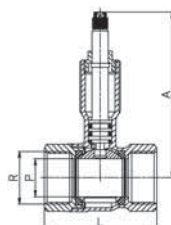

3056 04	1/2"	180	15-120	6,01
3056 05	3/4"	250	12-96	8,15
3056 06	1"	375	6-48	12,91

Ref. 3083



● **Válvula de esfera empotrar soldar**
 PN-16. Paso total. Construcción en latón según UNE-EN 12165. Asientos PTFE. Extremos para soldar. Temp. máx. 150°C.

Built-in ball valve - welded ends
 PN 16. Full bore. Body brass UNE-EN 12165. PTFE seats. Welding ends. Max. Temp. 150°C.

D	P	A	L
15	12	78	57
18	15	79	64
22	20	82	72

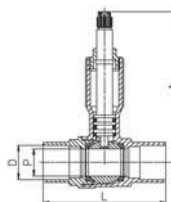

3083 15	Ø15	155	12-144	5,88
3083 18	Ø18	185	8-96	6,26
3083 22	Ø22	250	10-80	7,94

Ref. 3181



● **Válvula empotrar tubería polibutileno con casquillos**
 PN 25. Paso total. Construcción en latón según UNE-EN 12165. Asientos PTFE. Conexión a tubería mediante racor de plástico. Temp. máx. 110 °C.

Built-in valve pipe polybutylene with sockets
 PN 25. Full bore. Body brass UNE-EN 12165. PTFE seats. Connected to pipe by a plastic connector. Max. Temp. 110°C.

Ø Tuba/ Pipe	P	L	A
Ø15	12	78	77
Ø22	19,5	86	82

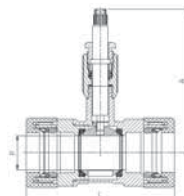

3181 15	Ø15	267	12-168	15,90
3181 22	Ø22	401	8-64	26,14

Ref. 3183

● **Válvula empotrar tubería pex y multicapa con casquillos PN 25.** Paso total. Construcción en latón cromado según UNE-EN 12165. Asientos PTFE. Juntas EPDM. Temp. máx. 110°C.

Built-in valve pex and multilayer pipe with sockets PN 25. Full bore. Body chrome plated brass UNE-EN 12165. PTFE seats. EPDM joints. Max. Temp. 110°C.



Ø Tubo/ Pipe	P	A	L
Ø16x2	8	72	78
Ø20x2	12	80	79
Ø25x2,5	15	97	83
Ø32x3	20	98	83

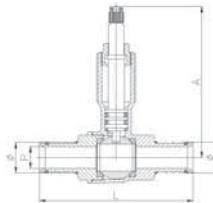

CÓDIGO CODE	MEDIDA SIZE	PESO WEIGHT	CAJA / BOX CARTON	P.V.P. € PRICE €
3183 16	Ø16x2	180	-	6,35
3183 20	Ø20x2	220	-	7,60
3183 25	Ø25x2,5	330	-	11,12
3183 32	Ø32x3	370	-	13,36

Ref. 3184

● **Válvula empotrar en "U" tubería pex y multicapa con casquillos PN 25.** Paso estándar. Construcción en latón cromado según UNE-EN 12165. Asientos PTFE. Juntas EPDM. Temp. máx. 110°C.

"U" built-in ball valve pex and multilayer pipe with sockets PN 25. Standard bore. Body chrome plated brass UNE-EN 12165. PTFE seats. EPDM joints. Max. Temp. 110°C.



Ø Tubo/ Pipe	L	A	B	C	D
Ø20x2	70	77	36	36	40
Ø25x2,5	87	80	46	36	50

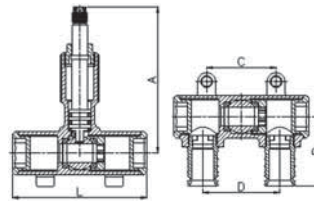

3184 20	Ø20x2	305	-	13,07
3184 25	Ø25x2,5	475	-	21,44

Ref. P3052

● **Pomo con florón mod. "gora"**

Pomo adaptable a todas las medidas de nuestras válvulas 3056 - 3083 - 3181 - 3183 y 3184. Construcción de pomo y florón en zamak - acabado cromado pulido.

"Gora" handle with cover
Handle adaptable to all sizes of our valves 3056 - 3083 - 3181 - 3183 and 3184. Zamak handle body and cover - polished chromed.

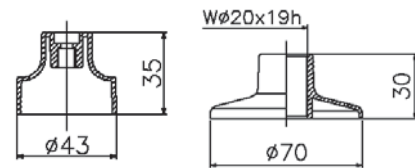

P3052	-	136	15-180	4,40
-------	---	-----	--------	------

Ref. MKalo

● **Maneta con florón mod. "Kalo"**

Maneta adaptable a todas las medidas de nuestras válvulas 3056 - 3083 - 3181 - 3183 y 3184. Construcción de maneta y florón en zamak - acabado cromado y pulido. Con refuerzo en el aro de sujeción al grafilado del eje.

"Kalo" handle with cover
Handle adaptable to all sizes of our valves 3056 - 3083 - 3181 - 3183 and 3184. Zamak handle body and cover - polished chromed. Reinforced fastening ring stem.

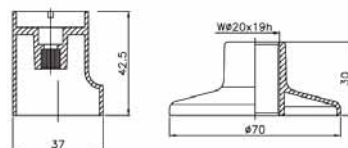

NOVEDAD
NEW

MKalo	-	190	-	11,97
-------	---	-----	---	-------

Ref. MKross



NOVEDAD
NEW

Maneta con florón mod. "Kross"

Maneta adaptable a todas las medidas de nuestras válvulas 3056, 3083, 3181, 3183 y 3184. Construcción de maneta y florón en zamak, acabado cromado y pulido. Con refuerzo en el aro de sujeción al grafilado del eje.

"Kross" handle with cover

Handle adaptable to all sizes of our valves 3056, 3083, 3181, 3183 and 3184. Zamak handle body and cover, polished chromed. Reinforced fastening ring stem.

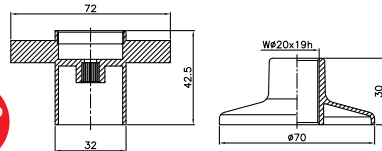

CÓDIGO CODE	MEDIDA SIZE	PESO WEIGHT	CAJA / BOX CARTON	P.V.P. € PRICE €
MKross	-	240	-	10,70

Ref. M3055



Maneta con florón

Maneta adaptable a todas las medidas de nuestras válvulas 3056, 3083, 3181, 3183 y 3184. Construcción de maneta y florón en zamak, acabado cromado pulido. Con refuerzo en el aro de sujeción al grafilado del eje.

Handle with cover

Handle adaptable to all sizes of our valves 3056, 3083, 3181, 3183 and 3184. Zamak handle body and cover, polished chromed. Reinforced fastening ring stem.

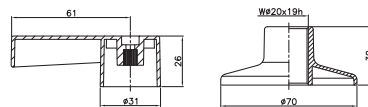

M3055	-	130	15-180	4,61
-------	---	-----	--------	------

Precios a consultar / Prices on request

Ref. M3054



Mando oculto

Permite ocultar eje accionador de llaves de paso empotradas. Construcción de pomo en latón según UNE-EN 12165 acabado cromado pulido. Construcción de florón en zamak acabado cromado pulido.

Hidden control

Activating stem of the built-in shut off valve can be hidden. Polished chromed brass handle UNE-EN 12165. Zamak cover, polished chromed.

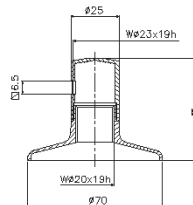

M3054	-	98	15-180	5,32
-------	---	----	--------	------

Ref. M3057



NOVEDAD
NEW

Maneta con florón

Maneta adaptable a todas las medidas de nuestras válvulas 3056, 3083, 3181, 3183 y 3184. Construcción de maneta y florón en zamak, acabado cromado y pulido. Con refuerzo en el aro de sujeción al grafilado del eje.

Handle with cover

Handle adaptable to all sizes of our valves 3056, 3083, 3181, 3183 and 3184. Zamak handle body and cover, polished chromed. Reinforced fastening ring stem.

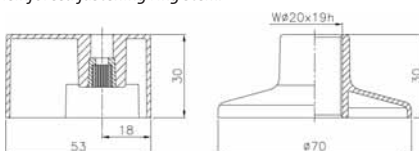

M3057	-	130	-	5,08
-------	---	-----	---	------

Ref. K3052

- **Kit prolongador válvulas empotrar**
Permite alargar el eje de las válvulas en caso necesario. Construcción de alargó en latón según UNE-EN 12165. Construcción de florón en zamak - cromado y pulido.



Stretcher kit built-in-valves
Valve stem can be stretched if needed. Stretcher body brass UNE-EN 12165. Zamak cover polished chromed.

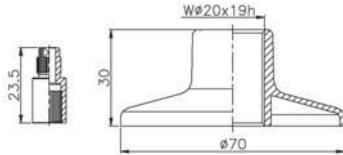

CÓDIGO CODE	MEDIDA SIZE	PESO WEIGHT	CAJA / BOX CARTON	P.V.P. € PRICE €
K3052	-	110	15-180	3,35

Ref. 3061

- **Válvula manguera con dos salidas giratorias independientes**
PN 16. Paso total. Construcción en latón UNE-EN 12165 cromado y pulido. Asientos PTFE. Entrada rosca gas (BSP) M - ISO 228/1. Temp. máx. 180°C. Una salida racor Rapid-Ge conexión manguera. Salidas giratorias 360° e independientes una de la otra.



Bibcock valve with two independent outlet
PN 16. Full bore. Body chrome plated brass UNE-EN 12165 - chromed polished. PTFE seats. Gas threaded inlet (BSP) M - ISO 228/1. Max. Temp. 180°C. Butterfly handle operated. 1 Rapid-Ge outlet. Lever operated 360° outlets - independent from each other and rotatory.

r	R	L	A
1/2"	3/4"	115	65

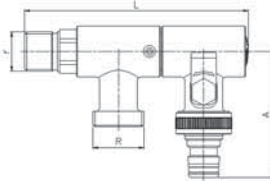

3061 04	1/2"x3/4"	390	1-60	18,05
---------	-----------	-----	------	-------

Ref. 3062

- **Válvula manguera con dos salidas independientes sin racor**
PN16. Paso estándar. Construcción en latón UNE-EN 12165 cromado y pulido. Mandos en ABS 1/4 vuelta. Cierre central eje excéntrico (sistema Genebre) y cierre lateral mediante esfera. Extremos roscados gas (BSP) M ISO 228/1. Temp. máx. 120°C.



Bibcock valve with two independent outlet without hose connection
PN16. Standard bore. Forged brass body UNE-EN 12165 chromed polished. ABS 1/4 turn handles. Eccentric stem central closing (system Genebre) and ball lateral closing. Gas threaded ends (BSP) M ISO 228/1. Max. temp. 120°C.

R	r1	r2
1/2"	1/2"	3/8"
1/2"	1/2"	1/2"
1/2"	3/4"	3/8"
1/2"	3/4"	1/2"
1/2"	3/4"	3/4"

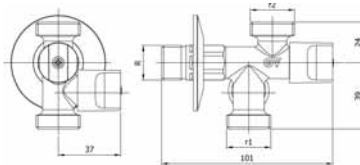

NOVEDAD
NEW

3062 04 03	1/2" x 1/2" x 3/8"	163	-	10,78
3062 04 04	1/2" x 1/2" x 1/2"	167	-	10,78
3062 05 03	1/2" x 3/4" x 3/8"	169	-	10,78
3062 05 04	1/2" x 3/4" x 1/2"	173	-	10,78
3062 05 05	1/2" x 3/4" x 3/4"	178	-	10,78

Ref. 3062R

- **Válvula manguera con dos salidas independientes con Rapid-Ge conexión manguera**
PN16. Paso estándar. Construcción en latón UNE-EN 12165 cromado y pulido. Mandos en ABS 1/4 vuelta. Cierre central eje excéntrico (sistema Genebre) y cierre lateral mediante esfera. Extremos roscados gas (BSP) M ISO 228/1. Una salida racor Rapid-Ge conexión manguera. Temp. máx. 120°C.



Bibcock valve with two independent outlet with Rapid-Ge hose connection
PN16. Standard bore. Forged brass body UNE-EN 12165 chromed polished. ABS 1/4 turn handles. Eccentric stem central closing (system Genebre) and ball lateral closing. Gas threaded ends (BSP) M ISO 228/1. One outlet with Rapid-Ge hose connection. Max. temp. 120°C.

R	r1
1/2"	3/4"

3062R 05 05	1/2" x 3/4" x 3/4"	210	-	12,23
-------------	--------------------	-----	---	-------

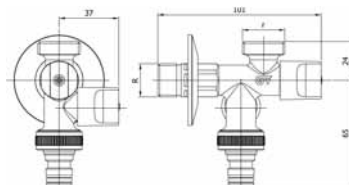

NOVEDAD
NEW

Ref. 3059



Válvula de esfera para manguera
 PN 16. Paso total. Construcción en latón UNE-EN 12165 cromado. Asientos PTFE. Entrada rosca gas (BSP) M - ISO 228/1. Salida racor dos piezas conexión manguera. Temp. máx. 100°C. Mando palanca.

Bibcock ball valve
 PN 16. Full bore. Body chrome plated brass UNE-EN 12165. PTFE seats. Male gas threaded ends - ISO 228/1 and 2 pieces hose connection. Max. temp. 100 °C. Manual control lever.

R	P	A	L	M
1/2"x3/4"	10	88	85	84
3/4"x1"	12	95	95	84
1"x1"	15	112	119	98

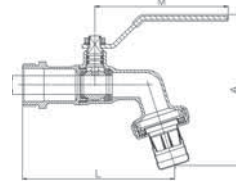

CÓDIGO CODE	MEDIDA SIZE	PESO WEIGHT	CAJA / BOX CARTON	P.V.P. € PRICE €
3059 04	1/2"x3/4"	155	16-192	3,97
3059 05	3/4"x1"	210	10-120	5,39
3059 06	1"x1"	325	6-72	8,36

Ref. 3059R



Válvula de esfera para manguera
 PN 16. Construcción en latón UNE-EN 12165 cromado. Asientos PTFE. Extremos rosca gas (BSP) M - ISO 228/1. Salida racor dos piezas conexión manguera. Temp. máx. 100°C. Mando manual por palanca de acero.

Bibcock ball valve
 PN 16. Body chrome plated brass UNE-EN 12165. PTFE seats. Gas threaded ends (BSP) M - ISO 228/1. 2 pieces hose connection outlet. Max. Temp. 100°C. Steel lever manual control.

R	P	A	L	M
1/2"x1/2"	9,5	89	85	84
3/4"x3/4"	9,5	89	86	84

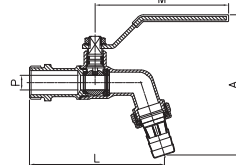

3059R 04	1/2"x1/2"	150	16 - 196	4,13
3059R 05	3/4"x3/4"	160	10 - 120	5,26

Ref. 3060F



Válvula de esfera para manguera Rapid-Ge
Con sistema Anti - Hielo
 PN 16. Paso total. Construcción en latón UNE-EN 12165 cromado. Asientos PTFE. Entrada rosca gas (BSP) M - ISO 228/1. Salida racor Rapid-Ge conexión manguera. Temp. max. 100°C. Mando manual por palanca de acero Inox. Orificio de descompresión Anti - Hielo.

Bibcock "Rapid-Ge" ball valve with antifreeze system
 PN 16. Body chrome plated brass UNE-EN 12165. PTFE seats. Gas threaded ends (BSP) M - ISO 228/1. Outlet with Rapid-Ge hose connection. Max. Temp. 100°C. Stainless Steel lever manual control. Antifreeze decompression hole

R	P	A	L	M
1/2" x 3/4"	10	93	92	84

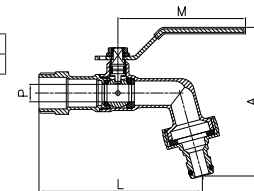

NOVEDAD
NEW

3060F 04	1/2" x 3/4"	195	12-144	9,81
----------	-------------	-----	--------	------

Ref. 3060



Válvula de esfera para manguera Rapid-Ge
 PN 16. Paso total. Construcción en latón UNE-EN 12165 cromado. Asientos PTFE. Entrada rosca gas (BSP) M - ISO 228/1. Salida racor Rapid - Ge conexión manguera. Temp. máx. 100°C. Mando palanca acero inox. Precintable en posición de apertura y cierre.

Bibcock "Rapid-Ge" ball valve
 PN 16. Full bore. Body chrome plated brass UNE-EN 12165 . PTFE seats. Gas threaded ends (BSP) M - ISO 228/1 and 2 pieces hose connection. Rapid-Ge outlet. Max. temp. 100 °C. Stainless steel handle. Lockable in open and close position.

R	P	A	L	M
1/2" x 3/4"	10	93	92	84
3/4" x 1"	12	98	108	84
1" x 1"	15	103	116	98

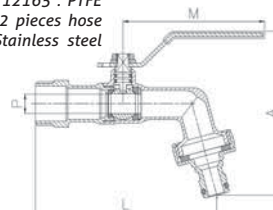

3060 04	1/2"x3/4"	195	12-144	6,74
3060 05	3/4"x1"	265	8-96	8,74
3060 06	1"x1"	330	6-72	10,88

Ref. 3066



Válvula de esfera para manguera T-handle Rapid - Ge
 PN 16. Paso total. Construcción en latón UNE-EN 12165 cromado. Asientos PTFE. Entrada rosca gas (BSP) macho - ISO 228/1. Salida racor Rapid-Ge conexión manguera. Temp. máx. 100°C. Accionamiento mediante T- handle.

Bibcock ball T-handle valve "Rapid - Ge"
 PN 16. Full bore. Body chrome plated brass UNE-EN 12165. PTFE seats. Male gas threaded (BSP) inlet ISO 228/1. Rapid-Ge outlet connector. Max. temp. 100 °C. T- handle operated.

R	P	A	L	M
1/2"x3/4"	10	98	86	62
3/4"x1"	12	104	96	62

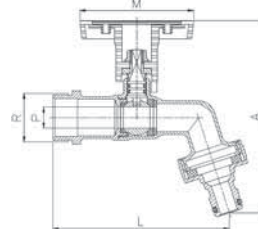

CÓDIGO CODE	MEDIDA SIZE	PESO WEIGHT	CAJA / BOX CARTON	P.V.P. € PRICE €
3066 04	1/2"x3/4"	165	12-144	7,23
3066 05	3/4"x1"	230	10-120	9,23

Ref. 3066B



Válvula de esfera para manguera
 PN 16. Paso total. Construcción en latón UNE-EN 12165 cromado pulido. Asientos PTFE. Entrada rosca gas (BSP) macho - ISO 228/1. Salida racor manguera dos piezas. Temp. máx. 100°C. Mando mediante palomilla.

Bibcock ball valve
 PN 16. Full bore. Body chrome plated brass UNE-EN 12165. PTFE seats. Male gas threaded end (BSP) ISO 228/1. 2 pieces hose connection outlet. Max. temp. 100 °C. Butterfly handle operated.

R	P	A	L	M
1/2"x3/4"	10	82	85	50
3/4"x1"	12	88	95	50

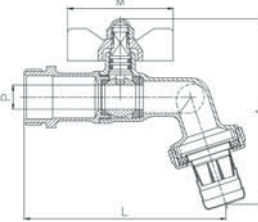

3066B 04	1/2"x3/4"	135	15-180	4,19
3066B 05	3/4"x1"	190	8-96	5,64

Ref. 3063



Válvula de esfera para manguera inox.
 Válvula de esfera para manguera inox. PN 16. Paso total. Construcción en acero inox. AISI 316. Asientos PTFE. Entrada rosca gas (BSP) M - ISO 228/1. Salida racor 2 piezas conexión manguera. Temp. máx. 100°C. Mando palanca de acero inoxidable.

Bibcock inox ball valve
 PN 16. Full bore. Stainless steel AISI 316 construction. PTFE seats. Male gas threaded (BSP) inlet - ISO 228/1. 2 pieces hose connection outlet. Max.Temp. 100°C. Stainless steel manual control lever.

R	P	A	L	M
1/2" x 3/4"	9,5	93	93	96

3063 04	1/2"x3/4"	200	15-90	15,33
---------	-----------	-----	-------	-------

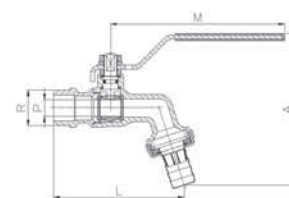

Ref. 3064



Válvula de esfera boca de riego vertical
 PN 16. Paso total. Construcción en latón UNE-EN 12165. Asientos PTFE. Entrada rosca gas (BSP) macho - ISO 228/1. Salida racor Rapid-Ge conexión manguera. Temp. máx. 100°C. Accionamiento mediante T- handle.

Vertical water hydrant ball valve
 PN 16. Full bore. Body chrome plated brass UNE-EN 12165. PTFE seats. Gas threaded (BSP) male inlet ISO 228/1. "Rapid- Ge" connector outlet. Max. temp. 100°C. T- handle operated.

R	P	A	L	M
1/2"x3/4"	13	55	100	62
3/4"x1"	15	58	102	62
1"x1"	19	72	130	82

3064 04	1/2"x3/4"	250	12-144	9,43
3064 05	3/4"x1"	330	10-120	11,75
3064 06	1"x1"	470	5-60	16,64

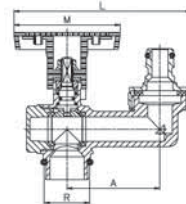

Ref. 3065



"Garden box" Válvula de esfera boca de riego vertical con caja y tapa
Mismas características que ref.3064 y arqueta con tapa color verde. Mando con la máxima altura para facilitar la apertura y cierre de la válvula.

"Garden box" water hydrant ball valve with cover
Same characteristics as ref. 3064 and green box - maximum height control to facilitate opening and closing of the valve rapid-ge connector.

R	P	A	ØL	B
3/4"x3/4"	10	102	190	124
3/4"x1"	10	102	190	124

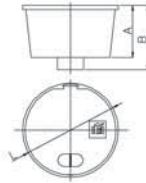

CÓDIGO CODE	MEDIDA SIZE	PESO WEIGHT	CAJA / BOX CARTON	P.V.P. € PRICE €
3065 04	1/2"x3/4"	775	1-12	43,66
3065 05	3/4"x1"	820	1-12	47,40

Ref. 3217



Conexión de manguera "Turbojet"
Conexión rosca tuerca loca hembra 3/4" ISO 228/1. Accionamiento manual por palanca de acero. Alta presión. Incluye 2 boquillas: función chorro y función lluvia. Longitud total 76 cm.

"Turbojet" hose connection
Connection thread female free nut 3/4" ISO 228/1. Steel manual control lever. High pressure. Includes 2 nozzles: stream and rain function. Total length 76cm.

3217 00	3/4"	450	6 U.	18,70
3217 00	3/4"	450	48 U.	16,83
3217 00	3/4"	450	300 U.	14,03

Precio unitario / Unit price.

Ref. R360



Racor manguera convencional
Adaptable a todas la series de grifos manguera. Construcción en latón según UNE-EN 12165 acabado cromado pulido. Presencia de difusor plástico para optimizar la homogeneidad de chorro.

Conventional hose connector
Adaptable to all kind of hose taps. Body chrome plated brass UNE-EN 12165 - polished. Plastic diffuser to make the liquid stream optimum and homogeneous.

r	ØD	A
3/4"	15	31
1"	20,5	33
1"	26,5	42

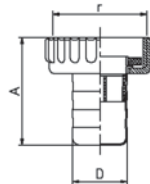

R360 04	3/4"x15	14	50-600	1,35
R360 05	1"x20,5	23	50-600	1,64
R360 06	1"x26,5	45	25-300	2,91

Ref. 3211



Racor hembra rapid-Ge cromado
Sistema de anclaje adaptable a enchufe 3215. Construcción en latón según UNE-EN 12165 acabado cromado pulido.

Rapid-Ge quick female connector
Anchoring system adaptable to switch 3215. Body chrome plated brass UNE-EN 12165 - polished.

R	P	A	L
3/4"	9,5	34	28,5
1"	9,5	34	35,7

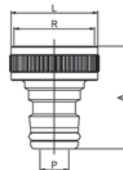

3211 05	3/4"	35	40-800	1,70
3211 06	1"	48	30-360	2,34

Ref. 3215

● **Enchufe manguera Rapid-Ge**

Sistema convencional de anclaje adaptable a racor 3210/ 3211. Construcción en latón según UNE-EN 12165.



Quick rapid-ge hose switch

Conventional anchoring system adaptable to connector 3210/ 3211. Body brass UNE-EN 12165.

ØA	L	Ø Max. Tubo
31,5	44	18
36	50	26

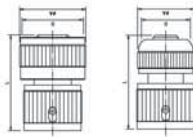

CÓDIGO CODE	MEDIDA SIZE	PESO WEIGHT	CAJA / BOX CARTON	P.V.P. € PRICE €
3215 05	Ø 18	75	20-240	5,68
3215 06	Ø 26	105	20-240	6,88

Ref. 3068

● **Válvula de esfera barril**

PN 16. Construcción en latón UNE-EN 12165 acabado pulido cromado. Asientos PTFE. Entrada rosca gas (BSP) macho - ISO 228/1. Temp. máx. 100°C. Mando manual por palomilla de aluminio.



Barrel ball valve

PN 16. Body chrome plated brass UNE-EN 12165 - polished. PTFE seats. Male gas threaded (BSP) inlet - ISO 228/1. Max. Temp. 100°C. Aluminium butterfly handle.

R	DN	P	A	L	M
1/2"	7,5	9,5	75	77	50
3/4"	8,5	11,5	84	90	50

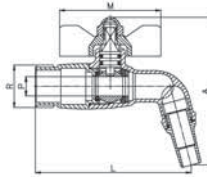

3068 04	1/2"	125	12-216	6,22
3068 05	3/4"	185	8-144	7,79

Ref. 2918

● **Válvula de esfera para barril**

PN 16. Paso red. Construcción en acero inox - AISI 316. Entrada rosca gas (BSP) macho según ISO 228/1. Temp. máx. 100°C. Accionamiento mediante palomilla.



Barrel ball valve

PN 16. Reduced bore. Body stainless steel AISI 316. Male gas threaded (BSP) inlet ISO 228/1. Max. temp. 100°C. Butterfly handle operated.

R	PN	A	L	M
3/8"	16	34	85	50
1/2"	16	34	85	50
3/4"	16	43	106	63

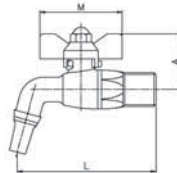

2918 03	3/8"	185	10-140	20,00
2918 04	1/2"	174	8-112	20,00
2918 05	3/4"	331	4-56	30,00

Ref. 2919

● **Válvula de esfera para barril**

PN 16. Paso red. Construcción en acero inox - AISI 316. Entrada rosca cónica macho. Temp. máx. 100°C. Accionamiento mediante palomilla.



Barrel ball valve

PN 16. Reduced bore. Body stainless steel AISI 316. Male threaded conical inlet. Max. Temp. 100°C. Butterfly handle operated.

R	PN	A	L	M
1/2"	16	34	97	50
3/4"	16	43	130	63

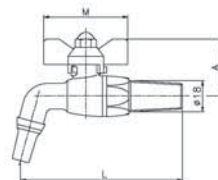

2919 04	1/2"	186	8-64	21,00
2919 05	3/4"	380	4-56	32,47

Ref. 3094



Válvula escuadra "Isis"

PN 10. Paso estándar. Mando ABS 1/4 de vuelta. Construcción en latón cromado según UNE-EN 12165. Extremos roscados gas (BSP) M-M en escuadra ISO 228/1. Temp. máx. 120°C. Cierre mediante eje excéntrico - sistema Genebre.

"Isis" angle valve

PN 10. Standard bore. ABS 1/4 turn handle. Chromed forged brass body UNE-EN 12165. Gas threaded ends (BSP) M-M ISO 228/1. Max. temp. 120°C. Genebre patented eccentric stem closing system.

R	P	L	D
1/2"x3/8"	6	83	50
1/2"x1/2"	6	83	50

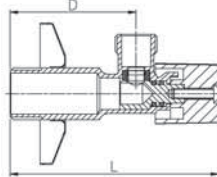

CÓDIGO CODE	MEDIDA SIZE	PESO WEIGHT	CAJA / BOX CARTON	P.V.P. € PRICE €
3094 04	1/2"x3/8"	80	2-240	2,83
3094 05	1/2"x1/2"	85	2-240	2,98

Ref. 3094E



Válvula escuadra económica

PN 10. Paso estándar. Construcción en latón UNE-EN 12165 cromado. Mando ABS 1/4 vuelta. Extremos rosca gas (BSP) M-M - ISO 228/1. Temp. máx. 120°C. Cierre en NBR.

Economic angle valve

PN 10. Standard bore. Chrome plated brass construction UNE-EN 12165. ABS 1/4 turn handle. Gas threaded ends (BSP) M-M - ISO 228/1. Max. Temp. 120°C. NBR sealing.

R	P	L	D
1/2"x3/8"	5,5	78	45
1/2"x1/2"	5,5	78	45

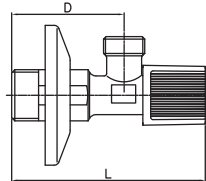

3094E 04	1/2"x3/8"	80	2-240	2,34
3094E 05	1/2"x1/2"	85	2-240	2,48

Ref. 3294



Válvula escuadra alargada

PN 10. Paso estándar. Construcción en latón UNE-EN 12165 cromado. Mando ABS 1/4 vuelta. Extremos roscados gas (BSP) M-M - ISO 228/1. Temp. máx. 120°C. Cierre mediante eje excéntrico (sistema Genebre).

Longer angle valve

PN 10. Standard bore. Chrome plated brass construction UNE-EN 12165. ABS 1/4 turn handle. Gas threaded ends (BSP) M-M - ISO 228/1. Max. Temp. 120°C. Closing by eccentric stem valve (Genebre system).

R	P	L	D
1/2"x3/8"	6	95	62
1/2"x1/2"	6	95	62

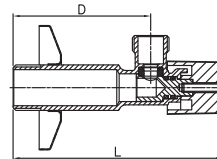

3294 04	1/2"x3/8"	90	2-200	2,83
3294 05	1/2"x1/2"	95	2-200	2,98

Precios a consultar / Prices on request

Ref. 3104



Válvula escuadra redonda "Tau"

Construcción de cuerpo y florón en latón según UNE-EN 12165 - cromado según EN-248. Extremos roscados gas (BSP) M-M según ISO 228/1. Apertura y cierre por montura cerámica.

Round angle valve "Tau"

Body and cover made in brass according to UNE-EN 12165. Chrome plated according to EN-248. Gas threaded ends (BSP) M-M ISO 228/1. Ceramic mount.

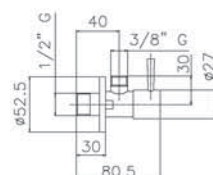

3104 04	1/2"x3/8"	150	2-120	8,20
3104 05	1/2"x1/2"	-	-	10,70

Ref. 3106



● **Válvula escuadra cuadrada "Cubik"**
 Construcción de cuerpo y florón en latón según UNE-EN 12165 - cromado según EN-248. Extremos roscados gas (BSP) M-M según ISO 228/1. Apertura y cierre por montura cerámica.

Square angle valve "Cubik"
 Body cover made in brass according to UNE-EN 12165. Chrome plated according to EN-248. Gas threaded ends (BSP) M-M ISO 228/1. Ceramic mount.

R x r	L	D
1/2"x3/8"	83	50

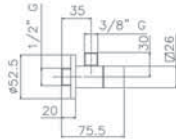

CÓDIGO CODE	MEDIDA SIZE	PESO WEIGHT	CAJA / BOX CARTON	P.V.P. € PRICE €
3106 04	1/2"x3/8"	220	2-120	10,88
3106 05	1/2"x1/2"	-	-	13,42

Ref. 3095



● **Válvula de escuadra con filtro**
 PN 10. Paso estándar. Construcción en latón según UNE-EN 12165 acabado cromado pulido. Extremos roscados macho según ISO 228/1. Temp. máx. 120°C. Filtro inox.

Angle valve with strainer
 PN 10. Standard bore. Chrome plated brass body UNE-EN 12165 - polished. Male threaded ends (BSP) DIN 228/1. Max. Temp. 120°C. Stainless steel strainer.

R	r	P	A	L
1/2"	3/8"	8	50	59
1/2"	1/2"	8	50	59
1/2"	3/4"	9	54	63

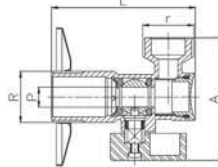

3095 03	1/2"x3/8"	91	10-240	3,43
3095 04	1/2"x1/2"	96	10-240	3,59
3095 05	1/2"x3/4"	113	10-240	4,30

Ref. 3095N



● **Válvula de escuadra con filtro - rosca NPT**
 PN 10. Paso estándar. Construcción en latón según UNE-EN 12165. Acabado cromado pulido. Extremos roscados macho según ANSI B 1.20.1 y UNEF 9/16 según ASME B 1.1. Temp. máx. 120°C. Filtro inox.

Angle valve with strainer - NPT thread
 PN 10. Standard bore. Brass construction according UNE-EN 12165. Polished chrome plated. Male thread ends NPT according ANSI B 1.20.1 and UNEF 9/16 according ASME B 1.1. Max. Temp. 120°C. Stainless steel strainer.

R	r	P	A	L
1/2"	UNEF 9/16 24H	8	50	59

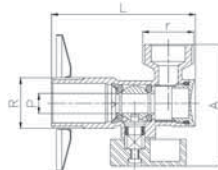

3095N 04	1/2"NPT x UNEF 9/16 24H	88	10-240	3,65
----------	-------------------------	----	--------	------

Ref. 3195N



● **Válvula de escuadra con filtro - rosca NPT**
 PN 10. Paso estándar. Construcción en latón según UNE-EN 12165. Acabado cromado pulido. Extremos roscados hembra NPT según ANSI B 1.20.1 y macho según ASME B 1.1 o según ISO 228/1. Temp. máx. 120°C. Filtro inox.

Angle valve with strainer - NPT thread
 PN 10. Standard bore. Brass construction according UNE-EN 12165. Polished chrome plated. Female NPT thread end according to ANSI B 1.20.1 and male according to ASME B 1.1 or according to ISO 228/1. Max. Temp. 120°C. Stainless steel strainer.

R	r	P	A	L
1/2" NPT	G3/8"	8	50	59
1/2" NPT	UNEF 9/16 24H	8	50	59

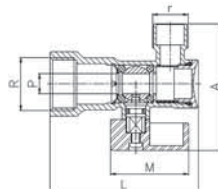

3195N 03	1/2"NPT x G3/8"	96	10-240	3,76
3195N 04	1/2"NPT x UNEF 9/16 24H	93	10-240	3,76

Ref. 3090



● **Válvula escuadra lavadora**

PN 10. Paso estándar. Construcción en latón según UNE-EN 12165 cromado. Juntas NBR. Extremos rosca gas (BSP) M-M ISO 228/1. Temp. máx. 120°C. Mando manual por palomilla ABS.

Washing machine angle valve

PN 10. Standard bore. Body brass UNE-EN 12165. NBR seats - M-M gas threaded ends (BSP) ISO 228/1. Max.Temp.160°C. ABS butterfly handle operated.

r	R	P	A	L	M
1/2"	3/4"	9	65	49	39

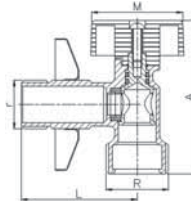

CÓDIGO CODE	MEDIDA SIZE	PESO WEIGHT	CAJA / BOX CARTON	P.V.P. € PRICE €
3090 04	1/2"x3/4"	120	10-180	4,22

Ref. 3091



● **Válvula esfera escuadra lavadora**

PN 16. Paso estándar. Construcción en latón según UNE-EN 12165 cromado. Asientos PTFE. Extremos rosca gas (BSP) M-M ISO 228/1. Temp. máx. 160°C. Mando manual por palomilla.

Washing machine angle valve

PN 16. Standard bore. Body brass UNE-EN 12165. PTFE seats - M-M gas threaded ends (BSP) ISO 228/1. Max. Temp. 160°C. Butterfly handle operated.

R	P	A	L	M
1/2"	9	65	49	38

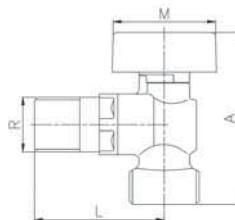

3091 04	1/2"x3/4"	155	10-180	5,10
---------	-----------	-----	--------	------

Ref. 3107 - 3108



● **Válvula mixta teleducha bide-WC dos salidas**

Disponible versión cromada (3107) y versión inoxidable (3108)

Bidet-WC mixed shower valve 2 outlets

Available in chromed (3107) and stainless steel finish (3108)

3107 03	1/2x1/2x3/8	-	1-160	6,11
3107 04	1/2x1/2x1/2	-	1-160	6,18
3108 03	1/2x1/2x3/8	-	1-160	6,13
3108 04	1/2x1/2x1/2	-	1-160	6,18

Ref. 3092



● **Válvula mixta lavadora – lavabo**

PN 16. Paso total. Construcción en latón según UNE-EN 12165. Acabado cromado pulido. Extremos roscados gas (BSP) según ISO 228/1 - accionamiento mediante volante. Temp. máx. 100°C.

Washing machine – washbasin mixed valve

PN 16. Full bore. Chrome plated brass body UNE-EN 12165 - polished. Gas threaded ends (BSP) ISO 228/1. Hand wheel operated. Max. Temp. 100°C.

R1	R2	r	A	L
1/2"	3/4"	3/8"	80,5	115

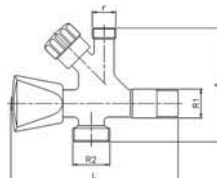

3092 04	1/2"	270	1-80	9,26
---------	------	-----	------	------

Ref. 3121 - 3121N



Válvula de retención "Re-Ge"

También disponible con rosca NPT (3121N)
PN 25/12. Construcción en latón UNE-EN 12165. Junta de clapeta vulcanizada de NBR. Muelle en acero inox. AISI 304. Extremos rosca gas (BSP) H-H - ISO 228/1. Temp. máx. 90°C. Montaje en cualquier posición.

Re-Ge check valve

Also available NPT thread (3121N)
PN 25/12. Body brass UNE-EN 12165. Vulcanized NBR gasket plate. Stainless steel spring AISI 304. Gas threaded ends (BSP) F-F ISO 228/1. Max. Temp. 90°C. Multipositional setting up.

R	PN	D	A
1/2"	25	30	50
3/4"	25	37	57
1"	25	43	65
1 1/4"	18	53	70
1 1/2"	18	65	76
2"	18	80	82
2 1/2"	12	104	104
3"	12	124	113
4"	12	155	132

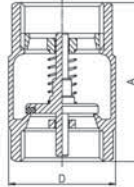

CÓDIGO CODE	MEDIDA SIZE	PESO WEIGHT	CAJA / BOX CARTON	P.V.P. € PRICE €
3121 04	1/2"	110	30-270	3,62
3121 05	3/4"	175	24-192	5,26
3121 06	1"	260	12-96	7,79
3121 07	1 1/4"	375	10-60	10,76
3121 08	1 1/2"	525	5-40	15,30
3121 09	2"	800	2-16	22,84
3121 10	2 1/2"	1555	1-15	50,84
3121 11	3"	2235	1-12	72,73
3121 12	4"	3665	1-5	115,71

Precios rosca NPT a consultar / NPT thread prices on request

Ref. 3122 - 3122N



Válvula de retención "Re-Ge plus"

También disponible con rosca NPT (3122N)
PN 25/12. Construcción en latón UNE-EN 12165 cromado. Cierre NBR vulcanizado. Muelle acero inox. AISI 304. Extremos rosca gas (BSP) H-H - ISO 228/1. Temp. máx. 90°C. Montaje vertical. Eje y guía de bronce para las medidas de 2 1/2" - 3" y 4".

"Re-Ge plus" check valve

Also available NPT thread (3122N)
PN 25/12. Body brass UNE-EN 12165. NBR vulcanized. Stainless steel spring AISI 304. Gas threaded ends (BSP) F-F ISO 228/1. Max. Temp. 90°C. Vertical setting up. Stem and guide made of bronze for sizes 2 1/2" - 3" and 4".

R	PN	D	A
1/2"	25	28	55
3/4"	25	35	63
1"	25	42	70
1 1/4"	18	52	76
1 1/2"	18	63	83
2"	18	78	90
2 1/2"	12	100	118
3"	12	121	128
4"	12	150	144

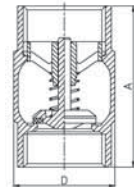

3122 04	1/2"	110	30-240	4,46
3122 05	3/4"	185	24-192	6,31
3122 06	1"	285	12-96	9,35
3122 07	1 1/4"	405	10-60	13,48
3122 08	1 1/2"	590	5-40	19,04
3122 09	2"	885	2-16	28,93
3122 10	2 1/2"	1900	1-15	65,81
3122 11	3"	2715	1-12	95,48
3122 12	4"	4480	1-5	157,31

Precios rosca NPT a consultar / NPT thread prices on request

Ref. 3141



Valvula de pie

PN-25/18 Paso total. Construcción en latón cromado UNE-EN 12165. Extremo roscado gas (BSP) H ISO 228/1. Temp. máx. 90°C. Cierre NBR vulcanizado. Muelle y tamiz inox. AISI 304. Presión mínima trabajo 0 - 03 bar.

Check valve with filter

PN 25/18. Body chrome plated brass UNE-EN 12165. Gas threaded end F ISO 228/1. Max. Temp. 90°C. Vulcanized NBR sealing. Stainless steel spring and sieve AISI 304. Minimum working pressure 0 - 03 bar.

R	PN	P	A	D
1/2"	25	15	78	28
3/4"	25	20	91	35
1"	25	25	97	42
1 1/4"	18	32	113	52
1 1/2"	18	40	128	63
2"	18	50	150	78

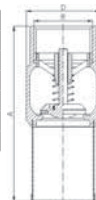

3141 04	1/2"	90	12-252	3,29
3141 05	3/4"	150	8-112	5,48
3141 06	1"	235	6-60	8,60
3141 07	1 1/4"	340	5-50	11,51
3141 08	1 1/2"	510	4-32	17,33
3141 09	2"	760	2-28	26,62

Disponible en 2 1/2", 3" y 4" consultar precios / Available in 2 1/2", 3" and 4" prices on request.

Ref. 3123



Válvula esfera con retención

PN-25. Paso total. Construcción en latón UNE-EN 12165 cromado. Asientos PTFE. Extremos roscados H-H ISO 228/1. Temp. máx. 90°C. Accionamiento esfera palomilla. Cierre retención NBR vulcanizado. Muelle acero inox AISI 304. Presión mínima trabajo 0 - 03 bar.

Ball valve with check valve

PN- 25. Full bore. Body chrome plated brass UNE-EN 12165. PTFE seats. Threaded ends F-F ISO 228/1. Max. Temp. 90°C. Ball working butterfly handle. Vulcanized NBR check valve sealing. Stainless steel spring AISI 304. Minimum working pressure 0 - 03 bar.

R	P	A	L	M
1/2"	15	76	50	50
3/4"	20	91	62	62
1"	25	106	69	62

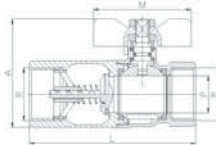

CÓDIGO CODE	MEDIDA SIZE	PESO WEIGHT	CAJA / BOX CARTON	P.V.P. € PRICE €
3123 04	1/2"	190	10-160	6,79
3123 05	3/4"	335	6-60	11,52
3123 06	1"	530	4-40	18,61

Ref. 3120



Válvula de retención "York"

PN 12/8. Construcción en latón UNE-EN 12165. Obturador de disco en poliamida 6. Cierre en NBR (goma) 65 sh. Muelle en acero inox. AISI 304. Extremos rosca gas (BSP) H-H - ISO 228/1. Temp. máx. 90°C. Montaje en cualquier posición.

"York" check valve

PN 12/8. Body brass UNE-EN 12165. NBR (rubber) seating 65 sh/ps. Stainless steel spring - AISI 304. Gas threaded ends (BSP) F-F ISO 228/1. Max. Temp. 90°C. Assembling: any position.

R	PN	P	B	A
3/8"	12	10	34	46
1/2"	12	15	34	47
3/4"	12	20	42	52
1"	12	25	48	60
1 1/4"	10	32	59	66
1 1/2"	10	40	70	73
2"	10	50	86	79
2 1/2"	8	65	102	97
3"	8	80	125	103
4"	8	100	153	119

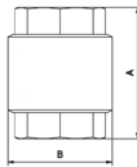

3120 03	3/8"	130	10-240	4,53
3120 04	1/2"	134	10-240	4,54
3120 05	3/4"	250	8-152	7,05
3120 06	1"	280	8-112	8,37
3120 07	1 1/4"	390	6-78	12,44
3120 08	1 1/2"	610	4-52	20,05
3120 09	2"	800	2-36	25,89
3120 10	2 1/2"	1450	1-24	51,50
3120 11	3"	2110	1-16	73,87
3120 12	4"	3290	1-11	128,13

Ref. 3131



Válvula de retención "Europa"

PN 25. Construcción en latón UNE-EN 12165. Cierre en NBR (goma) 65 sh. Muelle en acero inox. AISI 304. Extremos rosca gas (BSP) H-H - ISO 228/1. Temp. máx. 90°C. Montaje en cualquier posición.

"Europa" check valve

PN 25. Body brass UNE-EN 12165. NBR (rubber) seating 65 sh/ps. Stainless steel spring AISI 304. Gas threaded ends (BSP) F-F - ISO 228/1. Max. Temp. 90°C. Assembling: any position.

R	PN	P	B	A
3/8"	25	10	35	54
1/2"	25	15	35	57
3/4"	25	20	42	64
1"	25	25	48	75
1 1/4"	18	32	61	82
1 1/2"	18	40	71	93
2"	18	50	87	100
2 1/2"	12	65	120	120
3"	12	79	140	140
4"	12	100	173	158

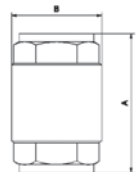

3131 03	3/8"	175	10-170	6,38
3131 04	1/2"	190	10-170	6,47
3131 05	3/4"	275	8-120	8,58
3131 06	1"	400	6-78	11,83
3131 07	1 1/4"	635	4-48	19,58
3131 08	1 1/2"	850	4-36	26,48
3131 09	2"	1300	2-24	40,47
3131 10	2 1/2"	2740	1-12	93,07
3131 11	3"	4000	1-8	140,86
3131 12	4"	6450	1-5	235,37

Ref. 3140



Válvula de pie "York"
 PN 10/6. Construcción en latón UNE-EN 12165. Cierre en NBR (goma) 65 sh. Muelle en acero inox. AISI 304. Extremo rosca gas (BSP) H - ISO 228/1. Temp. máx. 90°C.

"York" valve with filter
 PN 10/6. Body brass UNE-EN 12165. NBR (rubber) sealing 65 sh. Stainless steel spring AISI 304. Gas threaded end (BSP) F - ISO 228/1. Max. Temp. 90°C.

R	PN	P	B	A
3/8"	12	10	35	69,5
1/2"	12	15	35	70
3/4"	12	20	42	82
1"	12	25	48	91,5
1 1/4"	10	32	59,5	108
1 1/2"	10	40	70,5	119
2"	10	50	86	136,5
2 1/2"	6	65	103	164,5
3"	6	80	126	184,5
4"	6	100	154	214,5

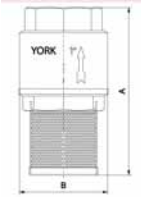

CÓDIGO CODE	MEDIDA SIZE	PESO WEIGHT	CAJA / BOX CARTON	P.V.P. € PRICE €
3140 03	3/8"	90	10-280	3,81
3140 04	1/2"	100	10-280	3,88
3140 05	3/4"	140	8-232	4,96
3140 06	1"	195	8-160	6,36
3140 07	1 1/4"	275	6-102	8,76
3140 08	1 1/2"	430	4-72	13,31
3140 09	2"	610	2-48	19,04
3140 10	2 1/2"	1065	1-30	35,89
3140 11	3"	1650	1-20	50,37
3140 12	4"	2475	1-10	85,96

Ref. 3160 - 3160N



Filtro válvula retención
 También disponible con rosca NPT (3160N)
 Tamiz acero inox - AISI 304. Racor nylon 6.6. Extremos rosca gas (BSP) M - ISO 228/1.

Stainless steel strainer for check valves
 Also available NPT thread (3160N)
 Stainless steel sieve AISI 304. Nylon 6.6. Gas threaded end (BSP) M - ISO 228/1.

R	Luz/ Light (microns)	D	A
3/8"	1000	49	23
1/2"	1000	51	27
3/4"	1000	57	34
1"	1000	58	40
1 1/4"	1000	69	48
1 1/2"	1000	81	58
2"	1000	96	68
2 1/2"	1200	96	83
3"	1200	116	100
4"	1200	132	127

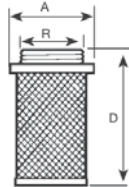

3160 03	3/8"	6	30-900	0,89
3160 04	1/2"	7	30-900	0,92
3160 05	3/4"	11	15-450	1,11
3160 06	1"	15	15-270	1,25
3160 07	1 1/4"	19	10-180	1,46
3160 08	1 1/2"	29	10-120	2,07
3160 09	2"	41	5-60	2,48
3160 10	2 1/2"	64	1-48	5,55
3160 11	3"	73	1-18	6,52
3160 12	4"	153	1-18	10,09

Precios rosca NPT a consultar / NPT thread prices on request

Ref. 3145 - 3145N



Válvula fondo
 También disponible con rosca NPT (3145N)
 PN 10/6. Construcción en latón UNE-EN 12165. Cierre en NBR 65 sh. Extremos rosca gas (BSP) H - ISO 228/1. Temp. máx. 90°C.

Bottom valve
 Also available NPT thread (3145N)
 PN 10/6. Body brass UNE-EN 12165. Rubber sealing guided seat. Gas threaded ends (BSP) F - ISO 228/1. Max. Temp. 90°C.

R	PN	P	B	A
3/4"	10	20	45,5	73
1"	10	25	52	81
1 1/4"	8	32	61,5	93,5
1 1/2"	8	40	68,5	102,5
2"	8	50	80	116,5
2 1/2"	6	65	103	136
3"	6	80	116,5	149,5
4"	6	100	145,5	187

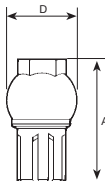

3145 05	3/4"	230	20-160	7,41
3145 06	1"	305	15-120	8,86
3145 07	1 1/4"	485	6-72	13,17
3145 08	1 1/2"	578	5-60	17,00
3145 09	2"	985	4-32	26,54
3145 10	2 1/2"	1375	1-24	40,71
3145 11	3"	1925	1-18	52,91
3145 12	4"	3335	1-8	97,68

Precios rosca NPT a consultar / NPT thread prices on request

Ref. 3180 - 3180N



Válvula de retención clapeta goma

También disponible con rosca NPT (3180N). PN 12/8. Construcción en latón UNE-EN 12165. Cierre NBR (goma) 65 sh. Extremos rosca gas (BSP) H-H - ISO 228/1. Temp. máx. 90°C. Montaje en horizontal.

Rubber swing check valve

Also available NPT thread (3180N). PN 12/8. Body brass UNE-EN 12165. Rubber sealing. Gas threaded ends (BSP) F-F - ISO 228/1. Max. Temp. 90°C. Horizontal assembling.

R	P	A	L	PN
1/2"	15	46,5	47	12
3/4"	20	54,5	52	12
1"	25	61,5	64,5	12
1 1/4"	30	72	74	10
1 1/2"	35	84	86	10
2"	45	94	97	10
2 1/2"	57	108	116,5	8
3"	60	130	137	8
4"	90	165	163	8

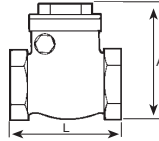

CÓDIGO CODE	MEDIDA SIZE	PESO WEIGHT	CAJA / BOX CARTON	P.V.P. € PRICE €
3180 04	1/2"	170	20-240	5,28
3180 05	3/4"	230	12-96	7,20
3180 06	1"	375	10-80	10,31
3180 07	1 1/4"	460	8-64	13,58
3180 08	1 1/2"	700	5-40	20,76
3180 09	2"	1060	3-30	28,61
3180 10	2 1/2"	1500	1-25	40,21
3180 11	3"	2410	1-16	65,05
3180 12	4"	3750	1-8	114,88

Precios rosca NPT a consultar / NPT thread prices on request

Ref. 3185 - 3185N



Válvula de retención clapeta metal

También disponible con rosca NPT (3185N). PN 12/8. Cierre metálico. Construcción en latón UNE-EN 12165. Extremos rosca gas (BSP) H-H - ISO 228/1. Temp. máx. 200°C. Montaje en horizontal.

Metal swing check valve

Also available NPT thread (3185N). PN 12/8. Metal sealing. Body brass UNE-EN 12165. Gas threaded ends (BSP) F-F - ISO 228/1. Max. Temp. 200°C. Horizontal assembling.

R	P	A	L	PN
1/2"	15	46,5	47	12
3/4"	20	54,5	52	12
1"	25	61,5	64,5	12
1 1/4"	30	72	74	10
1 1/2"	35	84,5	86	10
2"	45	94	97	10
2 1/2"	57	107	116,5	8
3"	60	130,5	137	8
4"	90	140,5	161	8

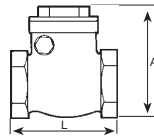

CÓDIGO CODE	MEDIDA SIZE	PESO WEIGHT	CAJA / BOX CARTON	P.V.P. € PRICE €
3185 04	1/2"	175	20-160	5,28
3185 05	3/4"	230	12-96	7,20
3185 06	1"	380	10-80	10,31
3185 07	1 1/4"	475	8-64	13,58
3185 08	1 1/2"	740	5-40	20,76
3185 09	2"	1045	3-30	28,61
3185 10	2 1/2"	1535	1-25	40,21
3185 11	3"	2400	1-16	65,05
3185 12	4"	3750	1-8	114,88

Precios rosca NPT a consultar / NPT thread prices on request

Ref. 3187



Válvula de retención cierre PTFE

PN 16. Cierre en PTFE. Construcción en bronce RG 5. Muelle en acero inox. Extremos rosca gas (BSP) H-H - ISO 228/1. Temp. máx. 180°C.

PTFE sealing check valve

PN 16. PTFE sealing. Body bronze RG5. Stainless steel spring AISI 316. Gas threaded ends (BSP) F - ISO 228/1. Max. Temp. 180°C.

R	L	A
3/8"	45	38
1/2"	50	39
3/4"	61	48
1"	71	53
1 1/4"	85	56
1 1/2"	90	63
2"	110	72

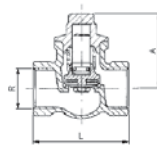

CÓDIGO CODE	MEDIDA SIZE	PESO WEIGHT	CAJA / BOX CARTON	P.V.P. € PRICE €
3187 03	3/8"	145	20-120	21,49
3187 04	1/2"	205	20-120	20,44
3187 05	3/4"	340	10-60	25,54
3187 06	1"	460	6-36	36,88
3187 07	1 1/4"	770	4-24	59,60
3187 08	1 1/2"	990	4-24	78,51
3187 09	2"	1640	2-12	110,35

Ref. 3190 - 3190N



Válvula seguridad de escape conducido

También disponible con rosca NPT (3190N) PN 16. Cierre PTFE. Construcción en latón UNE-EN 12165. Muelle en acero galvanizado. Regulación de: 0 - 5 a 16 bar. Extremos en escuadra rosca gas (BSP) H-H - ISO 228/1. Temp. -10°C +180°C.

Safety blow off valve

Also available NPT thread (3190N)

PN 16. PTFE sealing. Body brass UNE-EN 12165. Galvanized steel spring. Adjustable: from 0 - 5 to 16 bar. Gas threaded end (BSP) F-F - ISO 228/1. Working temperature: -10°C +180°C.

R	DN	L	L1	H
3/8"	10	45	24,5	115
1/2"	15	56	30	122
3/4"	20	64	32	149
1"	25	76	40	163
1 1/4"	32	90	44	192
1 1/2"	40	100	47	218
2"	50	124	60	247
2 1/2"	65	148	85	295
3"	80	157	88	330
4"	100	175	95	385

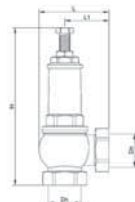

CÓDIGO CODE	MEDIDA SIZE	PESO WEIGHT	CAJA / BOX CARTON	P.V.P. € PRICE €
3190 03	3/8"	370	10-80	24,11
3190 04	1/2"	390	10-80	24,11
3190 05	3/4"	630	6-48	29,74
3190 06	1"	1000	4-32	39,66
3190 07	1 1/4"	1450	3-18	68,13
3190 08	1 1/2"	2100	2-12	81,62
3190 09	2"	3250	1-6	127,48
3190 10	2 1/2"	5500	1-4	337,64
3190 11	3"	6800	1-3	408,87
3190 12	4"	13300	1-1	673,52

Ref. 3193



Válvula de seguridad y retención
 PN 16. Construcción en latón UNE-EN 12165 cromado. Extremos rosca M-H - ISO 228/1. Muelles acero. Taraje estándar fijo a 8 bar. Cierre EPDM. Sistema antigoteo. Temp. máx. 120°C.

Safety check valve
 PN 16. Body chrome plated brass UNE-EN 12165. M-F threaded ends M-F - ISO 228/1. Steel springs. Standard tare 8 bar. EPDM sealing. Anti-drop system. Max. Temp. 120°C.

R	P	A	B
1/2"	10	40	48
3/4"	13	54	62

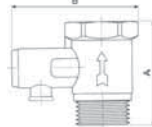

CÓDIGO CODE	MEDIDA SIZE	PESO WEIGHT	CAJA / BOX CARTON	P.V.P. € PRICE €
3193 04	1/2"	70	20-280	3,13
3193 05	3/4"	140	10-140	7,04

Ref. 3194



Válvula de seguridad y retención
 Mismas características que el art. 3193 más dispositivo descarga manual por palanca.

Safety check valve
 Same characteristics as art 3193 with manual unloading device by lever.

R	P	A	L
1/2"	10	46	65
3/4"	13	57	75

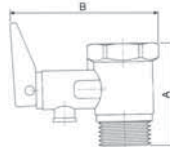

3194 04	1/2"	74	20-280	3,95
3194 05	3/4"	144	10-140	7,47

Ref. 3860



Manguito antielectrólisis
 PN 10. Construcción en poliamida 6 (nylon). Funda de cobre. Extremos rosca gas (BSP) H - H - ISO 228/1. Temp. máx. 90°C aire - 80°C agua.

Anti-electrolysis fitting
 PN 10. Body nylon. Copper cover. Gas threaded ends (BSP) F-F - ISO 228/1. Max. Temp. 90°C air - 80°C water.

R	P	A	L
1/2"	14	28	39
3/4"	20	35	38
1"	25	42	43
1 1/4"	32	54	58
1 1/2"	40	62	59
2"	50	80	75
2 1/2"	65	92	87
3"	80	105	96
4"	100	130	103

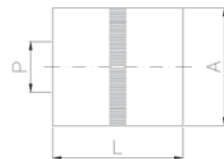

3860 04	1/2"	40	48-864	2,22
3860 05	3/4"	50	30-540	3,03
3860 06	1"	70	20-360	3,86
3860 07	1 1/4"	155	6-108	10,27
3860 08	1 1/2"	190	4-72	17,33
3860 09	2"	450	2-36	28,07
3860 10	2 1/2"	850	2-36	55,62
3860 11	3"	1030	1-18	64,34
3860 12	4"	1430	1-18	82,62

Ref. 3865



Manguito antielectrólisis
 PN 10. Construcción en poliamida 6 (nylon). Funda de cobre. Extremos rosca gas (BSP) M - H - ISO 228/1. Temp. máx. 90°C aire - 80°C agua.

Anti-electrolysis fitting
 PN 10. Body nylon. Copper cover. Gas threaded ends (BSP) M-F - ISO 228/1. Max. Temp. 90°C air - 80°C water.

R	P	A	L
1/2"	15	28	41
3/4"	19	35	42

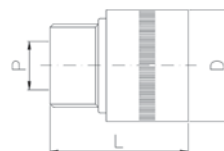

3865 04	1/2"	25	48-864	2,69
3865 05	3/4"	40	30-540	3,78

Ref. 3850

● Anticalcáreo magnético "Calcolit"
PN 10. Construcción en latón UNE-EN 12165 cromado.
Extremos rosca gas (BSP) M-M - ISO 228/1. Temp. máx. 120°C.



"Calcolit" magnetic limestone reducer
PN 10. Chrome plated brass UNE-EN 12165.
Gas threaded ends M-M - ISO 228/1. Max. Temp. 120°C.

R	A	B
1/2"	56	104
3/4"	56	106
1"	65	128
1 1/4"	79	141
1 1/2"	110	203
2"	110	203

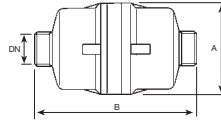

CÓDIGO CODE	MEDIDA SIZE	PESO WEIGHT	CAJA / BOX CARTON	P.V.P. € PRICE €
3850 04	1/2"	675	1-30	66,69
3850 05	3/4"	696	1-30	83,66
3850 06	1"	1140	1-25	100,67
3850 07	1 1/4"	1273	1-10	294,24
3850 08	1 1/2"	2239	1-10	380,29
3850 09	2"	2338	1-10	461,68

Ref. 3228

● Válvula de asiento de globo
PN 16. Tipo "Jenking". Construcción en bronce RG 5.
Extremos rosca gas (BSP) H-H - ISO 228/1. Prensa estopa universal.
Cierre PTFE. Temp. máx. 200°C.



Globe valve
PN 16. "Jenking" type. Body bronze RG5. Gas threaded ends (BSP) F-F - ISO 228/1. Packing nut. PTFE Sealing. Max. Temp. 200°C.

R	L	A	M
3/8"	45	67	50
1/2"	50	80	50
3/4"	62	85	50
1"	71	94	60
1 1/4"	85	106	70
1 1/2"	90	118	80
2"	110	127	80

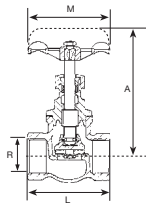

3228 03	3/8"	181	10-60	25,28
3228 04	1/2"	265	10-80	26,23
3228 05	3/4"	400	8-64	30,14
3228 06	1"	550	4-32	38,23
3228 07	1 1/4"	875	2-16	61,32
3228 08	1 1/2"	1135	2-16	82,99
3228 09	2"	1790	1-6	135,72

Ref. 3220 - 3222

● Válvula de compuerta latón
También disponible con rosca NPT (3222)
PN 10/16. Paso reducido. Construcción en latón UNE-EN 12165.
Prensa estopa: acrilonitrilo. Temp. máx. 120°C. Extremos rosca gas (BSP) H-H - ISO 228/1.



Brass gate valve
Also available NPT thread (3222)
PN 10/16. Reduce bore. Body brass UNE-EN 12165. Stuffing box - acrylonitril. Max. Temp. 120°C. Gas threaded ends (BSP) F-F - ISO 228/1.

R	PN	A	L	M
1/2"	10	62	39	45
3/4"	10	63	41	45
1"	10	75	48	50
1 1/4"	10	94	52	54
1 1/2"	10	100	52	59
2"	10	120	59	69
2 1/2"	16	155	60	99
3"	16	190	74	99
4"	16	230	85	119

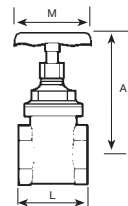

3220 04	1/2"	160	16-160	5,02
3220 05	3/4"	200	12-120	6,28
3220 06	1"	245	8-96	9,25
3220 07	1 1/4"	435	6-72	13,67
3220 08	1 1/2"	575	4-48	18,63
3220 09	2"	950	2-24	32,60
3220 10	2 1/2"	1755	1-12	55,53
3220 11	3"	2170	1-8	78,50
3220 12	4"	4165	1-4	142,40

Precios rosca NPT a consultar / NPT thread prices on request

Ref. 3221 - 3221N

● Válvula de compuerta latón
También disponible con rosca NPT (3221N) PN 20. Paso estándar.
Construcción en latón según UNE-EN 12165. Prensa estopa acrilonitrilo. Temp. máx. 180°C. Extremos rosca gas (BSP) H-H - ISO 228/1. Volante aluminio.



Brass gate valve
Also available NPT thread (3221N). PN 20. Standard bore. Brass construction UNE-EN 12165. Acrylonitril stuffing box. Max. Temp. 180°C. Gas threaded ends (BSP) F-F - ISO 228/1. Aluminium wheel.

R	P	A	H	L	C	M
1/2"	13	84	95	45,5	13,5	55
3/4"	18,5	95	110	50	13	60
1"	24	105	126	56	14,5	65
1 1/4"	30,5	122	150	61	16	75
1 1/2"	37	134	165	65	17	80
2"	45	153	190	74	20	90
2 1/2"	58	195	235	81	21	110
3"	67	210	265	84	21	120
4"	91	255	325	102	26	140

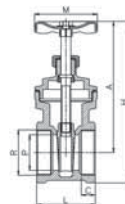

3221 04	1/2"	245	10-100	7,70
3221 05	3/4"	365	8-96	11,47
3221 06	1"	500	5-50	16,76
3221 07	1 1/4"	760	4-24	23,86
3221 08	1 1/2"	1020	2-24	31,43
3221 09	2"	1495	2-16	47,68
3221 10	2 1/2"	2300	1-6	76,71
3221 11	3"	3650	1-6	115,08
3221 12	4"	6000	1-4	212,58

Precios rosca NPT a consultar / NPT thread prices on request

Ref. 3230



Válvula de asiento inclinado
 PN 16. Paso total. Construcción en latón UNE-EN 12165. Prensa estopa: nitrilo. Temp. máx. 120°C. Extremos rosca gas (BSP) H-H - ISO 228/1.

Stanted seat valve
 PN 16. Full bore. Body brass UNE-EN 12165. Stuffing box - nitril sealing. Max. Temp. 120°C. Gas threaded ends (BSP) F-F - ISO 228/1.

R	P	A	L
1/2"	15	66	57
3/4"	20	70	66
1"	25	97	80
1 1/4"	32	115	92
1 1/2"	40	131	101
2"	50	155	121
2 1/2"	65	225	151
3"	78	232	172
4"	98	320	219

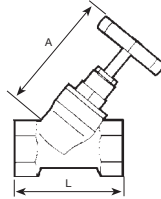

CÓDIGO CODE	MEDIDA SIZE	PESO WEIGHT	CAJA / BOX CARTON	P.V.P. € PRICE €
3230 04	1/2"	185	10-80	7,69
3230 05	3/4"	265	6-48	10,60
3230 06	1"	505	5-30	17,28
3230 07	1 1/4"	865	2-16	29,45
3230 08	1 1/2"	1025	1-8	37,00
3230 09	2"	1720	1-6	58,94
3230 10	2 1/2"	3450	1-5	158,03
3230 11	3"	4900	1-4	217,13
3230 12	4"	9900	1-2	382,18

Ref. 3236



Válvula de compuerta para transformadores
 Const.: Bronce. Extremos bridados PN 16. Con indicador de posición y dispositivo de bloqueo. Máxima presión de trabajo 16 bar. Temperatura de trabajo -10°C +170°C.

Gate valve for transformers
 Const. Bronze. Flanged ends PN 16. With position indicator and locking device. Maximum working pressure 16 bar. Working temperature -10°C +170°C.

DN	A	B	C
15	95	76	117
25	115	76	147
32	140	90	165
40	150	120	185
50	165	135	217
80	200	185	280

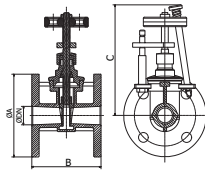

NOVEDAD
NEW

3236 04	1/2"	1500	-	198,29
3236 06	1"	2875	-	264,00
3236 07	1 1/4"	4300	-	349,40
3236 08	1 1/2"	5000	-	453,03
3236 09	2"	7000	-	640,72
3236 11	3"	12000	-	1.461,40

Ref. 3069



Válvula con filtro colador tipo "Y"
 PN 16. Construcción en latón UNE-EN 12165. Extremos rosca gas (BSP) hembra. ISO 228/1. Tamiz: inox AISI 304. Luz: 400 micras. Temp. máx. 180°C.

Brass valve with type "Y" strainer filter
 PN 16. Body chrome plated brass UNE-EN 12165. Gas threaded ends (BSP) F-F - ISO 228/1. Sieve: stainless steel AISI 304. Light: 400 microns. Max. Temp. 180°C.

R	A	L	M
1/2"	66	78	52
3/4"	83	92	60
1"	98	112	68

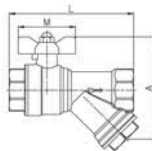

3069 04	1/2"	245	6-108	7,05
3069 05	3/4"	400	4-72	11,58
3069 06	1"	580	2-36	16,72

Ref. 3302 - 3302N



Filtro colador tipo "Y" latón
 También disponible con rosca NPT (3302N)
 PN 16. Cuerpo latón UNE-EN 12165. Tamiz: inox. AISI 304. Junta tapa: NBR. Temp. máx. 120°C. Extremos rosca gas (BSP) H-H - ISO 228/1.

"Y" brass strainer
 Also available NPT thread (3302N)
 PN 16. Body brass UNE-EN 12165. Sieve: stainless steel AISI 304. NBR joint. Max. Temp. 120°C. Gas threaded ends (BSP) F-F - ISO 228/1.

R	H	L	Luz/ Light (microns)
1/2"	38	56,5	500
3/4"	44	66	500
1"	50	74	500
1 1/4"	66	96	500
1 1/2"	71	104	500
2"	89	125	500
2 1/2"	110	154	1200
3"	120	173	1200
4"	152	210	1200

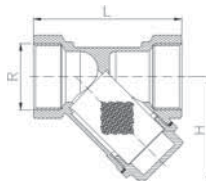

3302 04	1/2"	115	24-192	3,55
3302 05	3/4"	195	12-96	5,41
3302 06	1"	265	10-80	7,98
3302 07	1 1/4"	540	5-60	16,11
3302 08	1 1/2"	610	2-36	21,34
3302 09	2"	1150	1-18	35,36
3302 10	2 1/2"	2100	1-15	67,69
3302 11	3"	2900	1-10	93,33
3302 12	4"	5500	1-4	176,62

Precios rosca NPT a consultar / NPT thread prices on request

Ref. 3304



Filtro colador tipo "Y" bronce
 Construcción en bronce según UNE-EN 1982. Tamiz: inox. AISI 304.
 Temperatura de trabajo de -20°C a 110°C.
 Extremos rosca gas (BSP) H - H - ISO 228/1.

Bronze "Y" type strainer filter
 Body bronze UNE-EN 1982. Sieve: stainless steel AISI 304.
 Working temperature from -20°C to 110°C.
 Gas threaded ends (BSP) F-F - ISO 228/1.

R	PN (bar)	DN	H	L	Luz / Light (microns)
3/8"	16	12	40	55	400
1/2"	16	15	44	59	400
3/4"	16	20	50,5	69	400
1"	16	25	60	82	400
1 1/4"	16	32	73	98,5	500
1 1/2"	16	40	80	109	500
2"	16	50	98	131	500
2 1/2"	10	65	114	151	500
3"	10	78	130	172	500
4"	10	98	170	219	500

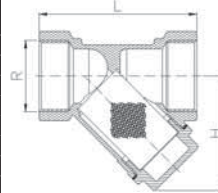

CÓDIGO CODE	MEDIDA SIZE	PESO WEIGHT	CAJA / BOX CARTON	P.V.P. € PRICE €
3304 03	3/8"	180	25-100	8,37
3304 04	1/2"	220	20-120	9,52
3304 05	3/4"	300	12-72	15,10
3304 06	1"	440	10-60	20,72
3304 07	1 1/4"	700	5-30	31,14
3304 08	1 1/2"	860	1-25	39,02
3304 09	2"	1620	1-15	65,15
3304 10	2 1/2"	2200	1-10	101,17
3304 11	3"	3440	1-6	142,12
3304 12	4"	7700	1-3	299,32

Ref. 3310



Filtro polivalente para agua
 PN 16. Construcción en latón UNE-EN 12165 cromado.
 Extremos rosca gas (BSP) H-H - ISO 228/1. Tamiz: acero inox.
 AISI 304. Luz: 800 micras. Junta tórica NBR. Temp. máx. 120°C.

In-line strainer for water
 PN 16. Body chrome plated brass UNE-EN 12165.
 Gas threaded ends (BSP) F-F - ISO 228/1. Sieve: stainless steel
 AISI 304. Light: 800 microns. NBR o-ring. Max. Temp. 120°C.

R	D	L	M	A
1/2"	27	58	36	62
3/4"	33	74	43	76
1"	40	90	48	87
1 1/4"	49	115	56	105
1 1/2"	58	135	66	115
2"	71	161	80	135

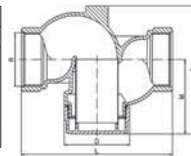

3310 04	1/2"	140	10-160	4,96
3310 05	3/4"	240	8-80	8,17
3310 06	1"	375	6-54	12,63
3310 07	1 1/4"	660	5-30	23,61
3310 08	1 1/2"	980	2-12	34,73
3310 09	2"	1535	1-8	55,08

Ref. 3311



Filtro polivalente para gasoil
 PN 16. Cuerpo latón UNE-EN 12165 cromado. Extremos rosca gas
 (BSP) H-H - ISO 228/1. Tamiz: acero inox. AISI 304. Luz: 300 micras.
 Junta tórica NBR. Temp. máx. 120°C.

In-line strainer for diesel oil
 PN 16. Body chrome plated brass UNE-EN 12165. Gas threaded ends
 (BSP) F-F - ISO 228/1. Sieve: stainless steel AISI 304.
 Light: 300 microns. NBR o-ring. Max. Temp. 120°C.

R	D	L	M	A
1/2"	27	58	36	62
3/4"	33	74	43	76
1"	40	90	48	87
1 1/4"	49	115	56	105
1 1/2"	58	135	66	115
2"	71	161	80	135

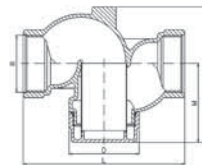

3311 04	1/2"	140	10-140	5,07
3311 05	3/4"	240	8-80	8,33
3311 06	1"	375	6-60	12,83
3311 07	1 1/4"	660	5-30	24,29
3311 08	1 1/2"	985	2-12	36,08
3311 09	2"	1540	1-8	56,57

Ref. 3312



Filtro polivalente para gas
 PN 16. Cuerpo latón UNE-EN 12165 cromado. Extremos rosca gas
 (BSP) H-H - ISO 228/1. Tamiz: acero inox. AISI 304. Luz: 50 micras.
 Junta tórica NBR. Temp. máx. 120°C.

In-line strainer for gas
 PN 16. Body chrome plated brass UNE-EN 12165. Gas threaded ends
 (BSP) F-F - ISO 228/1. Sieve: stainless steel AISI 304.
 Light: 50 microns. NBR o-ring. Max. Temp. 120°C.

R	D	L	M	A
1/2"	27	58	36	62
3/4"	33	74	43	76
1"	40	90	48	87
1 1/4"	49	115	56	105
1 1/2"	58	135	66	115
2"	71	161	80	135

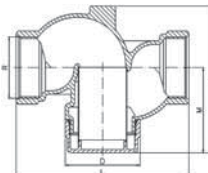

3312 04	1/2"	140	10-160	5,25
3312 05	3/4"	240	8-80	8,85
3312 06	1"	375	6-60	12,83
3312 07	1 1/4"	665	5-30	24,70
3312 08	1 1/2"	990	2-12	36,68
3312 09	2"	1545	1-8	57,48

Ref. 3313



Filtro autolimpiante

PN 16. Construcción en latón UNE-EN 12165 cromado. Tamiz: acero inox. AISI 304. Luz: 500 micras. Junta NBR. Extremos rosca gas (BSP) H-H - ISO 228/1. Temp. máx. 120°C.

Self-cleaning filter

PN 16. Chrome plated brass construction UNE-EN 12165. Sieve: Stainless steel AISI 304. Light: 500 microns. NBR O-ring. Gas threaded ends (BSP) M-M - ISO 228/1. Max. Temp. 120°C.

R	A	L	M
1/2"	189	58	49
3/4"	197	74	56
1"	208	90	61

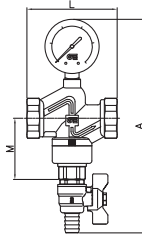

CÓDIGO CODE	MEDIDA SIZE	PESO WEIGHT	CAJA / BOX CARTON	P.V.P. € PRICE €
3313 04	1/2"	335	1	19,50
3313 05	3/4"	425	1	23,83
3313 06	1"	560	1	30,55

Ref. 3314



Filtro autolimpiante largo

PN 16. Construcción en latón UNE-EN 12165 cromado. Tamiz reforzado: acero inox. AISI 304. Luz: 500 micras. Junta NBR. Extremos rosca gas (BSP) H-H - ISO 228/1. Temp. máx. 120°C.

Long self-cleaning filter

PN 16. Chrome plated brass construction UNE-EN 12165. Reinforced sieve: Stainless steel AISI 304. Light: 500 microns. NBR O-ring. Gas threaded ends (BSP) M-M - ISO 228/1. Max. Temp. 120°C.

R	A	L	M
1/2"	212	58	78
3/4"	226	74	84
1"	239	90	92
1 1/4"	265	115	102
1 1/2"	278	135	116
2"	303	161	134

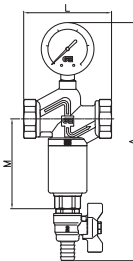

3314 04	1/2"	380	1-50	23,01
3314 05	3/4"	485	1-24	28,32
3314 06	1"	650	1-24	36,39
3314 07	1 1/4"	1015	1-18	53,02
3314 08	1 1/2"	1435	1-10	74,19
3314 09	2"	2105	1-6	108,70

Ref. 3315



Filtro magnético multifunción

Con válvulas de esfera H-H (ISO 228/1) y desviador en latón - porta filtro en polímero. Cartucho filtrante AISI 304. Máx. presión 3 bar. Max. Temperatura 90°C.

Multifunction magnetic filter

Brass metal diverter and valves F-F valves (ISO 228/1) - Plastic polymer cartridge holder body. S.S AISI 304 filtering cartridge. Max. pressure 3 bar. Max. temperature 90°C.

R	A	B
3/4"	153	277
1"	153	293

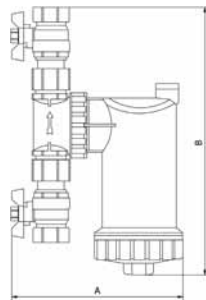

3315 05	3/4"	1235	1	177,78
3315 06	1"	1270	1	198,15

Ref. 3316



NOVEDAD
NEW

Filtro autolimpiante
PN 16. Construcción en latón niquelado.
Tamiz: acero inox. AISI 304. Luz: 100 micras.
Extremos rosca gas (BSP) M-M - ISO 228/1.
Con dos manómetros y válvula de vaciado
Max. Temperatura 100°C.

Self-cleaning filter
PN 16. Nickel plated brass construction.
Sieve: Stainless steel AISI 304. Light: 100 micron.
Gas thread ends (BSP) M-M - ISO 228/1.
With double pressure gauge and discharge valve.
Max. temperature 100°C.

R	A	B
1/2"	257	145
3/4"	257	155
1"	267	164

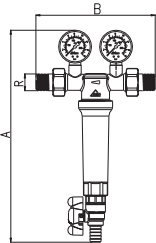

CÓDIGO CODE	MEDIDA SIZE	PESO WEIGHT	CAJA / BOX CARTON	P.V.P. € PRICE €
3316 04	1/2"	940	1	195,63
3316 05	3/4"	1110	1	216,56
3316 06	1"	1585	1	284,19

Ref. 3318



Válvula reductora de presión Redux-Ge a pistón
También disponible con rosca NPT (3318N)
PN 25. Construcción en latón UNE-EN 12165 cromado. Cierre
acero inox. AISI 303. Muelle en acero zincado EN-10270. Juntas
EPDM perox. Extremos rosca gas (BSP) H-H - ISO 228/1. Temp. máx.
trabajo 130°C. Presión entrada máxima 25 bar.

Redux-GE piston pressure reducer valve
Also available NPT thread (3318N).
PN 25. Chrome plated brass construction UNE-EN 12165. AISI 303
stainless steel sealing. Zinc plated steel spring EN-10270. EPDM
perox joints. Gas threaded ends (BSP) F-F - ISO 228/1. Max. working
temp. 130°C. Max. Inlet pressure 25 bar.

R	A	ØB	C	L	Presión salida/ Output pressure	
					Min.	Max.
1/2"	114,5	48	63,5	69,5	0,5	5,5
3/4"	114,5	48	63,5	82	0,5	5,5
1"	146	59	73,5	96	0,5	5,5
1-1/4"	152	59	73,5	100	0,5	6
1-1/2"	148,5	59	77	97	0,5	6
2"	150,5	59	81	97	0,5	6
2-1/2"	263,5	76	112	147	1	7
3"	285	82,5	112	179	1	7
4"	325	88,5	124	189	1	7

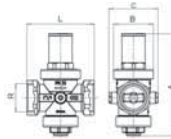

3318 04	1/2"	565	1- 40	19,62
3318 05	3/4"	590	1- 40	22,75
3318 06	1"	1015	1- 20	37,21
3318 07	1 1/4"	1160	1-20	58,38
3318 08	1 1/2"	1325	1-20	72,71
3318 09	2"	1500	1-20	84,22
3318 10	2 1/2"	3990	1- 6	254,63
3318 11	3"	5500	1-3	351,75
3318 12	4"	6850	1- 2	802,08
3318N 04	1/2"	565	1- 40	21,58
3318N 05	3/4"	590	1- 40	24,64
3318N 06	1"	1015	1- 20	39,36
3318N 07	1 1/4"	1160	1-20	61,30
3318N 08	1 1/2"	1325	1-20	76,35
3318N 09	2"	1500	1-20	88,43
3318N 10	2 1/2"	3990	1- 6	267,36
3318N 11	3"	5500	1-3	369,34
3318N 12	4"	6850	1- 2	842,18

Ref. 3322



Válvula reductora de presión a pistón con filtro
PN 15. Construcción en latón UNE-EN 12165 y Nylon 6 + 30% FV.
Juntas NBR. Filtro AISI 302 800 micras. Extremos rosca gas (BSP)
H-H - ISO 228/1. Temp. máx. trabajo 80°C. Presión entrada máxima
15 bar.

Redux-GE piston pressure reducer valve with filter
PN 15. Brass construction UNE-EN 12165 and Nylon 6 + 30% GF.
NBR joints. AISI 302 filter 800 microns. Gas threaded ends (BSP) F-F
- ISO 228/1. Max. working temp. 80°C. Max. Inlet pressure 15 bar.

R	A	B	C	ØD	Presión salida/ Output pressure	
					Min.	Max.
1/2"	75	17	73	46	0,5	6
3/4"	78	16	74	46	0,5	6
1"	103	25	106	61	0,5	7
1-1/4"	115	31	110	61	0,5	7



3322 04	1/2"	-	1	35,06
3322 05	3/4"	-	1	38,85
3322 06	1"	-	1	86,86
3322 07	1 1/4"	-	1	107,59

Precios a consultar / Prices on request

Ref. 3324



Válvula reductora de presión a pistón con filtro
 PN 15. Construcción en latón UNE-EN 12165 y Nylon 6 + 30% FV. Juntas NBR. Filtro AISI 302 800 micras. Extremos rosca gas (BSP) H-H - ISO 228/1. Temp. máx. trabajo 80°C. Presión entrada máxima 15 bar. Mando visualización presión de ajuste.

Redux-GE piston pressure reducer valve with filter
 PN 15. Brass construction UNE-EN 12165 and Nylon 6 + 30% GF. NBR joints. AISI 302 filter 800 microns. Gas threaded ends (BSP) F-F - ISO 228/1. Max. working temp. 80°C. Max. Inlet pressure 15 bar. Setting pressure visual control.

R	A	B	C	ØD	Presión salida/ Output pressure	
					Min.	Max.
1/2"	75	17	73	46	0,5	5
3/4"	78	16	74	46	0,5	5



CÓDIGO CODE	MEDIDA SIZE	PESO WEIGHT	CAJA / BOX CARTON	P.V.P. € PRICE €
3324 04	1/2"	-	1	35,06
3324 05	3/4"	-	1	38,85

Precios a consultar / Prices on request

Ref. 3320



Válvula reductora de presión "Rinodox" a pistón
 PN 16. Cuerpo latón UNE-EN 12165 cromado. Cierre inox AISI 304. Muelle en acero al silicio zincado. Juntas tóricas: NBR. Presión entrada máxima 15 bar. Extremos rosca gas (BSP) H-H - ISO 228/1.

"Rinodox" piston pressure reducer valve
 PN 16. Body chrome plated brass UNE-EN 12165. Sealing inox AISI 304. Zinc plated silicone steel spring. O'ring NBR. Max. Input pressure 15 bar. Gas threaded ends (BSP) F-F - ISO 228/1.

R	A	L	P	Presión Salida (bar)/ Output Pressure (bar)	
				Min	Máx.
1/2"	108	60	69	0,5	4
3/4"	108	60	69	0,5	4
1"	149	86	92	0,5	7
1 1/4"	160	91	96	0,5	7
1 1/2"	160	91	102	0,5	7
2"	160	91	102	0,5	7

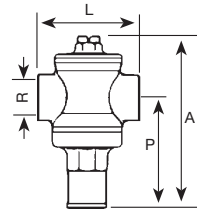

3320 04	1/2"	550	1-40	22,99
3320 05	3/4"	550	1-40	24,52
3320 06	1"	1100	1-20	57,69
3320 07	1 1/4"	1340	1-25	85,13
3320 08	1 1/2"	1410	1-25	118,41
3320 09	2"	1520	1-25	148,35

Ref. 3340



Válvula reductora de presión "Rinnox" a membrana
 PN 16/25. Caudal total. Cuerpo latón UNE-EN 12165 cromado. Cierre acero inox AISI 304. Muelle en acero al silicio zincado. Membrana y juntas tóricas: NBR. Presión entrada máx. 25 bar. Extremos rosca gas (BSP) H-H - ISO 228/1.

"Rinnox" membrane pressure reducer valve
 PN 16/25. Full flow. Body chrome plated brass UNE-EN 12165. Sealing inox AISI 304. Zinc plated silicone steel spring o-ring NBR. Membrane: reinforced EPDM. Max. input pressure 25 bar. Gas threaded ends (BSP) F-F - ISO 228/1.

R	A	L	P	PN	Presión Salida (bar)/ Output Pressure (bar)	
					Min	Máx.
1/2"	135	76,5	83	16	0,8	5,5
3/4"	135	76,5	83	16	0,8	5,5
1"	198	95	135	25	0,8	5,5
1 1/4"	220	116	153	25	0,8	7
1 1/2"	235	122	163	25	0,8	7
2"	235	126	163	25	0,8	7
2 1/2"	390	180	290	25	0,8	7
3"	390	188	290	25	0,8	7
4"	390	202	290	25	0,8	7

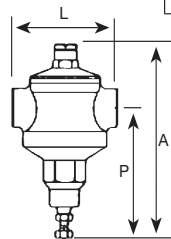

3340 04	1/2"	990	1-12	51,78
3340 05	3/4"	990	1-20	57,40
3340 06	1"	1600	1-25	89,85
3340 07	1 1/4"	2340	1-13	136,77
3340 08	1 1/2"	3000	1-10	199,38
3340 09	2"	3200	1-10	271,23
3340 10	2 1/2"	12900	1-1	835,20
3340 11	3"	13100	1-1	1.073,35
3340 12	4"	14000	1-1	1.616,89

Ref. 3344



NOVEDAD
NEW

● **Válvula reductora de presión a pistón con bridas**
Bridas DIN PN 10/16 . Cuerpo aleación de bronce UNI EN 1982. Cierre inox. AISI 303. Juntas tóricas: NBR. Máxima presión de entrada 30 bar. Max. Temperatura de trabajo 80°C. Rango de salida ajustable de 1 - 5 a 7 - 5 bar.

*Direct acting piston flanged ends pressure reducing valve
Flanged DIN PN 10/16. Bronze alloy body UNI EN 1982. Sealing inox. AISI 303. O'rings NBR. Maximum inlet pressure 30 bar. Maximum working temperature 80°C. Outlet range: adjustable from 1 to 7 - 5 bar.*

DN	L	H
50	147	250
65	164	260



CÓDIGO CODE	MEDIDA SIZE	PESO WEIGHT	CAJA / BOX CARTON	P.V.P. € PRICE €
3344 09	2"	10500	1	847,52
3344 10	2 1/2"	10700	1	972,65

Ref. 3910



● **Brida roscada macho PN 16**
DIN 2566. Construcción en latón UNE-EN 12165. Extremo rosca macho BSP ISO 228. Principal aplicación para filtros autolimpiantes y reductoras de presión.

*Male threaded flange PN 16
DIN 2566. Brass construction UNE-EN 12165. Threaded male end ISO 228. Use mainly for self-cleaning filters and pressure reducing valves.*

R	DN	d	d1	d2	h
1 1/2"	40	150	110	18	56
2"	50	165	125	18	58
2 1/2"	65	185	145	18	60
3"	80	200	160	18	64
4"	100	220	180	18	74

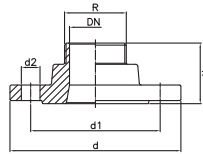

3910 08	1 1/2"	2300	1	79,01
3910 09	2"	2850	1	113,75
3910 10	2 1/2"	4150	1	160,33
3910 11	3"	5050	1	205,33
3910 12	4"	5550	1	243,03

Ref. 3910i

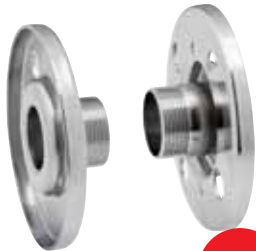

NOVEDAD
NEW

● **Brida roscada PN 16**
Construcción en acero inox. AISI 316. Extremo rosca M (ISO 228). Aplicación para filtros autolimpiantes y reductoras de presión.

*Threaded flange PN 16
Stainless steel AISI 316 construction. Thread end M (ISO 228).
Use mainly for self-cleaning filters and pressure reducing valves.*

R	A	C	H	D	S	Nº agujeros/ Nº Holes
2 1/2"	185	145	60	17	4	4
3"	200	160	70	19	4	8
4"	225	180	80	19	5	8

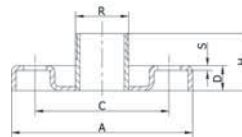

3910i 10	2 1/2"	1200	1	64,27
3910i 11	3"	1450	1	79,11
3910i 12	4"	2177	1	98,77

Ref. 3772 - 3773



● **Racor 5 vías acoplamiento bombas**
PN 16. Construcción latón UNE-EN 12165. Extremos roscados gas (BSP) M y H - ISO 7/1. Temperatura máxima trabajo 180°C.

*5 ways fitting for pump connection
PN 16. Brass construction UNE-EN 12165.
Gas threaded ends (BSP) M & H - ISO 7/1.
Max. working temperature 180°C.*

Ref.	A	B	C	D
3772	48	33	29	24
3773	67	33	29	24

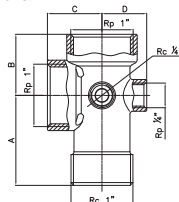

3772 06 06	1" - 81 mm	205	12-144	8,00
3773 06 06	1" - 100 mm	235	8-96	9,33

Ref. 3780



Presostato para agua
Para controlar presión de bombas de agua. Tensión de conexión 230V 50Hz. Potencia máxima conexión 1,5 KW. Presión máxima trabajo 4 bar. Regulación de 0 a 4 bar. Tiempo máximo de maniobras 60 ciclos/min. Diferencial variable.

Pressure switch for water
To control pressure of water pumps. Connection voltage 230V 50Hz. Max. connection power 1.5 KW. Max. working pressure 4 bar. Scale from 0 to 4 bar. Max. operating time 60 cycles/min. Variable differential.

CÓDIGO CODE	MEDIDA SIZE	PESO WEIGHT	CAJA / BOX CARTON	P.V.P. € PRICE €
3780 02	1/4"	356	1-64	6,90

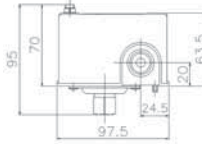

Ref. 3781



Presostato para agua
Para controlar presión de bombas de agua. Tensión de conexión 230V 50Hz. Potencia máxima conexión 1,5 KW. Presión máxima trabajo 10 bar. Regulación de 4 a 10 bar. Tiempo máximo de maniobras 60 ciclos/min. Diferencial variable.

Pressure switch for water
To control pressure of water pumps. Connection voltage 230V-50Hz. Max. connection power 1.5 KW. Max. working pressure 10 bar. Scale from 4 to 10 bar. Max. operating time 60 cycles/min. Variable differential.

3781 02	1/4"	318	1-64	9,33
---------	------	-----	------	------

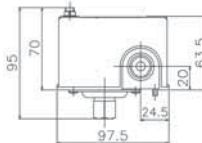

Ref. 3784



Presostato 1 vía para aire
Para controlar presión de compresores. Tensión de conexión 240V 50Hz. Potencia máxima conexión 2,2 KW. Presión máxima trabajo 12 bar. Regulación de 1,5 a 12 bar. Diferencial variable. Rosca 1/4" NPT. Válvula de descarga incorporada. Función desconexión manual.

1 way pressure switch for air
To control pressure of air pumps. Connection voltage 240V-50Hz. Max. connection power 2.2 KW. Max. working pressure 12 bar. Scale from 1.5 to 12 bar. Variable differential. NPT 1/4" thread. Discharge valve incorporated. Manual disconnection function.

3784 02	1/4" NPT	368	1-60	15,69
---------	----------	-----	------	-------

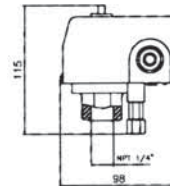

Ref. 3785



Presostato 4 vías para aire
Para controlar presión de compresores. Tensión de conexión 240V 50Hz. Potencia máxima conexión 2,2 KW. Presión máxima trabajo 12 bar. Regulación de 1,5 a 12 bar. Diferencial variable. Rosca 1/4" NPT. Válvula de descarga incorporada. Función desconexión manual.

4 ways pressure switch for air
To control pressure of air pumps. Connection voltage 240V-50Hz. Max. connection power 2.2 KW. Max. working pressure 12 bar. Scale from 1.5 to 12 bar. Variable differential. NPT 1/4" thread. Discharge valve incorporated. Manual disconnection function.

3785 02	1/4" NPT	349	1-60	16,21
---------	----------	-----	------	-------

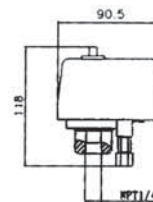

Ref. 3880

Interruptor de nivel vertical

Tensión de conexión 220V-50Hz. Potencia máxima de conexión 1,5KW. Temp. máx. ambiente 80°C. Protección IP68.



Vertical level switch

Connection voltage 220V- 50Hz. Max. connection power 1.5 KW. Max. ambient temp. 80°C. Protection IP68.

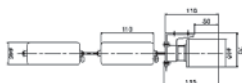

CÓDIGO CODE	MEDIDA SIZE	PESO WEIGHT	CAJA / BOX CARTON	P.V.P. € PRICE €
3880 00	-	159	1-24	10,72

Ref. 3881

Interruptor de nivel horizontal

Tensión de conexión 220V-50Hz. Potencia máxima de conexión 1,5KW. Temp. máx. funcionamiento 50°C. Protección IP68.

040 con longitud de cable 40 cm.
300 con longitud de cable 300 cm.



Horizontal level switch

Connection voltage 220V-50Hz. Max. connection power 1.5 KW. Max. operating temp. 50°C. Protection IP68.

040 with 40 cm. cable.
300 with 300 cm. cable.

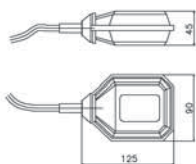

3881 040	-	194	1-24	10,30
3881 300	-	200	1-24	12,49

Ref. 3882

Contrapeso

Montable en el interruptor de nivel horizontal para la regulación de niveles. Temperatura máxima 50°C. Apto para cables hasta ø10 mm.



Counterweight

Assembling in the horizontal level switch - to regulate levels. Max. operating temp. 50°C suitable for cables until ø10 mm.

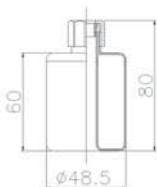

3882 00	-	249	1-100	1,85
---------	---	-----	-------	------

Ref. 3883

Interruptor de nivel horizontal conmutable

Tensión de conexión 220V-50Hz. Potencia máxima de conexión 1,5KW. Temp. máx. funcionamiento 50°C. Protección IP68. 300 con longitud de cable 300 cm. 500 con longitud de cable 500 cm.



Commutable horizontal level switch

Assembling in the horizontal level switch - to regulate levels. Voltage 220V-50Hz. Max. connection power 1.5 KW. Max. operating temp. 50°C. Protection IP68. 300 with 300 cm. cable. 500 with 500 cm. cable.

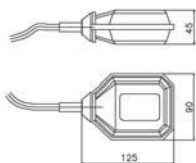

3883 300	-	194	1-22	15,43
3883 500	-	200	1-20	19,25

Ref. 3886

● **Válvula de flotador sin boya**

Construcción en acero inoxidable AISI 304. Conexión Rosca Gas.

Paso total. Cierre de silicona. Presión de trabajo máxima 10 Kg/cm².

Floating valve without bouy

Made of Stainless Steel AISI 304. Conexion Gas Threaded. Full Port. Silicone Lock. Max. Working pressure 10 Kg/cm².

MED.	L	A
3/8"	300	32
1/2"	410	35
3/4"	500	42
1"	580	45
1 1/4"	580	52



CÓDIGO CODE	MEDIDA SIZE	PESO WEIGHT	CAJA / BOX CARTON	P.V.P. € PRICE €
3886 03	3/8"	100	10	15,30
3886 04	1/2"	180	10	16,47
3886 05	3/4"	300	10	28,26
3886 06	1"	370	5	30,42
3886 07	1 1/4"	460	5	35,12

Ref. 3887

● **Boya para flotador**

Construcción en acero inoxidable AISI 304.

Bouy for floating valves

Made of stainless steel AISI 304.

MED.	D	M
3/8"	90	M-6
1/2"	100	M-6
3/4"	160	M-8
1"	160	M-8
1 1/4"	160	M-8

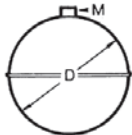

3887 090	Ø 90 mm	070	1	11,93
3887 110	Ø 110 mm	100	1	14,91
3887 160	Ø 160 mm	290	1	32,42

Ref. 2848

● **Controlador de flujo (líquidos)**

Caja aleación aluminio galvanizado. Racor latón. Lengüetas en acero inox. Para tuberías de 1" a 8". Conexión rosca gas 1". Temp. máx. 110°C. Presión máx. 10 bar. 220V - 10A. Protección IP-64.

Liquid flow switch

Galvanized aluminium alloyed box. Brass connector. Blade: stainless steel for pipe from 1" to 8". Thread gas connection 1". Max. Temp. 110°C. Max. pressure 10 bar. 220V - 10A. protection IP-64.

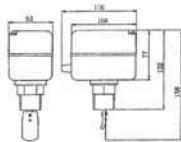

2848 06	1"	800	1-10	53,87
---------	----	-----	------	-------

Ref. 2850

● **Controlador de flujo (líquidos)**

Caja acero pintado - racor latón. Lengüetas en acero inox. Para tuberías de 1" a 8". Conexión rosca gas 1". Temp. máx. 110°C. Presión máx. 10bar. 220V - 10A. Protección IP-54.

Liquid flow switch

Coated steel box. Brass connector. Blade: stainless steel for pipe from 1" to 8". Threaded gas connection 1". Max. Temp. 110°C. Max. Pressure 10 bar. 220V - 10A. Protection: IP 54.

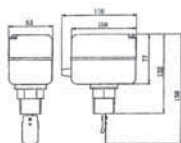

2850 06	1"	800	1-10	49,59
---------	----	-----	------	-------

Ref. 3250



NOVEDAD
NEW

Controlador automático de bombas de agua

Para activar/desactivar el funcionamiento de una bomba en instalaciones y suministros. Tensión de conexión 240V 50Hz. Intensidad máx. 30(16)A. Presión de arranque/ paro de bomba ajustable entre 1 bar - 2,2 bar. Max. Potencia 3 CV. Presión de trabajo 10 bar. Max. temp. trabajo 60°C. Protección IP 65.

Automatic water pump control

To power on/off pump operation for installations and supply. Connection voltage 240V 50Hz. Max. Current 30(16)A. Start/ stop pressure adjustable 1 bar - 2.2 bar. Horse power 3 Hp. Max. working pressure 10 bar. Max. working temp. 60°C. IP 65.

CÓDIGO CODE	MEDIDA SIZE	PESO WEIGHT	CAJA / BOX CARTON	P.V.P. € PRICE €
3250 01	1 1/4" 1,5 BAR	1485	1-16	151,11
3250 02	1 1/4" 2,2 BAR	1485	1-16	155,56

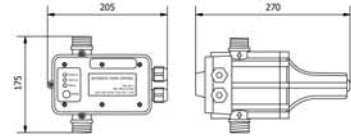

Ref. 3251



Controlador automático de bombas de agua

Para activar/ desactivar el funcionamiento de una bomba en instalaciones y suministros. Tensión de conexión 230V 50Hz. Intensidad máx. 8A. Presión de arranque/ paro de bomba ajustable entre 1bar - 3 bar. Potencia 1,5 CV. Max presión de trabajo 10 bar. Max. temp. trabajo 55°C. Protección IP 65.

Automatic water pump control

To power on/off pump operation for installations and supply. Connection voltage 230V 50Hz. Max. current 8A. Start/ stop pressure adjustable 1 bar -3 bar. Horse power 1,5 Hp. Max. working pressure 10 bar. Max. working temp. 55°C. IP 65.

3251	1"x1"	824	1-16	62,10
------	-------	-----	------	-------

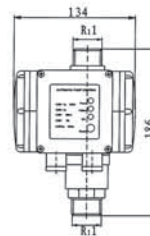

Ref. 3253



Controlador automático de bombas de agua

Para activar/desactivar el funcionamiento de una bomba en instalaciones y suministros. Tensión de conexión 230V 50Hz. Intensidad máx. 6A. Presión de arranque / paro de bomba 1,5 bar. Potencia 1,5 CV. Max presión de trabajo 10 bar. Max. temp. trabajo 60°C. Protección IP 65. Manómetro 0-10 bar incorporado.

Automatic water pump control

To power on/off pump operation for installations and supply. Connection voltage 230V 50Hz. Max. current 6A. Start/ stop pressure 1.5 bar. Horse power 1,5 Hp. Max. working pressure 10 bar. Max. working temp. 60°C. IP 65. Pressure gauge 0-10 bar incorporated.

3253	1"x1"	1138	1-16	53,17
------	-------	------	------	-------

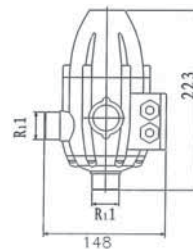

Ref. 3254



NOVEDAD
NEW

Controlador automático de bombas de agua

Para activar/desactivar el funcionamiento de una bomba en instalaciones y suministros. Tensión de conexión 220V-240V 50/60 Hz. Intensidad máx. 10A. Presión de arranque / paro de bomba 1,5 bar. Potencia 1,5 CV. Máx. presión de trabajo 10 bar. Máx. temp. Trabajo 60°C. Protección IP 65.

Automatic water pump control

To power on/off pump operation for installations and supply. Connection voltage 220V-240V 50/60 Hz. Max. current 10A. Start / Stop pressure 1.5 bar. Horse power 1,5 Hp. Max. working pressure 10 bar. Max. working temp. 60°C. IP 65.

3254	1" x 1"	1120	1-12	53,17
------	---------	------	------	-------

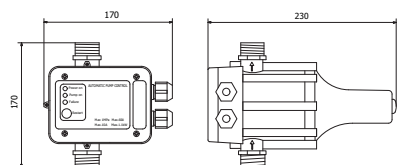

Ref. 3264



NOVEDAD
NEW

Controlador automático de bombas de agua

Para activar/desactivar el funcionamiento de una bomba en instalaciones y suministros. Tensión de conexión 110V-120V 50/60 Hz. Intensidad máx. 10A. Presión de arranque / paro de bomba 1,5 bar. Potencia 1 CV. Máx. presión de trabajo 10 bar. Máx. temp. Trabajo 60°C. Protección IP 65.

Automatic water pump control

To power on/off pump operation for installations and supply. Connection voltage 110V-120V 50/60 Hz. Max. current 10A. Start / Stop pressure 1.5 bar. Horse power 1 Hp. Max. working pressure 10 bar. Max. working temp. 60°C. IP 65.

CÓDIGO CODE	MEDIDA SIZE	PESO WEIGHT	CAJA / BOX CARTON	P.V.P. € PRICE €
3264	1" x 1"	1120	1-12	54,77

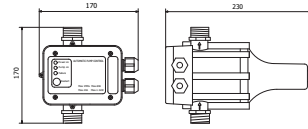

Ref. 3265



NOVEDAD
NEW

Controlador automático de bombas de agua (multi-bombas)

Para activar/desactivar el funcionamiento de dos conjuntos de bombas monofásicas en instalaciones y suministros. Tensión de conexión 220 - 240V 50/60 Hz. Intensidad máx. 10A. Presión de arranque / paro de bomba ajustable entre 1,5 bar - 3 bar. Potencia 1,5 CV. Máx. presión de trabajo 10 bar. Máx. temp. Trabajo 50°C. Protección IP54.

Automatic water pump control (multiple-pump set)

To power on/off two sets of single-phase pumps operation for installations and supply. Connection voltage 220 -240V 50/60 Hz. Max. current 10A. Start / Stop pressure adjustable 1.5 bar - 3 bar. Horse power 1,5 Hp. Max. working pressure 10 bar. Max. working temp. 50°C. IP 54.

3265	1 1/4" x 1 1/4"	1510	1	311,67
------	-----------------	------	---	--------

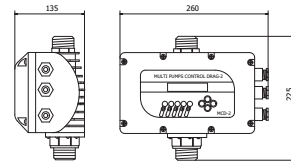

Ref. 3884



Controlador de volumen de aire

Construcción en acero al carbono zincado Q235 resistente al choque térmico. Membrana en polipropileno. Extremos roscados NPT 3/8" x 7/16"-24. Para volúmenes de depósitos de 45 y 100 galones. Max temp. trabajo 60°C. Max. presión trabajo 150 psi (10 bar).

Air volume control

Zinc plated carbon steel Q235A shock therm resistant construction. Polypropylene membrane. Threaded ends NPT 3/8" x 7/16" 24. Available for tanks volume of 45 and 100 gallons. Max.working temp. 60°C. Max.working pressure: 150 psi (10 bar).

ØD	H
104	92

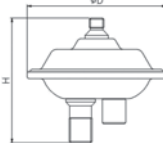

3884 00	NPT 3/8" x 7/16"-24"	165	1-48	8,18
---------	----------------------	-----	------	------

Ref. 3884



NOVEDAD
NEW

Controlador de volumen de aire

Construcción en aleación de zinc (Zamac). Membrana en EPDM. Conexiones roscadas hembra NPT 1/4" x NPT 3/8". Para volúmenes de depósitos de 120 galones. Max temp. trabajo 60°C. Max. presión trabajo 150 psi.

Air volume control

Zinc alloy (Zamac) construction. EPDM membrane. Female threaded connections NPT 1/4" x NPT 3/8". Available for tanks volume of 120 gallons. Available for tanks volume of 120 gallons. Max.working temp. 60°C. Max.working pressure: 150 psi.

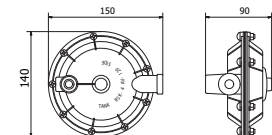

3884 120	NPT 1/4" x NPT 3/8"	860	1-20	36,19
----------	---------------------	-----	------	-------

Ref. 3819



Manómetro Ø53 indicador rojo, salida inferior
Caja ABS. Tubo bourdon y racor latón UNE-EN 12165. Rosca 1/4" macho gas (BSP). Graduaciones disponibles 0 a 2,5-4-6-10-16-25 bar. Salida inferior (radial). Clase de precisión 2,5.

Pressure gauge Ø53, red index, bottom connection
ABS case. Brass bourdon pipe and connector UNE-EN 12165. 1/4" male gas threaded (BSP). Scale available from 0-2.5-4-6-10-16-25 bar. Bottom connection (radial). Precision class 2.5.

A	L	D
46	53	27

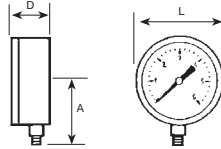

CÓDIGO CODE	bar	psi	PESO WEIGHT	CAJA / BOX CARTON	P.V.P. € PRICE €
3819 002	0-2,5	0-40	67	1-280	4,64
3819 004	0-4	0-60	67	1-280	4,64
3819 006	0-6	0-90	67	1-160	4,64
3819 010	0-10	0-150	67	1-160	4,64
3819 016	0-16	0-240	67	1-280	4,64
3819 025	0-25	0-400	67	1-280	4,64

Ref. 3818



Manómetro Ø53 indicador rojo, salida posterior
Caja ABS. Tubo bourdon y racor latón UNE-EN 12165. Rosca 1/4" macho gas (BSP). Graduaciones disponibles 0 a 2,5-4-6-10-16-25 bar. Salida posterior. Clase de precisión 2,5.

Pressure gauge Ø53, red index, back connection
ABS case. Brass bourdon pipe and connector UNE-EN 12165. 1/4" male gas threaded (BSP). Scale available from 0-2.5-4-6-10-16-25 bar. Back connection. Precision class 2.5.

A	L	D
48	53	27

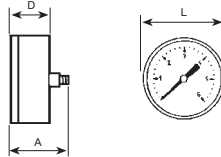

3818 002	0-2,5	0-40	67	1-140	4,83
3818 004	0-4	0-60	67	1-140	4,83
3818 006	0-6	0-90	67	1-210	4,83
3818 010	0-10	0-150	67	1-210	4,83
3818 016	0-16	0-240	67	1-210	4,83
3818 025	0-25	0-400	67	1-140	4,83

Ref. 3820



Manómetro Ø53, salida inferior, rosca BSP
Caja ABS. Tubo bourdon y racor latón UNE-EN 12165. Rosca 1/4" macho gas (BSP). Graduaciones disponibles 0 a 2,5-4-6-10-16-25 bar. Salida inferior (radial). Clase de precisión 2,5.

Pressure gauge Ø53, bottom connection, BSP thread
ABS case. Brass bourdon pipe and connector UNE-EN 12165. 1/4" male gas threaded (BSP). Scale available from 0-2.5-4-6-10-16-25 bar. Bottom connection (radial). Precision class 2.5.

A	L	D
47	53	27

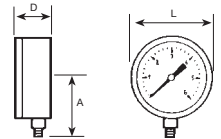

3820 002	0-2,5	0-40	68	1-280	4,33
3820 004	0-4	0-60	68	1-280	4,35
3820 006	0-6	0-90	68	1-280	4,35
3820 010	0-10	0-150	68	1-280	4,35
3820 016	0-16	0-240	68	1-280	4,35
3820 025	0-25	0-400	68	1-280	4,35

Ref. 3820N



Manómetro Ø53, salida inferior, rosca NPT
Caja ABS. Tubo bourdon y racor latón UNE-EN 12165. Rosca 1/4" macho gas (NPT). Graduaciones disponibles 0 a 2,5-4-6-10-16-25 bar. Salida inferior (radial). Clase de precisión 2,5.

Pressure gauge Ø53, bottom connection, NPT thread
ABS case. Brass bourdon pipe and connector UNE-EN 12165. 1/4" male gas threaded (NPT). Scale available from 0-2.5-4-6-10-16-25 bar. Bottom connection (radial). Precision class 2.5.

A	L	D
47	53	27

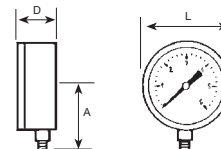

3820N 002	0-2,5	0-40	68	1-160	4,46
3820N 004	0-4	0-60	68	1-160	4,46
3820N 006	0-6	0-90	68	1-280	4,46
3820N 010	0-10	0-150	68	1-280	4,46
3820N 016	0-16	0-240	68	1-160	4,46
3820N 025	0-25	0-400	68	1-280	4,46

Ref. 3821



Manómetro Ø53, salida posterior, rosca BSP
Caja ABS. Tubo bourdon y racor latón UNE-EN 12165. Rosca 1/4" macho gas (BSP). Graduaciones disponibles 0 a 2,5-4-6-10-16-25 bar. Salida posterior. Clase de precisión 2,5.

Pressure gauge Ø53, back connection, BSP thread
ABS case. Brass bourdon pipe and connector UNE-EN 12165. 1/4" male gas threaded (BSP). Scale available from 0-2,5-4-6-10-16-25 bar. Back connection. Precision class 2.5.

A	L	D
48	53	27

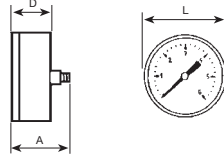

CÓDIGO CODE	bar	psi	PESO WEIGHT	CAJA / BOX CARTON	P.V.P. € PRICE €
3821 002	0-2,5	0-40	72	1-210	4,53
3821 004	0-4	0-60	72	1-210	4,55
3821 006	0-6	0-90	72	1-210	4,55
3821 010	0-10	0-150	72	1-210	4,55
3821 016	0-16	0-240	72	1-210	4,55
3821 025	0-25	0-400	72	1-210	4,55

Ref. 3825



Manómetro Ø63, indicador rojo, salida inferior
Caja ABS. Tubo bourdon y racor latón UNE-EN 12165. Rosca 1/4" macho gas (BSP). Graduaciones disponibles 0 a 2,5-4-6-10-16-25 bar. Salida inferior (radial). Clase de precisión 2,5.

Pressure gauge Ø63, red index, bottom connection
ABS case. Brass bourdon pipe and connector UNE-EN 12165. 1/4" male gas threaded (BSP). Scale available from 0-2,5-4-6-10-16-25 bar. Bottom connection (radial). Precision class 2.5.

A	L	D
50	63	28

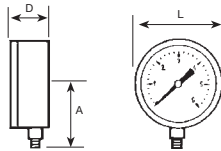

3825 002	0-2,5	0-40	75	1-180	4,75
3825 004	0-4	0-60	75	1-180	4,75
3825 006	0-6	0-90	75	1-180	4,75
3825 010	0-10	0-150	75	1-180	4,75
3825 016	0-16	0-240	75	1-180	4,75
3825 025	0-25	0-400	75	1-180	4,75

Ref. 3826



Manómetro Ø63, indicador rojo, salida posterior
Caja ABS. Tubo bourdon y racor latón UNE-EN 12165. Rosca 1/4" macho gas (BSP). Graduaciones disponibles 0 a 2,5-4-6-10-16-25 bar. Salida posterior. Clase de precisión 2,5.

Pressure gauge Ø63, red index, back connection
ABS case. Brass bourdon pipe and connector UNE-EN 12165. 1/4" male gas threaded (BSP). Scale available from 0-2,5-4-6-10-16-25 bar. Back connection (radial). Precision class 2.5.

A	L	D
49	63	29

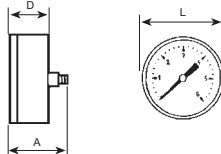

3826 002	0-2,5	0-40	75	1-75	4,97
3826 004	0-4	0-60	75	1-75	4,97
3826 006	0-6	0-90	75	1-75	4,97
3826 010	0-10	0-150	75	1-132	4,97
3826 016	0-16	0-240	75	1-75	4,97
3826 025	0-25	0-400	75	1-75	4,97

Ref. 3822



Manómetro Ø63 con glicerina, salida inferior, rosca BSP
Caja acero inox. AISI 304. Tubo bourdon y racor latón UNE-EN 12165. Rosca 1/4" macho gas (BSP). Graduaciones disponibles 0 a 2,5-4-6-10-16-25-60-100 bar. Salida inferior (radial). Clase de precisión 2,5.

Pressure gauge Ø63 with glycerine, bottom connection, BSP thread
Stainless steel AISI 304 case. Brass bourdon pipe and connector UNE-EN 12165. 1/4" male gas threaded (BSP). Scale available from 0-2,5-4-6-10-16-25-60-100 bar. Bottom connection (radial). Precision class 2.5.

A	L	D
55	63	30

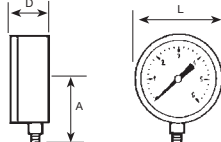

3822 002	0-2,5	0-40	175	1-160	11,00
3822 004	0-4	0-60	175	1-160	11,22
3822 006	0-6	0-90	175	1-160	11,22
3822 010	0-10	0-150	175	1-160	11,22
3822 016	0-16	0-240	175	1-160	11,22
3822 025	0-25	0-400	175	1-160	11,22
3822 060	0-60	0-900	175	1-160	11,22
3822 100	0-100	0-1500	175	1-160	11,22

Ref. 3822N



● **Manómetro Ø63 con glicerina, salida inferior, rosca NPT**
Caja acero inox. AISI 304. Tubo bourdon y racor latón UNE-EN 12165. Rosca 1/4" macho gas (NPT). Graduaciones disponibles 0 a 2,5-4-6-10-16-25-60-100 bar. Salida inferior (radial). Clase de precisión 2,5.

Pressure gauge Ø63 with glycerine, bottom connection, NPT thread
Stainless steel AISI 304 case. Brass bourdon pipe and connector UNE-EN 12165. 1/4" male gas threaded (NPT). Scale available from 0-2.5-4-6-10-16-25-60-100 bar Bottom connection (radial). Precision class 2.5.

A	L	D
55	63	30

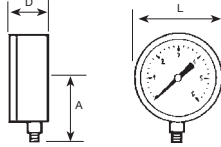

CÓDIGO CODE	bar	psi	PESO WEIGHT	CAJA / BOX CARTON	P.V.P. € PRICE €
3822N 002	0-2,5	0-40	175	1-160	11,57
3822N 004	0-4	0-60	175	1-160	11,57
3822N 006	0-6	0-90	175	1-160	11,57
3822N 010	0-10	0-150	175	1-160	11,57
3822N 016	0-16	0-240	175	1-160	11,57
3822N 025	0-25	0-400	175	1-160	11,57
3822N 060	0-60	0-900	175	1-100	11,57
3822N 100	0-100	0-1500	175	1-100	11,57

Ref. 3829



● **Manómetro Ø63 con glicerina, salida posterior, rosca BSP**
Caja acero inox. AISI 304. Tubo bourdon y racor latón UNE-EN 12165. Rosca 1/4" macho gas (BSP). Graduaciones disponibles 0 a 2,5-4-6-10-16-25-60-100 bar. Salida posterior. Clase de precisión 2,5.

Pressure gauge Ø63 with glycerine, back connection, BSP thread
Stainless steel AISI 304 case. Brass bourdon pipe and connector UNE-EN 12165. 1/4" male gas threaded (BSP). Scale available from 0-2.5-4-6-10-16-25-60-100 bar. Back connection. Precision class 2.5.

A	L	D
48	63	27

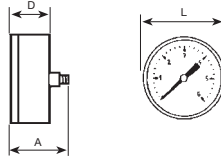

3829 002	0-2,5	0-40	175	1-160	11,57
3829 004	0-4	0-60	175	1-160	11,57
3829 006	0-6	0-90	175	1-160	11,57
3829 010	0-10	0-150	175	1-160	11,57
3829 016	0-16	0-240	175	1-160	11,57
3829 025	0-25	0-400	175	1-160	11,57
3829 060	0-60	0-900	175	1-160	11,57
3829 100	0-100	0-1500	175	1-160	11,57

Ref. 3814



● **Manómetro Ø63 con glicerina, salida inferior, rosca BSP**
Caja acero inox AISI 304. Tubo bourdon y racor en acero inox. AISI 304. Rosca 1/4" macho gas (BSP). Graduaciones disponibles 0 a 2,5-4-6-10-16-25-40- 60-100 bar. Salida inferior (radial). Clase de precisión 2,5.

Pressure gauge Ø63 with glycerine, bottom connection, BSP thread
Stainless steel AISI 304 case - bourdon pipe and connector. 1/4" male gas threaded (BSP). Scale available from 0-2.5-4-6-10-16-25-40-60-100 bar. Bottom connection (radial). Precision class 2.5.

A	L	D
56	63	30

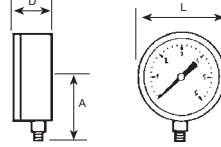

3814 002	0-2,5	0-40	175	1-160	24,80
3814 004	0-4	0-60	175	1-160	24,80
3814 006	0-6	0-90	175	1-160	24,80
3814 010	0-10	0-150	175	1-160	24,80
3814 016	0-16	0-240	175	1-160	24,80
3814 025	0-25	0-400	175	1-160	24,80
3814 040	0-40	0-600	175	1-160	24,80
3814 060	0-60	0-900	175	1-160	24,80
3814 100	0-100	0-1500	175	1-160	24,80

Ref. 3714



● **Manómetro Ø63 mm, salida inferior, rosca NPT**
Caja acero al carbono. Tubo bourdon y racor latón UNE-EN 12165. Rosca macho 1/4" NPT. Salida inferior (radial). Clase de precisión 2,5. Escala de medición Kg/cm², psi.

Pressure gauge Ø63 mm, bottom connection, NPT thread
Carbon steel case. Brass bourdon pipe and connector UNE-EN 12165. 1/4" male NPT threaded. Bottom connection (radial). Precision class 2.5. Kg/cm², psi scale.

A	L	D
51	63	30

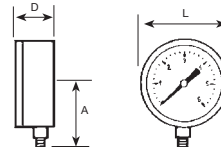

3714 004	0-4	0-60	115	1-160	4,97
3714 007	0-7	0-100	115	1-160	4,97
3714 010	0-10	0-150	115	1-200	4,97
3714 014	0-14	0-200	115	1-160	4,97
3714 017	0-17	0-250	115	1-160	4,97
3714 021	0-21	0-300	115	1-160	4,97
3714 028	0-28	0-400	115	1-160	4,97
3714 016	0-16	-	115	1-160	-
3714 315	0-315	-	115	1-160	-

3714 016 - Especial Oxígeno
3714 315 - Especial acetileno (no usar aceite)

3714 016 - Special for oxygen
3714 315 - Special for Acetylene (not oil)

Ref. 3827



● **Manómetro Ø80 mm, indicador rojo, salida inferior, rosca BSP**
Caja ABS, índice rojo, doble escala. Tubo Bourdon y racor en latón UNE-EN 12165. rosca 3/8" macho gas (BSP). Graduaciones disponibles 0 a 2,5-4-6-10-16-25-40 bar. Salida inferior. Clase de precisión 2,5.

Pressure gauge Ø80 mm, red index, bottom connection, BSP thread
ABS Case, red index, double scale. Bourdon pipe and connector 3/8" male gas threaded (BSP). Scale available from 0-2.5-4-6-10-16-25-40 bar. Bottom connection (radial). Precision class 2.5

A	L	D
70	80	32

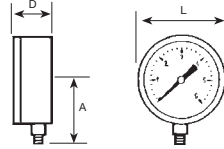

CÓDIGO CODE	bar	psi	PESO WEIGHT	CAJA / BOX CARTON	P.V.P. € PRICE €
3827 002	0-2,5	0-40	148	1-60	6,86
3827 004	0-4	0-60	148	1-75	6,86
3827 006	0-6	0-90	148	1-75	6,86
3827 010	0-10	0-150	148	1-75	6,86
3827 016	0-16	0-240	148	1-75	6,86
3827 025	0-25	0-400	148	1-75	6,86
3827 040	0-40	0-600	148	1-75	6,86

Ref. 3824



● **Manómetro Ø100 con glicerina, salida inferior, rosca BSP**
Caja acero inox AISI 304, tubo bourdon y racor en acero inox. AISI 304. Rosca 1/2" macho gas (BSP). Graduaciones disponibles 0 a 2,5-4-6-10-16-25-40-60-100 bar. Salida inferior (radial). Clase de precisión 1,6.

Pressure gauge Ø100 with glycerine, bottom connection, BSP thread
Stainless steel AISI 304 case, bourdon pipe and connector. 1/2" male gas threaded (BSP). Scale available from 0-2.5-4-6-10-16-25-40-60-100 bar. Bottom connection (radial). Precision class 1.6.

A	L	D
85	100	36

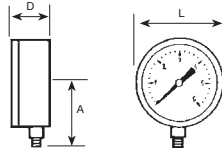

3824 002	0-2,5	0-40	520	1-44	39,52
3824 004	0-4	0-60	520	1-44	39,52
3824 006	0-6	0-90	520	1-44	39,52
3824 010	0-10	0-150	520	1-44	39,52
3824 016	0-16	0-240	520	1-44	39,52
3824 025	0-25	0-400	520	1-44	39,52
3824 040	0-40	0-600	520	1-44	39,52
3824 060	0-60	0-900	520	1-44	39,52
3824 100	0-100	0-1500	520	1-44	39,52

Ref. 3824N



● **Manómetro Ø100 con glicerina, salida inferior, rosca NPT**
Caja acero inox AISI 304, tubo Bourdon y racor en acero inox. AISI 304. Rosca 1/2" macho (NPT). Graduaciones disponibles 0 a 4-6-10-16-25-40 bar. Salida inferior (radial). Clase de precisión 1,6.

Pressure gauge Ø100 with glycerine, bottom connection, NPT thread
Stainless steel AISI 304 case, Bourdon pipe and connector. 1/2" male threaded (NPT). Scale available from 0-4-6-10-16-25-40-60-100 bar. Bottom connection (radial). Precision class 1.6.

A	L	D
85	100	36

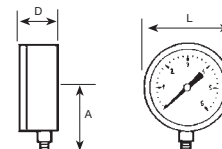

3824N 002	0-2,5	0-40	520	1-44	41,50
3824N 004	0-4	0-60	520	1-44	41,50
3824N 006	0-6	0-90	520	1-30	41,50
3824N 010	0-10	0-150	520	1-44	41,50
3824N 016	0-16	0-240	520	1-30	41,50
3824N 025	0-25	0-400	520	1-44	41,50
3824N 040	0-40	0-600	520	1-44	41,50
3824N 060	0-60	0-900	520	1-44	41,50
3824N 100	0-100	0-1500	520	1-44	41,50

Ref. 3950 - 3952 - 3955



(3950) Cinta "PTFE"

12 m. de longitud - 0 - 075 mm. de espesor - 12 mm. de ancho - 0 - 35 g/cm³ de densidad.

(3950) "PTFE" tape

12 m. length - 0 - 075 mm. thickness - 12 mm. width - 0 - 35 g/cm³ density.

(3952) Cinta "PTFE"

12 m. de longitud - 0 - 060 mm. de espesor - 12 mm. de ancho - 0 - 26 g/cm³ de densidad.

(3952) "PTFE" tape

12 m. length - 0 - 060 mm. thickness - 12 mm. width - 0 - 26 g/cm³ density.

(3955) Cinta "PTFE"

50 m. de longitud - 0 - 1 mm. de espesor - 19 mm. de ancho - 0 - 54 g/cm³ de densidad.

(3955) "PTFE" tape

50 m. length - 0 - 1 mm. thickness - 19 mm. width - 0 - 54 g/cm³ density.

CÓDIGO CODE	MEDIDA SIZE	PESO WEIGHT	CAJA / BOX CARTON	P.V.P. € PRICE €
3950 00	0,075x12	11	100-1000	0,47

3952 00	0,060x12	10	100-1000	0,34
---------	----------	----	----------	------

3955 00	0,1x19	73	25-200	5,26
---------	--------	----	--------	------

Ref. 3956



PTFE líquido 50 ml.

Adhesivo anaeróbico para sellar conexiones roscadas metálicas. Resistente a golpes y vibraciones. Temperaturas desde -55°C a +150°C. Fácil desmontaje de piezas selladas.

Liquid "PTFE" 50 ml

Anaerobic adhesive for sealing metal thread pipe joints. Shocks and vibrations resistant. Temperatures from -55°C to +150°C. Easy dismantling of sealed joints.

3956 00	50 ml.	20	10-50	11,63
---------	--------	----	-------	-------

SERVICIOS DE AGUA

El sistema GE-Block patentado por Genebre, diseñado para nuestra gama de válvulas antifraude, permite mediante una llave especial, bloquear la válvula en posición de apertura, cierre y 10% del caudal nominal.

Dirigido a empresas proveedoras de las compañías de distribución de agua de cada país.

CARACTERÍSTICAS DE LAS VÁLVULAS

- Construcción en latón UNE-EN 12164-12165
- Extremos roscados ISO 228/1
- Extremos conexión tubería PE baja, media y alta densidad
- Tapón de protección precintable
- Temperatura de trabajo de -20°C a 120°C
- Presión máxima de trabajo 25 bar.



WATERWORKS

GE-Block system patented by Genebre, designed for our against fraud valves let by means and special key, block the valve in open, close and 10% open positions.

Genebre's new Block Valve is intended for valves and pipes suppliers and for water supply companies from every country.

VALVES CHARACTERISTICS

- Brass construction UNE-EN 12164-12165
- Threaded ends ISO 228/1
- Connection ends for low, medium and high density PE pipe
- Sealable protection cap.
- Working temperature from -20°C to 120°C
- Maximum working pressure 25 bar.



Accionamiento antifraude latón / aluminio
Brass / aluminium against fraud handle



Accionamiento latón / aluminio
Brass / aluminium handle

PROCEDIMIENTO DE FUNCIONAMIENTO

WORKING PROCESS



Ref. 3430 - 3430N

● **Válvula antifraude recta H-H**
Disponible con rosca NPT (3430N)

Against fraud straight valve F-F
Available with NPT thread (3430N)

R	ØP	L	A	M
G1/2"	13,5	48	63	48,5
G3/4"	18	55	65,5	48,5

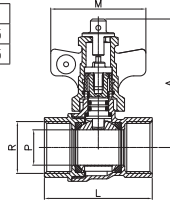

CÓDIGO CODE	MEDIDA SIZE	PESO WEIGHT	CAJA / BOX CARTON	P.V.P. € PRICE €
3430 04	1/2"	195	5-120	11,42
3430 05	3/4"	260	5-90	15,20
3430N 04	1/2"	195	5-120	11,42
3430N 05	3/4"	260	5-90	15,20

Ref. 3434

● **Válvula antifraude recta M-H**
Against fraud straight valve M-F

R	ØP	L	A	M
G1/2"	13,5	54,5	63	48,5
G3/4"	18	62,5	65,5	48,5

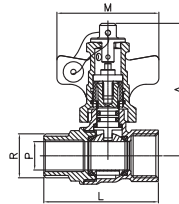

3434 04	1/2"	205	5-120	13,55
3434 05	3/4"	275	5-90	19,24

Ref. 3438

● **Válvula antifraude recta H-tuerca loca**
Against fraud straight valve F-free nut

r	R	ØP	L	A	M
G1/2"	G3/4"	13,5	59,5	63	48,5
G1/2"	G7/8"	13,5	59,5	63	48,5
G3/4"	G3/4"	13,5	65	65,5	48,5
G3/4"	G7/8"	13,5	65	65,5	48,5

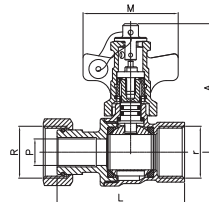

3438 04 05	1/2"x3/4"	255	10-120	14,88
3438 04 78	1/2"x7/8"	270	10-120	15,75
3438 05 05	3/4"x3/4"	320	8-96	18,67
3438 05 78	3/4"x7/8"	330	8-96	19,25

Ref. 3442

● **Válvula antifraude recta tubo PE-tuerca loca**
Against fraud straight valve PE-free nut

R	ØD	ØP	L	A	M
G3/4"	20	13,5	76	63	48,5
G3/4"	25	13,5	81	65,5	48,5
G1"	25	13,5	81	65,5	48,5

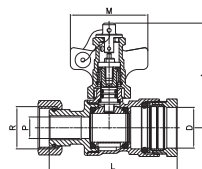

3442 20 05	PE20x3/4"	315	8-96	18,38
3442 25 05	PE25x3/4"	385	8-96	22,46
3442 25 06	PE25x1"	415	8-96	24,21

Ref. 3446

Válvula antifraude recta M-tuerca loca
Against fraud straight valve M-free nut



r	R	ØP	L	A	M
G 1/2"	G 3/4"	13,5	62,5	63	48,5
G 1/2"	G 7/8"	13,5	62,5	63	48,5
G 3/4"	G 3/4"	13,5	68,5	65,5	48,5
G 3/4"	G 7/8"	13,5	68,5	65,5	48,5

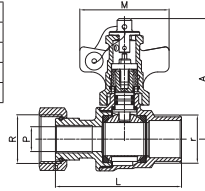

CÓDIGO CODE	MEDIDA SIZE	PESO WEIGHT	CAJA / BOX CARTON	P.V.P. € PRICE €
3446 04 05	1/2" x 3/4"	260	10-120	13,33
3446 05 05	3/4" x 3/4"	320	8-96	20,22

Ref. 3450

Válvula antifraude angular H-H
Against fraud angle valve F-F



R	ØP	L	A	M
G1/2"	13,5	24	63	48,5
G3/4"	18	27,5	65,5	48,5

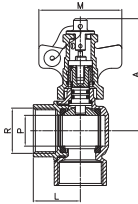

3450 04	1/2"	200	10-80	13,02
3450 05	3/4"	270	8-64	16,77

Ref. 3454

Válvula antifraude angular H-tuerca loca
Against fraud angle valve F-free nut



r	R	ØP	L	A	M
G1/2"	G3/4"	13,5	35,5	63	48,5
G3/4"	G3/4"	13,5	37,5	65,5	48,5

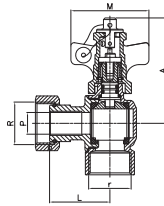

3454 04 05	1/2" x 3/4"	260	8-96	14,22
3454 05 05	3/4" x 3/4"	330	8-96	18,05

Ref. 3462

Válvula antifraude angular M-tuerca loca
Against fraud angle valve M-free nut



r	R	ØP	L	A	M
G1/2"	G 3/4"	13	35,5	63	48,5
G1/2"	G 7/8"	13	35,5	63	48,5
G3/4"	G 3/4"	13,5	37,5	65,5	48,5
G3/4"	G 7/8"	13,5	37,5	65,5	48,5

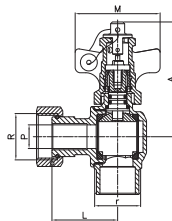

3462 04 05	1/2" x 3/4"	260	8-96	15,88
3462 04 78	1/2" x 7/8"	275	8-96	15,88
3462 05 05	3/4" x 3/4"	330	8-96	19,75
3462 05 78	3/4" x 7/8"	340	8-96	19,75

Ref. 3466

● Válvula antifraude recta H-tuerca loca con bloqueo para soporte
Against fraud straight valve - F-free nut with support block



r	R	ØP	L	A	M
G1/2"	G3/4"	13,5	86-101	63	48,5
G1/2"	G7/8"	13,5	86-101	63	48,5
G3/4"	G3/4"	15	91,5-106,5	65,5	48,5
G3/4"	G7/8"	15	91,5-106,5	65,5	48,5

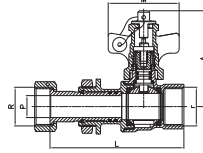

CÓDIGO CODE	MEDIDA SIZE	PESO WEIGHT	CAJA / BOX CARTON	P.V.P. € PRICE €
3466 04 05	1/2"x3/4"	350	1	20,18
3466 04 78	1/2"x7/8"	360	1	20,78
3466 05 05	3/4"x3/4"	405	1	23,36
3466 05 78	3/4"x7/8"	420	1	24,22

Ref. 3478

● Válvula antifraude angular H- tuerca loca con extensible y bloqueo para soporte



Against fraud angle valve F- free nut with expanding and support block

R	ØD	ØP	L	A	M
G1/2"	G3/4"	13,5	62-77	63	48,5
G1/2"	G7/8"	13,5	62-77	63	48,5
G3/4"	G3/4"	15	64-79	65,5	48,5
G3/4"	G7/8"	15	64-79	65,5	48,5

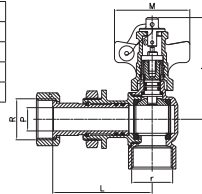

3478 04 05	1/2"x3/4"	350	1	-
3478 04 78	1/2"x7/8"	365	1	-
3478 05 05	3/4"x3/4"	415	1	-
3478 05 78	3/4"x7/8"	430	1	-

Precios a consultar / Prices on request

Ref. 3482

● Válvula antifraude angular tubo PE- tuerca loca con extensible y bloqueo para soporte
Against fraud angle valve PE pipe- free nut with expanding and support block



R	ØD	ØP	L	A	M
G3/4"	20	13,5	62-77	63	48,5
G3/4"	25	15	64-79	65,5	48,5
G1"	25	15	66-81	65,5	48,5

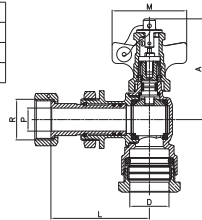

3482 20 05	PE20x3/4"	410	1	-
3482 25 05	PE25x3/4"	480	1	-
3482 25 06	PE25x1"	545	1	-

Precios a consultar / Prices on request

Ref. 3485

● Racor fijo con bloqueo para soporte



Fixed connector with block bracket

R	ØP	L
G3/4"	15	72
G1"	20	76

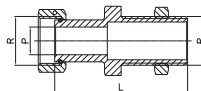

3485 05	3/4"x3/4"	230	1	-
3485 06	1"x1"	340	1	-

Precios a consultar / Prices on request

Ref. 3486

● Racor extensible con bloqueo para soporte



Expanding connector with block bracket

R	ØP	L
G3/4"	15	67-82
G1"	20	70-86

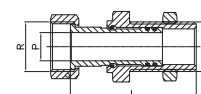

3486 05	3/4"x3/4"	240	1	-
3486 06	1"x1"	370	1	-

Precios a consultar / Prices on request

Ref. 3490

● Válvula antifraude recta para caja de empotrar

Against fraud straight valve for built-in box



r	R	OP	L	A	M
G3/4"	G3/4"	13,5	97	63	48,5
G3/4"	G7/8"	13,5	97	63	48,5

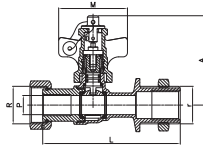

CÓDIGO CODE	MEDIDA SIZE	PESO WEIGHT	CAJA / BOX CARTON	P.V.P. € PRICE €
3490 05 00	3/4" (1/2") x 3/4"	350	1	18,54
3490 05 78	3/4" (1/2") x 7/8"	365	1	18,54

Precios a consultar / Prices on request

Ref. 3491

● Racor recto con extensible

Straight connector with expanding



R	ØD	OP	L
G3/4"	G3/4"	15	67-82
G3/4"	G7/8"	15	67-82

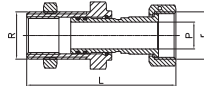

3491 05 05	3/4" (1/2") x 3/4"	240	1	12,08
3491 05 78	3/4" (1/2") x 7/8"	255	1	12,08

Precios a consultar / Prices on request

Ref. 3499

● Llave accionamiento antifraude

Antitheft manual control key



Ref.	A	B
3499 00	67	65
3499 02	163	85

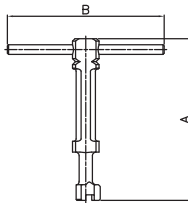

3499 00	-	30	1	11,14
3499 02	-	75	1	-

Precios a consultar / Prices on request

Ref. 3084

● Válvula de esfera mando cuadradillo

PN 25. Paso total. Construcción en latón UNE-EN 12165 cromado. Asientos PTFE. Extremos rosca gas (BSP) H-H - ISO 228/1. Temp. máx. 180°C. Accionamiento mediante cuadradillo.

Square handle ball valve

PN 25. Full bore. Body chrome plated brass UNE-EN 12165. PTFE seats. Gas threaded ends (BSP) F-F - ISO 228/1. Max. Temp. 180°C. Square handle.



R	P	A	L	M
1/2"	15	38	49	20
3/4"	20	49	56	20
1"	25	52	68	20
1 1/4"	32	63	80	30
1 1/2"	40	69	89	30
2"	50	80	104	30
2 1/2"	60	89	137	30
3"	74	117	158	30
4"	92	131	183	30

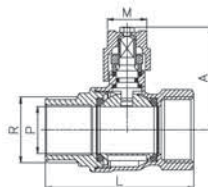

3084 04	1/2"	160	15-210	5,28
3084 05	3/4"	255	10-140	8,30
3084 06	1"	380	8-80	12,41
3084 07	1 1/4"	610	5-40	20,04
3084 08	1 1/2"	855	2-24	29,14
3084 09	2"	1310	2-16	44,57
3084 10	2 1/2"	2430	1-8	83,94
3084 11	3"	3950	1-4	128,30
3084 12	4"	5985	1-2	208,33

Ref. 3085



Válvula de esfera mando cuadradillo
 PN 25. Paso total. Construcción en latón UNE-EN 12165 cromado. Asientos PTFE. Extremos rosca gas (BSP) M-H - ISO 228/1. Temp. máx. 180°C. Accionamiento mediante cuadradillo.

Square handle ball valve
 PN 25. Full bore. Body chrome plated brass UNE-EN 12165. PTFE seats. Gas threaded ends (BSP) M-F - ISO 228/1. Max. Temp. 180°C. Square handle.

R	P	A	L	M
1/2"	15	38	55	20
3/4"	20	49	64	20
1"	25	52	76	20
1 1/4"	32	63	87	30
1 1/2"	40	69	95	30
2"	50	80	109	30

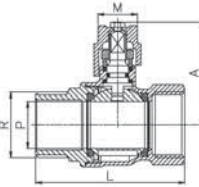

CÓDIGO CODE	MEDIDA SIZE	PESO WEIGHT	CAJA / BOX CARTON	P.V.P. € PRICE €
3085 04	1/2"	170	10-180	5,71
3085 05	3/4"	265	6-108	9,00
3085 06	1"	395	6-72	13,50
3085 07	1 1/4"	640	5-40	21,07
3085 08	1 1/2"	865	2-20	29,72
3085 09	2"	1315	2-16	45,59

Ref. 3051



Válvula esfera recta con palomilla tuerca loca
 PN 16. Paso reducido. Construcción en latón según UNE-EN 12165. Asientos PTFE. Rosca gas (BSP) M-H tuerca loca según ISO 228/1. Temp. máx. 140°C. Accionamiento mediante palomilla.

Straight ball valve with butterfly handle - free nut
 PN 16. Reduced bore. Body brass UNE-EN 12165. PTFE seats. Gas threaded (BSP) M-F free nut - ISO 228/1. Max. temp. 140°C. Butterfly handle operated.

R	P	A	L	M
1/2"x3/4"	10	34	45	40

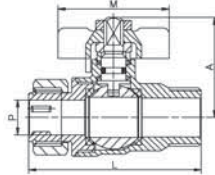

3051 04 05	1/2"x3/4"	135	25-200	7,69
------------	-----------	-----	--------	------

Ref. 3088



Válvula de esfera tubería PE
 PN-16. Paso total. Construcción en latón s/UNE-EN 12165. Extremos conexión a tubería mediante sistema de apriete diseño Genebre "RAC-GE". Temperatura de trabajo de -20°C a +110°C. Aplicable para la unión de tubo de polietileno de baja - media y alta densidad.

Ball valve for PE pipe
 PN 16. Full bore. Brass construction UNE-EN 12165. Genebre's designed "RAC-GE" air tight system ends for connection to pipe. Working temp.: -20 °C to 110 °C. Applicable for the connection of low - medium and high density polyethylene pipe.

DN	ØPE	P	A	L	M
15	20	14	47	77	84
20	25	19	58	91	98
25	32	24	61	109	98

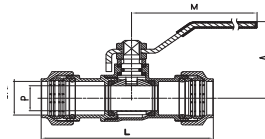

3088 04	20x20	235	6-108	6,48
3088 05	25x25	390	6-72	10,73
3088 06	32x32	585	3-36	16,08

Ref. 3089



Válvula de esfera tubería PE
 PN-16. Paso total. Construcción en latón s/UNE-EN 12165. Extremos roscado gas hembra s/ISO 228/1. Conexión a tubería mediante sistema de apriete diseño Genebre "RAC-GE". Temperatura de trabajo de -20°C a + 110°C. Aplicable para la unión de tubo de polietileno de baja - media y alta densidad.

Ball valve for PE pipe
 PN 16. Full bore. Brass UNE-EN 12165. Female gas threaded ends ISO 228/1. Genebre's designed "RAC-GE" air tight system for connection to pipe. Working temp.: -20 °C to 100 °C. Applicable for the connection of low - medium and high density polyethylene pipe.

DN	ØPE	P	A	L	M
15	20	14	47	61	84
20	25	19	58	71	98
25	32	24	61	86	98

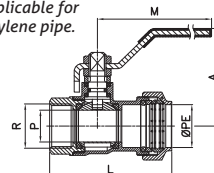

3089 04	1/2"x20	195	8-144	5,50
3089 05	3/4"x25	325	6-72	9,14
3089 06	1"x32	490	4-48	13,65



2

CLIMATIZACIÓN CLIMATE CONTROL

Válvulas de calefacción,
de seguridad, motorizadas,
colectores, termostatos,
válvulas para energía solar
y bombas de condensación.

*Heating valves, safety valves,
motorized zone valves,
manifolds, thermostats, solar
energy valves and condensat
pumps.*



SISTEMA DE CALEFACCIÓN GENEBRE

GENEBRE HEATING SYSTEM

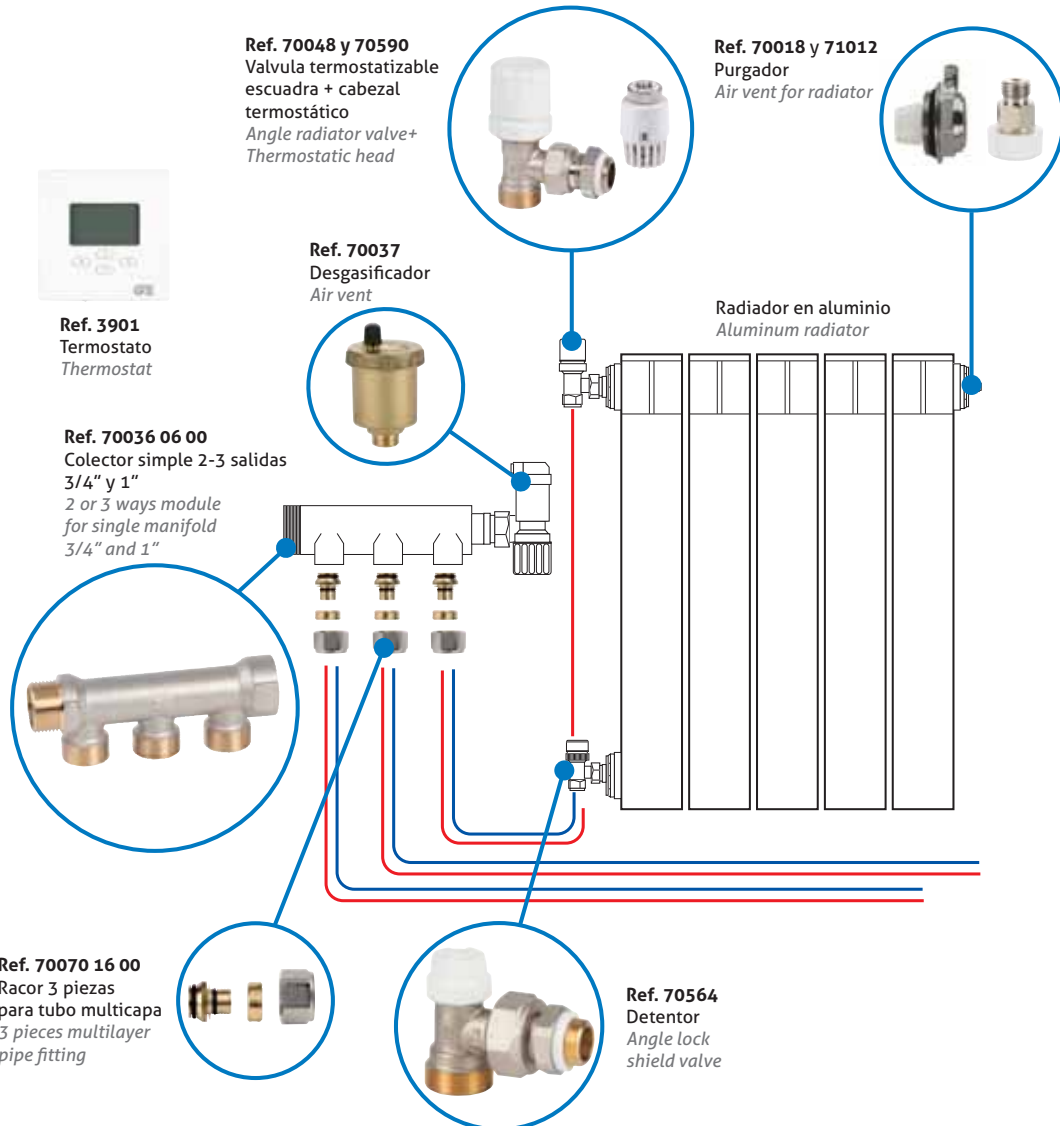

CARACTERÍSTICAS DE LAS VÁLVULAS

Para tubo hierro

Construcción en latón UNE-EN 12164-12165.
Volante en ABS.
Conexión a tubería (hembra) mediante rosca ISO 228/1.
Conexión al emisor rosca macho ISO 228/1, con junta PTFE para Ge System.
Temp. Máx. de trabajo 110°C.
Presión máx. de trabajo 10 bar.

Para tubo de cobre, PEX o multicapa

Construcción en latón UNE-EN 12164-12165.
Volante en ABS.
Conexión a tubería de cobre y plástico mediante racor de compresión* (ver enlaces de compresión).
Rosca macho W24,5 x 19h/1".
Conexión al emisor rosca macho ISO 228/1, con junta PTFE para Ge System.
Temp. máx. trabajo 110°C.
Presión máx. trabajo 10bar.

VALVES CHARACTERISTICS

For steel pipe

Brass construction UNE-EN 12164-12165.
ABS steering wheel.
Pipe connection (female) thread ISO 228/1.
Terminal connection male thread ISO 228/1, with PTFE joint for Ge System.
Max. working temp. 110°C.
Max. working pressure 10 bar.

For cooper, polyethylene or multilayer pipe

Brass construction UNE-EN 12164-12165.
ABS steering wheel.
Cooper and plastic connection by means a compression fitting* (see compression fittings).
Male thread W24,5 x 19h/1".
Terminal connection male thread ISO 228/1, with PTFE joint for Ge System.
Max. working temp. 110°C.
Max. working pressure 10bar.

VÁLVULAS DE ESCUADRA Y RECTAS PARA TUBO HIERRO CON GE SYSTEM /
ANGLE AND STRAIGHT VALVES FOR STEEL PIPE WITH GE SYSTEM

Ref. 70151

● Válvula manual escuadra para tubo de hierro con GE System



Manual angle radiator valve for steel pipe with GE System

MED/SIZE	L	H
3/8"	69	48
1/2"	69	51



CÓDIGO CODE	MEDIDA SIZE	PESO WEIGHT	CAJA / BOX CARTON	P.V.P. € PRICE €
70151 03 00	3/8"	170	10-140	5,97
70151 04 00	1/2"	175	10-140	6,27

Ref. 70152

● Válvula manual recta para tubo de hierro con GE System



Manual straight radiator valve for steel pipe with GE System

MED/SIZE	L	H
3/8"	73	56
1/2"	76	56

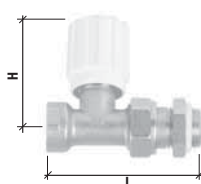

70152 03 00	3/8"	190	10-140	7,48
70152 04 00	1/2"	195	10-140	7,86

Ref. 70153

● Detentor escuadra para tubo de hierro con GE System



Angle adjusting lock shield valve for steel pipe with GE System

MED/SIZE	L	H
3/8"	42	48
1/2"	42	51

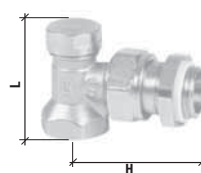

70153 03 00	3/8"	150	10-140	5,43
70153 04 00	1/2"	155	10-140	5,70

Ref. 70154

● Detentor recto para tubo de hierro con GE System



Straight adjusting lock shield valve for steel pipe with GE System

MED/SIZE	L	H
3/8"	73	29
1/2"	76	29

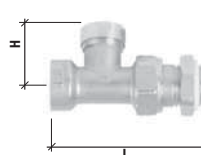

70154 03 00	3/8"	170	10-140	7,17
70154 04 00	1/2"	175	10-140	7,53

VÁLVULAS DE ESCUADRA Y RECTAS PARA TUBO COBRE-POLIETILENO-MULTICAPA CON GE SYSTEM /
ANGLE AND STRAIGHT VALVES FOR COPPER, POLYETHYLENE AND MULTILAYER PIPE WITH GE SYSTEM

CÓDIGO CODE	MEDIDA SIZE	PESO WEIGHT	CAJA / BOX CARTON	P.V.P. € PRICE €
70587 03 00	3/8"	170	10-140	5,66
70587 04 00	1/2"	185	10-140	5,94

Ref. 70587

● Válvula manual escuadra para tubo de cobre, PEX o multicapa con GE System



Manual angle radiator valve for cooper, polyethylene or multilayer pipe with GE System

MED/SIZE	L	H
3/8"	70	49
1/2"	70	52



Ref. 70588

● Válvula manual recta para tubo de cobre, PEX o multicapa con GE System



Manual straight radiator valve for cooper, polyethylene or multilayer pipe with GE System

MED/SIZE	L	H
3/8"	74	56
1/2"	77	56

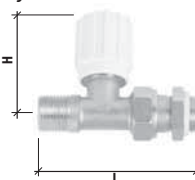

70588 03 00	3/8"	190	10-140	7,20
70588 04 00	1/2"	205	10-140	7,56

Ref. 70564

● Detentor escuadra para tubo cobre, PEX o multicapa con GE System



Angle lock shield valve for copper, PEX or multilayer pipe with GE System

MED/SIZE	L	H
3/8"	44	49
1/2"	44	52



70564 03 00	3/8"	135	10-140	5,09
70564 04 00	1/2"	145	10-140	5,35

Ref. 70565

● Detentor recto para tubo cobre, PEX o multicapa con GE System



Straight lock shield valve for copper, PEX or multilayer pipe with GE System

MED/SIZE	L	H
3/8"	74	29
1/2"	77	29

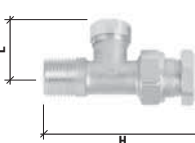

70565 03 00	3/8"	170	10-140	6,89
70565 04 00	1/2"	180	10-140	7,23

VÁLVULAS DE ESCUADRA Y RECTAS PARA TUBO HIERRO/
ANGLE AND STRAIGHT VALVES FOR STEEL PIPE

Ref. 70151

● Válvula manual escuadra para tubo de hierro



Manual angle radiator valve for steel pipe

MED/SIZE	L	H
3/8"	69	48
1/2"	69	51

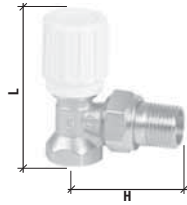

CÓDIGO CODE	MEDIDA SIZE	PESO WEIGHT	CAJA / BOX CARTON	P.V.P. € PRICE €
70151 03 40	3/8"	160	10-140	5,56
70151 04 40	1/2"	160	10-140	5,83

Ref. 70152

● Válvula manual recta para tubo de hierro



Manual straight radiator valve for steel pipe

MED/SIZE	L	H
3/8"	73	56
1/2"	76	56

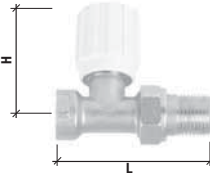

70152 03 40	3/8"	180	10-140	6,97
70152 04 40	1/2"	180	10-140	7,32

Ref. 70153

● Detentor escuadra para tubo de hierro



Angle adjusting lock shield valve for steel pipe

MED/SIZE	L	H
3/8"	42	48
1/2"	42	51

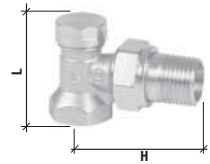

70153 03 40	3/8"	140	10-140	4,87
70153 04 40	1/2"	140	10-140	5,12

Ref. 70154

● Detentor recto para tubo de hierro



Straight adjusting lock shield valve for steel pipe

MED/SIZE	L	H
3/8"	73	29
1/2"	76	29

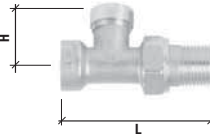

70154 03 40	3/8"	160	10-140	6,65
70154 04 40	1/2"	160	10-140	6,98

VÁLVULAS DE ESCUADRA Y RECTAS PARA TUBO COBRE-POLIETILENO-MULTICAPA /
ANGLE AND STRAIGHT VALVES FOR COPPER, POLYETHYLENE AND MULTILAYER PIPE

Ref. 70587

● Válvula manual es cuadra para tubo de cobre, PEX o multicapa



Manual angle radiator valve for cooper, polyethylene or multilayer pipe

MED./SIZE	L	H
3/8"	70	49
1/2"	70	52



CÓDIGO CODE	MEDIDA SIZE	PESO WEIGHT	CAJA / BOX CARTON	P.V.P. € PRICE €
70587 03 40	3/8"	155	10-140	5,24
70587 04 40	1/2"	170	10-140	5,51

Ref. 70588

● Válvula manual recta para tubo de cobre, PEX o multicapa



Manual straight radiator valve for cooper, polyethylene or multilayer pipe

MED./SIZE	L	H
3/8"	74	56
1/2"	77	56

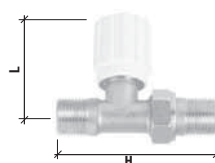

70588 03 40	3/8"	175	10-140	6,79
70588 04 40	1/2"	190	10-140	7,13

Ref. 70564

● Detentor escuadra para tubo cobre, PEX o multicapa



Angle lock shield valve for cooper, PEX or multilayer pipe

MED./SIZE	L	H
3/8"	44	49
1/2"	44	52

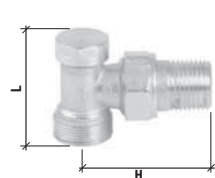

70564 03 40	3/8"	135	10-140	4,68
70564 04 40	1/2"	145	10-140	4,91

Ref. 70565

● Detentor recto para tubo cobre, PEX o multicapa



Straight lock shield valve for cooper, PEX or multilayer pipe

MED./SIZE	L	H
3/8"	74	29
1/2"	77	29

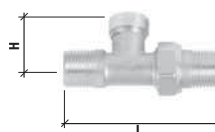

70565 03 40	3/8"	155	10-140	6,48
70565 04 40	1/2"	165	10-100	6,80

VÁLVULAS TERMOSTATIZABLES DE ESCUADRA Y RECTAS PARA TUBO HIERRO /
ANGLE AND STRAIGHT THERMOSTATIC VALVES FOR STEEL PIPE

Ref. 70031

- Válvula termostaticable escuadra para tubo de hierro con GE System



Angle radiator valve with thermostatic option, for steel pipe with GE System

MED/SIZE	L	H
3/8"	83	48
1/2"	83	51



CÓDIGO CODE	MEDIDA SIZE	PESO WEIGHT	CAJA / BOX CARTON	P.V.P. € PRICE €
70031 03 00	3/8"	220	10-80	7,82
70031 04 00	1/2"	225	10-80	8,21

Ref. 70032

- Válvula termostaticable recta para tubo de hierro con GE System



Straight radiator valve with thermostatic option, for steel pipe with GE System

MED/SIZE	L	H
3/8"	73	70
1/2"	76	70

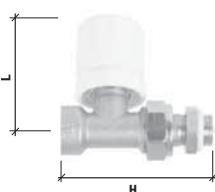

70032 03 00	3/8"	240	10-80	9,78
70032 04 00	1/2"	245	10-80	10,27

Ref. 70153

- Detentor escuadra para tubo de hierro con GE System



Angle adjusting lock shield valve for steel pipe with GE System

MED/SIZE	L	H
3/8"	42	48
1/2"	42	51

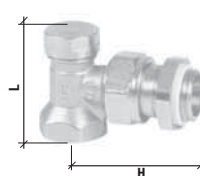

70153 03 00	3/8"	150	10-140	5,43
70153 04 00	1/2"	155	10-140	5,70

Ref. 70154

- Detentor recto para tubo de hierro



Straight adjusting lock shield valve for steel pipe

MED/SIZE	L	H
3/8"	73	29
1/2"	76	29



70154 03 00	3/8"	170	10-140	7,17
70154 04 00	1/2"	175	10-140	7,53

VÁLVULAS TERMOSTATIZABLES DE ESCUADRA Y RECTAS PARA TUBO COBRE-POLIETILENO-MULTICAPA /
ANGLE AND STRAIGHT THERMOSTATIC VALVES FOR COPPER, POLYETHYLENE AND MULTILAYER PIPE

Ref. 70048

● Válvula termostatizable escuadra para tubo cobre, polietileno o multicapa con GE System



Angle radiator valve with thermostatic option, for copper or polyethylene pipe with GE System

MED/SIZE	L	H
3/8"	84	49
1/2"	84	52



CÓDIGO CODE	MEDIDA SIZE	PESO WEIGHT	CAJA / BOX CARTON	P.V.P. € PRICE €
70048 03 00	3/8"	210	10-80	7,82
70048 04 00	1/2"	230	10-80	8,21

Ref. 70049

● Válvula termostatizable recta para tubo cobre, polietileno o multicapa con GE System



Straight radiator valve with thermostatic option, for copper or polyethylene pipe with GE System

MED/SIZE	L	H
3/8"	74	70
1/2"	77	70

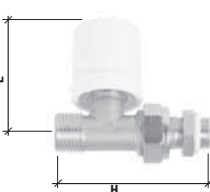

70049 03 00	3/8"	230	10-100	9,48
70049 04 00	1/2"	250	10-100	9,96

Ref. 70564

● Detentor escuadra para tubo cobre, PEX o multicapa con GE System



Angle lock shield valve for copper, PEX or multilayer pipe with GE System

MED/SIZE	L	H
3/8"	44	49
1/2"	44	52



70564 03 00	3/8"	135	10-140	5,09
70564 04 00	1/2"	145	10-140	5,35

Ref. 70565

● Detentor recto para tubo cobre, PEX o multicapa con GE System



Straight lock shield valve for copper, PEX or multilayer pipe with GE System

MED/SIZE	L	H
3/8"	74	29
1/2"	77	29

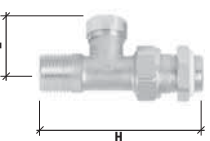

70565 03 00	3/8"	170	10-140	6,89
70565 04 00	1/2"	180	10-100	7,23

Ref. 70590



Cabezal termostático

Uso para válvulas termostáticas. Construcción en ABS ignífugo. Rango de temperaturas de 6°C a 28°C con dispositivo antihielo. Sensor líquido de expansión por calor. Conexión rosca M30 x 1,5. Presión máx. de trabajo 10bar. Temp. máx. de trabajo 50°C. Dimensiones 81x Ø48.

Thermostatic head

For thermostatic valves use. ABS fireproof construction. Temperature range from 6°C to 28°C with defrosting device. Liquid sensor heat expansion. Thread connection M30 x 1,5. Max. working pressure 10bar. Max. working temp. 50°C. Dimensions 81x Ø48.

CÓDIGO CODE	MEDIDA SIZE	PESO WEIGHT	CAJA / BOX CARTON	P.V.P. € PRICE €
70590 00 00	M30x1,5	115	1-144	14,46

Ref. 70306



Cabezal electrotérmico para válvulas termostáticas

Alimentación: 24/230V. Construcción en ABS ignífugo. Sensor de cera electrotérmico. Cable de dos hilos. Posición de la válvula n/c. Clase de protección IP 40. Temp. Máx. de trabajo 50°C. Presión máxima de trabajo 10 bar.

Electrothermal control for thermostatic valves

Power supply: 24/230V. ABS fireproof construction. Electrothermal wax sensor. Two wire cable. Normally closed valve position. Protection class IP 40. Max. working pressure 10 bar.

70306 00 02	M30x1,5	110	1-100	22,79
70306 00 12	M30x1,5	110	1-100	22,79

70306 00 02	220/230 V
70306 00 12	24 V

Ref. 71028



Válvula monotubo termostaticable

Construcción en latón UNE-EN 12164-12165. Juntas de cierre en elastómero. Volante en ABS. Conexión al emisor rosca macho ISO 228/1. Conexión a tubería de cobre y plástico mediante racor. Rosca macho W24,5 x 19h/1". Mando manual intercambiable. Sonda de entrada incorporada. Temp. Máx. de trabajo 110°C. Presión máx. de trabajo 10 bar.

Thermostatic valve for single-pipe installation

Brass construction UNE-EN 12164-12165. Elastomer sealing joints. ABS steering wheel. Terminal connection male thread ISO 228/1. Cooper and plastic connection by means a fitting. Male thread W24,5 x 19h/1". Easy replaceable manual control. Inlet probe incorporated. Max. working temp. 110°C. Max. working pressure 10 bar.

71028 04 00	1/2"	485	4-48	21,82
-------------	------	-----	------	-------

MED/SIZE	L	H	E	D
1/2"	146	49	35	258

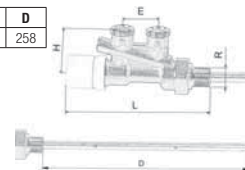

Ref. 70041



Racor tubo cobre

Tuerca y casquillo en latón. Tuerca níquelada. Junta de cierre en NBR. Rosca hembra W24,5x19h/1". Temp. máx. de trabajo 95°C. Presión máx. de trabajo 10 bar.

Copper pipe fitting

Nut and ring in brass. Nickel-plated nut. NBR sealing joint. Female thread W24,5x19h/1". Max. working temp. 95°C. Max. working pressure 10 bar.

70041 12 20	Ø 12	31	10-500	2,60
70041 15 20	Ø 15	31	10-500	2,60

Ref. 70071



Racor tubo polietileno reticulado (PEX)

Construcción en latón. Tuerca níquelada. Junta de cierre en NBR. Rosca hembra W24,5x19h/1". Temperatura máxima de trabajo 95°C. Presión máxima de trabajo 10 bar.

PEX polyethylene pipe fitting

Brass construction. Nickel-plated nut. NBR sealing joint. Female thread W24,5x19h/1". Maximum working temperature 95°C. Maximum working pressure 10 bar.

70071 16 00	Ø 16x2	50	10-300	2,81
70071 16 20	Ø 16x1,5	53	10-300	2,81

Ref. 70070



Racor tubo multicapa

Construcción en latón. Tuerca níquelada. Juntas de cierre en NBR. Rosca hembra W24,5x19h/1". Temp. máx. de trabajo 95°C. Presión máx. de trabajo 10 bar.

Multilayer pipe fitting

Brass construction. Nickel-plated nut. NBR sealing joints. Female thread W24,5x19h/1". Max. working temp. 95°C. Max. working pressure 10 bar.

70070 16 00	Ø 16x2	52	10-300	2,97
70070 18 00	Ø 18x2	52	10-300	2,97
70070 20 00	Ø 20x2	50	10-300	2,97
70070 20 20	Ø 20x2,25	50	10-300	2,97

Ref. 3907



Sensor de temperatura

Termistor NTC como elemento sensitivo. Rango temperatura de trabajo: 0°C-120°C. Caja en plástico técnico PC-HT ignifugo. Terminal del cable en ABS ignifugo. Clase de protección IP54. Varilla en latón niquelado.

Temperature sensor

NTC thermistor as a sensitive element. Working temperature range: 0°C-120°C. Box in fireproof PC-HT engineering plastic. Wiring terminal in fireproof ABS. Protection class IP54. Rod in nickel-plated brass.

MED/SIZE	dimensiones/dimensions	
	A	B
1/2"	10	120

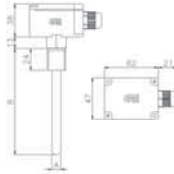

CÓDIGO CODE	MEDIDA SIZE	PESO WEIGHT	CAJA / BOX CARTON	P.V.P. € PRICE €
3907 00	1/2"	215	1-20	29,75

Ref. 3179 - 3189



Válvula de seguridad escuadra-3 bar (3179)

Válvula de seguridad escuadra-6 bar (3189)

Cuerpo en latón. Muelle de acero INOX AISI 302. Obturador en EPDM. Membrana en EPDM. Extremos roscados hembra-hembra ISO 228/1. Presión máx. de trabajo 10bar. Temp. máx. 90°C.

Safety relief angle valve-3 bar (3179)

Safety relief angle valve-6 bar (3189)

Brass body. Stainless steel AISI 302 spring. EPDM joint. EPDM membrane. Female-female threaded ends ISO 228/1. Max. working pressure 10bar. Max. working temp. 90°C.

3179 04	1/2"	116	10-100	6,61
3189 04	1/2"	116	10-100	6,61

Ref. 3182 - 3188



Válvula de seguridad escuadra-3 bar (3182)

Válvula de seguridad escuadra-6 bar (3188)

Cuerpo en latón. Muelle de acero inox AISI 302. Obturador en EPDM. Membrana en EPDM. Extremos roscados macho-hembra ISO 228/1. Presión máx. de trabajo 10bar. Temperatura máx. 90°C.

Safety relief angle valve-3 bar (3182)

Safety relief angle valve-6 bar (3188)

Brass body. Stainless steel AISI 302 spring. EPDM joint. EPDM membrane. Male-female threaded ends ISO 228/1. Max. working pressure 10bar. Max. working temp. 90°C.

3182 04	1/2"	118	10-100	6,90
3188 04	1/2"	118	10-100	6,90

Ref. 3191 - 3192



Válvula de seguridad escuadra con conexión manómetro-3 bar (3191)

Válvula de seguridad escuadra con conexión manómetro-6 bar (3192)

Cuerpo en latón. Muelle de acero INOX AISI 302. Obturador en EPDM. Membrana en EPDM. Extremos roscados macho-hembra ISO 228/1. Presión máx. de trabajo 10bar. Temp. máx. 90°C. Conexión para manómetro hembra 1/4" ISO 228/1.

Safety relief angle valve with pressure gauge connection-3 bar (3191)

Safety relief angle valve with pressure gauge connection-6 bar (3192)

Brass body. Stainless steel AISI 302 spring. EPDM joint. EPDM membrane. Male-female threaded ends ISO 228/1. Max. working pressure 10bar. Max. working temp. 90°C. 1/4" female pressure gauge connection ISO 228/1.

3191 04	1/2"	114	10-100	8,46
3192 04	1/2"	114	10-100	8,46

Ref. 70017

● **Purgador manual de aire orientable**

PN 10. Construcción en latón UNE-EN 12164 niquelado. Juntas de cierre en EPDM. Orificio de purga orientable 360°. Conexión rosca gas (BSP) macho ISO 228/1. Temp. máx. trabajo 100°C.



Orientable manual air vent

PN 10. Nickel plated brass construction UNE-EN 12164. EPDM sealing O-rings. Vent hole orientable 360°. Gas threaded end (BSP) male, ISO 228/1. Max. working temp. 100°C

R	A	B	C	E (Hex)
1/8"	13	21	24	14

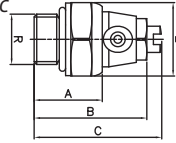

CÓDIGO CODE	MEDIDA SIZE	PESO WEIGHT	CAJA / BOX CARTON	P.V.P. € PRICE €
70017 01 00	1/8"	15	100-1000	0,90

Ref. 70018

● **Purgador manual de aire**

Cuerpo en latón niquelado. Mando de control no conductor de calor. Unión rosca macho ISO 228. Presión máx. 6 bar. Temp. máx. 100°C.



Manual air vent

Nickel-plated brass body. Heatless control handle. Threads connection male ISO 228. Max. working pressure 6bar. Max. working temp. 100°C.

R	D	A
1/8"	17,5	27

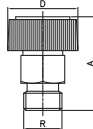

70018 01 02	1/8"	12	10-1000	0,74
-------------	------	----	---------	------

Ref. 71012

● **Purgador automático de aire**

Cuerpo en latón niquelado. Junta en EPDM. Flotador en polietileno. Unión rosca M-ISO 228. Presión máx. 10bar. Temp. máx. de trabajo 110°C.



Automatic air vent valve

Nickel-plated brass body. EPDM joint. Polyethylene float. Male thread connections ISO 228. Max. working pressure 10 bar. Max. working temp. 110°C.

R	A	B	C	D
G 1"	57,5	31	37,5	42

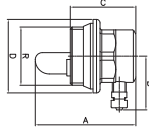

71012 06 02	DCHO/RIGHT	102	10-100	6,12
71012 06 13	IZQ./LEFT	102	10-100	6,12

Ref. 70037

● **Purgador automático de aire**

Cuerpo en latón. Sistema de flotador en PP. Junta de cierre en elastómero. Extremo rosca macho ISO 228/1. Temp. máx. 110°C. Presión máxima de trabajo 10 bar.



Automatic air vent

Body brass. PP floating system. Elastomer sealing joint. Male thread ISO 228/1. Max. working temp. 110°C. Maximum working pressure 10 bar.

R	A	D	H
G3/8"	75	46	60
G1/2"	74	46	60
G3/4"	73	46	59
G1"	99	51	85

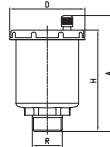

70037 03 02	3/8"	155	10-80	5,85
70037 04 02	1/2"	155	10-80	6,82
70037 05 02	3/4"	170	10-80	11,36
70037 06 02	1"	235	10-100	-

Ref. 70038

● **Purgador automático de aire con cierre manual y conexión lateral**

Cuerpo en latón. Sistema de flotador en PP. Junta de cierre en elastómero. Extremo rosca macho ISO 228/1. Temp. máx. 115°C.



Automatic air vent with manual lockin plug and lateral connection

Body brass. PP floating system. Elastomer sealing joint. Male thread ISO 228/1. Max. working temp. 115°C.

R	A	D	H	L
G3/8"	53	46	46	53
G1/2"	53	46	46	55

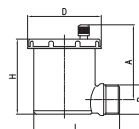

70038 03 00	3/8"	155	10-80	9,56
70038 04 00	1/2"	170	10-80	9,89

Ref. 70037



Degasificador automático

Cuerpo en latón niquelado. Flotador en PP. Junta de cierre en elastómero. Extremo rosca macho ISO 228/1. Temperatura máx. fluido 100°C. Presión máx. trabajo 6 bar. Presión máx. transitoria 16 bar.

Automatic degassing device

Nickle-plated brass body. PP float. Elastomer sealing joint. Male thread end ISO 228/1. Max. fluid temperature 100°C. Max. working pressure 6 bar. Max. transient pressure 16 bar.

MED/SIZE	A	D
3/8"	112	48
1/5"	114	48
3/4"	116	48

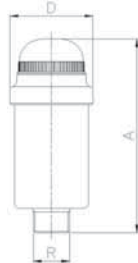

CÓDIGO CODE	MEDIDA SIZE	PESO WEIGHT	CAJA / BOX CARTON	P.V.P. € PRICE €
70037 03 60	3/8"	255	10-100	23,54
70037 04 60	1/2"	260	10-100	23,54
70037 05 60	3/4"	270	10-100	-

Ref. 70035



Colector simple componible 2, 3 y 4 vías

Construcción en latón niquelado. Conexión en derivación lateral rosca macho W24,5x19h/1". Conexión en línea rosca macho, hembra ISO 228/1. Temperatura máxima de trabajo: 180°C. Presión máxima de trabajo: 10 bar.

2, 3 and 4 ways module single manifold

Nickle-plated brass construction. Lateral branch connection male thread W24,5x19h/1". Threaded ends connection male-female ISO 228/1. Maximum working temperature: 180°C. Maximum working pressure: 10 bar.

R	Nº Derivaciones / Branches nº	DN	L	X
3/4"	2	20	87	36
3/4"	3	20	123	36
3/4"	4	20	159	36
1"	2	25	105	42
1"	3	25	147	42
1"	4	25	189	42

70035 05 02	3/4"	195	8-64	6,93
70035 05 03	3/4"	260	5-40	9,48
70035 05 04	3/4"	325	4-32	15,26
70035 06 02	1"	325	8-64	11,71
70035 06 03	1"	440	5-40	15,41
70035 06 04	1"	555	4-32	20,24

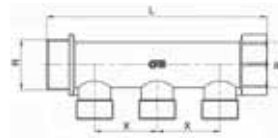

Ref. 70171



Colector simple componible sanitario con regulación 2, 3 y 4 vías
 Construcción en latón niquelado. Juntas en elastómero. Volante en ABS antirobo. Conexión en derivación lateral rosca macho W24,5x19h/1". Conexión en línea rosca macho, hembra ISO 228/1. Temperatura máxima de trabajo: 110°C. Presión máxima de trabajo: 10 bar. Con placa reversible indicadora de agua fría (azul) y caliente (roja).

2, 3 and 4 ways modular sanitary manifold with adjustment

Nickle-plated brass construction. Elastomer joints. ABS against steering wheel. Lateral branch connection male thread W24,5x19h/1". Threaded ends connection male-female ISO 228/1. Maximum working temperature: 110°C. Maximum working pressure: 10 bar. With reversible metal sheet which indicates cold water (blue) and hot water (red).

R	Nº Derivaciones / Branches nº	DN	L	X
3/4"	2	20	88	36
3/4"	3	20	124	36
3/4"	4	20	160	36
1"	2	25	101	43
1"	3	25	144	43
1"	4	25	187	43

70171 05 02	3/4"	360	5-40	21,51
70171 05 03	3/4"	520	5-30	31,21
70171 05 04	3/4"	660	4-24	42,44
70171 06 02	1"	460	5-40	25,31
70171 06 03	1"	655	5-30	36,69
70171 06 04	1"	855	4-24	51,62

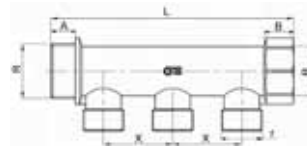

Ref. 70175

● Colector de distribución
Tubo de 1", salidas de 1/2"



*Manifold double side
1" pipe, 1/2" outlets*

CÓDIGO CODE	MEDIDA SIZE	PESO WEIGHT	CAJA / BOX CARTON	P.V.P. € PRICE €
70175 06 04	1"	-	1	24,48
70175 06 05	1"	-	1	29,94
70175 06 06	1"	-	1	35,61
70175 06 07	1"	-	1	41,68
70175 06 08	1"	-	1	47,23

Ref. 70176

● Colector de distribución AISI 304
Tubo de 1", salidas de 1/2"



*Manifold double side AISI 304
1" pipe, 1/2" outlets*

70176 06 04	1"	-	1	29,35
70176 06 05	1"	-	1	32,90
70176 06 06	1"	-	1	36,46
70176 06 07	1"	-	1	40,01
70176 06 08	1"	-	1	43,57

Ref. 3073

● Válvula de equilibrado
PN 20. Construcción cuerpo y componentes internos en latón.
Juntas VITON, Extremos rosca gas (BSP) H-H, ISO 228/1. Toma de presión G1/8" H. Temperatura trabajo de -30°C a 120°C.



*Balancing valve
PN 20. Brass construction of body and inner components. Gas threaded ends (BSP) F-F, ISO 228/1. Pressure taps connection G1/8" F. Working temperature from -30°C to 120°C.*

R	A	B	C	D
1/2"	84	15	96	22
3/4"	85,6	17,8	97	21,5
1"	98	21,3	103,3	29,5
1 1/4"	101	28	111	29
1 1/2"	107	31	120	27
2"	115	37	132	21,9

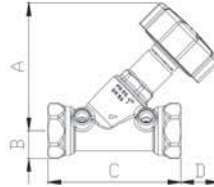

3073 04	1/2"	500	1	47,38
3073 05	3/4"	500	1	50,53
3073 06	1"	700	1	56,41
3073 07	1 1/4"	1000	1	61,61
3073 08	1 1/2"	1000	1	72,14
3073 09	2"	1800	1	114,77

Ref. 70080

● Racor macho orientable para colectores

Adjustable male end fitting for manifolds



70080 06 00	1"	-	1	8,29
70080 07 00	1"- 1 1/4"	-	1	10,96

Ref. 70081

● Tapón macho con junta

Male end cap with O'ring



70081 06 00	1"	-	1	3,56
-------------	----	---	---	------

Ref. 70082

● Racor macho con junta

Male end fitting with o'ring



70082 06 04	1"x 1 1/2"	-	1	3,63
-------------	------------	---	---	------

Ref. 70083

● Medidor de caudal



Flow meter

CÓDIGO CODE	MEDIDA SIZE	PESO WEIGHT	CAJA / BOX CARTON	P.V.P. € PRICE €
70083 00 00	1"	-	1	25,05

Ref. 70084

● Adaptador macho-macho para colectores 1"



Male-male adaptor, suitable for 1" manifolds

70084 04 04	1/2"x 1/2"	-	1	1,96
-------------	------------	---	---	------

Ref. 70090

● Accesorio con termómetro preinstalado



Fitting pre-assembled thermometer

70090 06 00	1"	-	1	20,61
-------------	----	---	---	-------

Ref. 4790

● Válvula motorizada / zona 2 vías con cable de 2 hilos



Construcción en latón. Extremos rosca gas hembra, ISO 228/1. Aplicación agua fría o caliente. Temperatura fluido < 94°C. Temperatura ambiente < 40°C. Tensiones 220V (±10%) 50-60 HZ. Presión nominal 16bar. Clase de protección IP 40. Palanca para accionamiento manual con muelle de retorno.

2 ways motorised-zone valve with 2 cores wire

Brass construction. Female threaded ends, ISO 228/1. Application: cold or hotwater. Fluid temp. < 94°C. Environment temp. < 40°C. Voltage 220V (±10%) 50-60 HZ. Nominal pressure 16bar. IP 40 protection class. Manual operating lever with spring return.

Recambio: art 4794 Motor para válvula motorizada art. 4790.
Spare parts: art. 4794 Motor for motorised-zone valve art. 4790

4790 04	1/2"	790	1-20	55,78
4790 05	3/4"	830	1-20	58,00
4790 06	1"	1020	1-20	66,92

Med.	C	E	F	G	H
4790 04	105,5	84	35,5	63	90
4790 05	105,5	84	35,5	63	93
4790 06	105,5	84	37	63	95

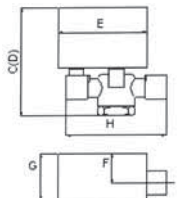

Ref. 4791

● Válvula motorizada / zona 3 vías con cable de 2 hilos



Construcción en latón. Extremos rosca gas hembra, ISO 228/1. Aplicación agua fría o caliente. Temperatura fluido < 94°C. Temperatura ambiente < 40°C. Tensiones 220V (±10%) 50-60 HZ. Presión nominal 16 bar. Clase de protección IP 40. Palanca para accionamiento manual con muelle de retorno.

3 ways motorised /zone valve with 2 cores wire

Brass construction. Female threaded ends, ISO 228/1. Application: cold or hotwater. Fluid temp. < 94°C. Environment temp. < 40°C. Voltage 220V (±10%) 50-60 HZ. Nominal pressure 16 bar. IP 40 protection class. Manual operating lever with spring return.

Recambio: art 4794 Motor para válvula motorizada art. 4791.
Spare parts: art. 4794 Motor for motorised-zone valve art. 4791

4791 04	1/2"	835	1-20	58,00
4791 05	3/4"	865	1-20	60,24
4791 06	1"	1045	1-20	71,38

Med.	C	E	F	G	H
4791 04	116	84	35,5	63	90
4791 05	119	84	35,5	63	93
4791 06	125	84	37	63	95

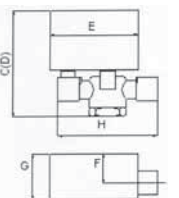

Ref. 4792



● **Válvula motorizada / zona 2 vías ON/OFF con muelle de retorno y con interruptor auxiliar y cable de 5 hilos**
 Construcción en latón. Extremos rosca gas hembra, ISO 228/1. Aplicación agua fría o caliente. Temperatura fluido < 94°C. Temperatura ambiente < 40°C. Tensiones 220V (±10%) 50-60 HZ. Presión nominal 16 bar. Clase de protección IP 40. Palanca para accionamiento manual con muelle de retorno.

2 ways motorised / zone ON/OFF valve with spring return and auxiliary switch and 5 cores wire
 Brass construction. Female threaded ends, ISO 228/1. Application: cold or hotwater. Fluid temp. < 94°C. Environment temp. < 40°C. Voltage 220V (±10%) 50-60 HZ. Nominal pressure 16 bar. IP 40 protection class. Manual operating lever with spring return.

CÓDIGO CODE	MEDIDA SIZE	PESO WEIGHT	CAJA / BOX CARTON	P.V.P. € PRICE €
4792 04	1/2"	900	1-20	63,21
4792 05	3/4"	930	1-20	65,43
4792 06	1"	1110	1-20	74,35

Med.	C	E	F	G	H
4792 04	105	84	35,5	63	90
4792 05	105,5	84	35,5	63	93
4792 06	109,5	84	37	63	95

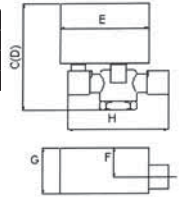

Ref. 4793



● **Válvula motorizada / zona 3 vías ON/OFF con muelle de retorno y con interruptor auxiliar y cable de 5 hilos**
 Construcción en latón. Extremos rosca gas hembra, ISO 228/1. Aplicación agua fría o caliente. Temperatura fluido < 94°C. Temperatura ambiente < 40°C. Tensiones 220V (±10%) 50-60 HZ. Presión nominal 16 bar. Clase de protección IP 40. Palanca para accionamiento manual con muelle de retorno.

3 ways motorised / zone ON/OFF valve with spring return and auxiliary switch and 5 cores wire
 Brass construction. Female threaded ends, ISO 228/1. Application: cold or hotwater. Fluid temp. < 94°C. Environment temp. < 40°C. Voltage 220V (±10%) 50-60 HZ. Nominal pressure 16 bar. IP 40 protection class. Manual operating lever with spring return.

4793 04	1/2"	985	1-20	65,43
4793 05	3/4"	985	1-20	67,67
4793 06	1"	1130	1-20	78,81

Med.	C	E	F	G	H
4793 04	116	84	35,5	63	90
4793 05	119	84	35,5	63	93
4793 06	125	84	37	63	95

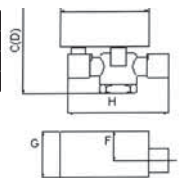

Ref. 3911



● **Termostato de pared electromecánico**
 Alimentación: 2 hilos a 230VAC. Diferencial térmico: ±0,8°C. Rango temperatura regulación: 10°C-30°C. Dimensiones: 75x75x25 mm.

Wall electromechanical thermostat
 Power supply: 2 wires to 230VAC. Differential: ±0,8°C. Setting temperature range: 10°C-30°C. Dimensions: 75x75x25 mm.

3911 00	-	75	1	15,91
---------	---	----	---	-------

Ref. 3912



● **Termostato de pared electrónico con display**
 Alimentación: 2 baterías 1,5V, tipo AAA. Rango temperatura de regulación: 5°C-35°C. Diferencial térmico: ±0,3°C. Indicador de batería baja. Dimensiones: 86x86x23 mm.

Wall electronic thermostat with display
 Power supply: 2 batteries 1,5V, AAA type. Setting temperature range: 5°C- 35°C. Differential: ±0,3°C. Low battery indication. Dimensions: 86x86x23mm.

3912 00	-	75	1	37,78
---------	---	----	---	-------

CÓDIGO CODE	MEDIDA SIZE	PESO WEIGHT	CAJA / BOX CARTON	P.V.P. € PRICE €
3913 00	-	120	1	86,67

Ref. 3913



Cronotermostato de pared y semiempotrado

Alimentación: 2 baterías 1,5 V, tipo AA. Control del nivel de batería con dos niveles de aviso. Fácil sustitución de las baterías sin pérdida de datos. Instalación semiempotrada en caja o sobre pared. Programación diaria y semanal con rango de 0,5°C. Diferencial térmico: ±0,3°C. Rango temperatura: 5°C-30°C. Mínimo intervalo de ajuste: 1 hora. Pantalla gráfica. Dimensiones: montaje a pared 138x86x23 mm. Montaje semiempotrado 119x82x20 mm.

Wall and semirecessed chronothermostat

Power supply: 2 batteries 1,5 V, AA type. Battery automatic control with 2 warnings levels. Easy battery replacement without data loss. Installation semirecessed with box or on the wall. Daily and weekly programming with range of 0,5°C. Differential: ±0,3°C. Temperature range: 5°C-30°C. Minimum setting interval: 1 hour. Graphic display. Dimensions: wall mounting 138x86x23 mm.

3914 00	-	110	1	104,38
---------	---	-----	---	--------

Ref. 3914



Termostato de pared digital con pantalla táctil

Doble modo de funcionamiento (aire acondicionado/ calefacción). Rango temperatura invierno: 5°C-30°C. Rango temperatura verano: 15°C a 35°C. Alimentación 2 baterías AAA 1,5 V. Indicador de batería baja. Programa anti-hielo. Conexión eléctrica al dispositivo 220Vca-5A. Dimensiones: 115x 83x21 mm.

Touch screen wall digital thermostat

Dual mode operation (air conditioning/ heating). Winter temperature range: 5°C-30°C. Summer temperature range: 15°C-35°C. Power supply: 2 batteries 1,5 V, AAA type. Low battery indicator. With defrosting programme. Electrical connection with device 220Vca-5A. Dimensions: 115x 83x21 mm.

3900 00	-	151	1-50	42,93
---------	---	-----	------	-------

Ref. 3900



Termostato electrónico oscilante / modular con pantalla LCD (empotrar)

Alimentación: 24 VAC. Consumo: 5 VA (sin carga) Precisión: ±0,5°C. Rango de control: 10°C-30°C. Temperatura de trabajo: 0-55°C. Humedad ambiente máxima: 90%HR. Dimensiones: 93 x 113 x 27

Electronic floating/ modulating thermostat with LCD display (built-in)

Power supply: 24 VAC. Consumption: 5VA (without load) Precision: ±0,5°C. Control range: 10°C-30°C Working temperature: 0-55°C. Maximum environment humidity: 90% RH Dimensions: 93 x 113 x 27

3901 00	-	105	1-50	31,90
---------	---	-----	------	-------

Ref. 3901



Termostato electrónico ON/OFF con display fondo color (de empotrar)

Alimentación: 220-230 VAC. Consumo: 6VA (sin carga). Precisión: ±0,5°C. Rango control: 10°C-30°C. Temperatura de trabajo: 0-55°C. Humedad ambiente máxima: 90% HR. Dimensiones: 86 x 86 x 33

Electronic ON/OFF thermostat with colour back light display (built-in)

Power supply: 220-230 VAC. Consumption: 6VA (without load). Precision: ±0,5°C. Control range: 10°C-30°C. Working temperature: 0-55°C. Maximum environment humidity: 90% RH. Dimensions: 86 x 86 x 33

3902 00	-	151	1-50	38,98
---------	---	-----	------	-------

Ref. 3902



Termostato electrónico ON/OFF con pantalla LCD (de empotrar)

Alimentación: 220-230VAC. Consumo: 5VA (sin carga). Precisión: ±0,5°C. Rango control: 10°C-30°C. Temperatura de trabajo: 0-55°C. Máxima humedad ambiente: 90%. Dimensiones: 93 x 113 x 26

Electronic ON/OFF thermostat with LCD display (built-in)

Power supply: 220-230 VAC. Consumption: 5VA (without load). Precision: ±0,5°C. Control range: 10°C-30°C. Working temperature: 0-55°C. Maximum environment humidity: 90%. Dimensions: 93 x 113 x 26

Ref. 3905



● **Termostato electrónico oscilante/ modular con selector (de empotrar)**
 Alimentación: 24VAC. Consumo: 2VA (sin carga). Precisión: $\pm 1^{\circ}\text{C}$.
 Rango control: 10°C - 30°C . Temperatura de trabajo: 0 - 55°C .
 Máxima humedad ambiente: 90%.
 Dimensiones: 87 x 132 x 41

Electronic floating/ modulating thermostat with switching system (built-in)

Power supply: 220-230 VAC. Consumption: 2VA (without load). Precision: $\pm 1^{\circ}\text{C}$. Control range: 10°C - 30°C . Working temperature: 0 - 55°C . Maximum environment humidity: 90%. Dimensions: 87 x 132 x 41

CÓDIGO CODE	MEDIDA SIZE	PESO WEIGHT	CAJA / BOX CARTON	P.V.P. € PRICE €
3905 00	-	165	1-50	40,15

Ref. 3906



● **Termostato electrónico oscilante / modular con pantalla LCD (de empotrar)**
 Alimentación: 24VAC. Consumo: 5VA (sin carga). Precisión: $\pm 0,5^{\circ}\text{C}$.
 Rango control: 10°C - 30°C . Temperatura de trabajo: 0 - 55°C .
 Máxima humedad ambiente: 90%.
 Dimensiones: 93 x 113 x 26

Electronic floating/ modulating thermostat with LCD display (built-in)

Power supply: 24 VAC. Consumption: 5VA (without load). Precision: $\pm 0,5^{\circ}\text{C}$. Control range: 10°C - 30°C . Working temperature: 0 - 55°C . Maximum environment humidity: 90%. Dimensions: 93 x 113 x 26

3906 00	-	144	1-50	44,61
---------	---	-----	------	-------

Ref. 3255



NOVEDAD NEW

● **Bomba de condensación**
 Sistema compuesto de una unidad de bomba y de una unidad de detección para evacuar los condensados en unidades de aire acondicionado, de refrigeración y en las calderas de condensación. Voltaje 230V 50/60 Hz. Instalación Externa. Caudales 12 L/h o 36L/h. Temp. ambiente 0°C + 50°C .

Condensate pump

It is a system which consists of a pump unit and detection unit allowing condensates to be evacuated in air conditioning, refrigeration and condensing boiler units. External Installation. Voltage 230V 50/60 Hz. Flow rate 12 L/h or 36 L/h. Ambient Temp: 0°C + 50°C .

3255 12L	12 L	-	1	85,34
3255 36L	36 L	-	1	93,28

Ref. 3256



NOVEDAD NEW

● **Bomba de condensación mini**
 Sistema compuesto de una unidad de bomba y de una unidad de detección para evacuar los condensados en unidades de aire acondicionado, de refrigeración y en las calderas de condensación. Voltaje 230V 50/60 Hz. Instalación interna. Caudales 12 L/h o 36 L/h. Temp. ambiente 0°C + 50°C .

Mini condensate pump

It is a system which consists of a pump unit and detection unit allowing condensates to be evacuated in air conditioning, refrigeration and condensing boiler units. Internal Installation. Voltage 230V 50/60 Hz. Flow rate 12 L/h or 36 L/h. Ambient Temp: 0°C + 50°C .

3256 12L	12 L	-	1	99,25
3256 36L	36 L	-	1	142,88

Ref. 70500



NOVEDAD NEW

● **Mando universal aire acondicionado.**

A/C universal remote control

70500	-	-	1	14,71
-------	---	---	---	-------

ENERGÍA SOLAR TÉRMICA / THERMAL SOLAR ENERGY

La "energía solar térmica" es una tecnología que convierte la luz solar en calor que puede después ser usado para calentar agua para uso doméstico y para el sistema de calefacción.

Existen diferentes tipos de sistemas solares empleados para el calentamiento de agua sanitaria y/o la propia calefacción, entre los cuales destacan por ser los más utilizados los sistemas de circulación natural, los sistemas de circulación forzada y los sistemas combinados.

Para todos los tipos existentes se requiere de una serie de elementos para su instalación, de los cuales Genebre pone a su disposición una amplia gama de ellos, que se irá ampliando según las necesidades de nuestros clientes e instaladores.

The "solar thermal" is a technology that converts sunlight into heat that can then be used to heat domestic water and heating system.

There are different types of solar systems used only for the heating of sanitary water or either for the heating itself, among which stand out as being the most widely used natural circulation systems, forced circulation systems and combined systems.

For all existing types requires a number of elements to be installed, of which Genebre offers a wide range of them, which will be expanded according to the needs of our customers and installers.

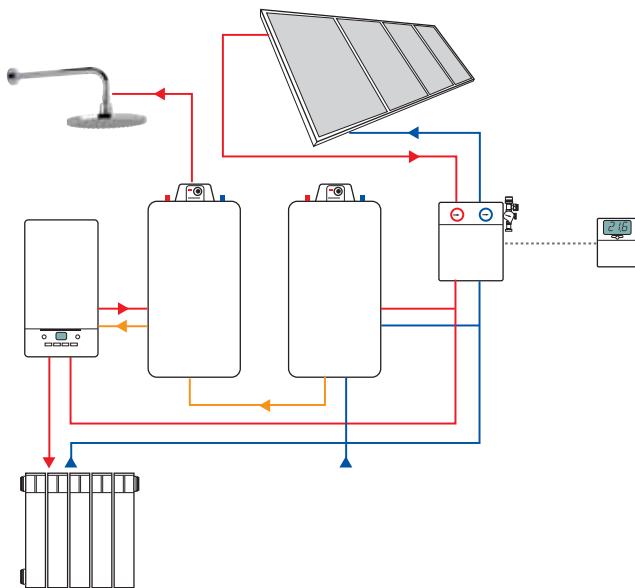

Instalación básica / Basic installation

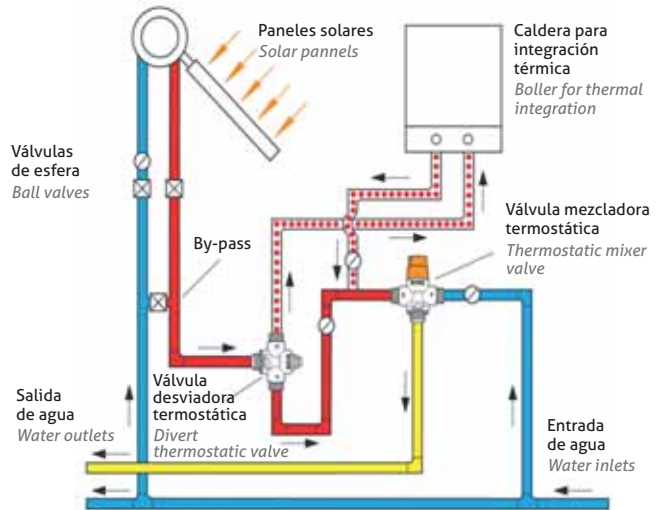

Esquema kit termostático / Thermostatic kit installation

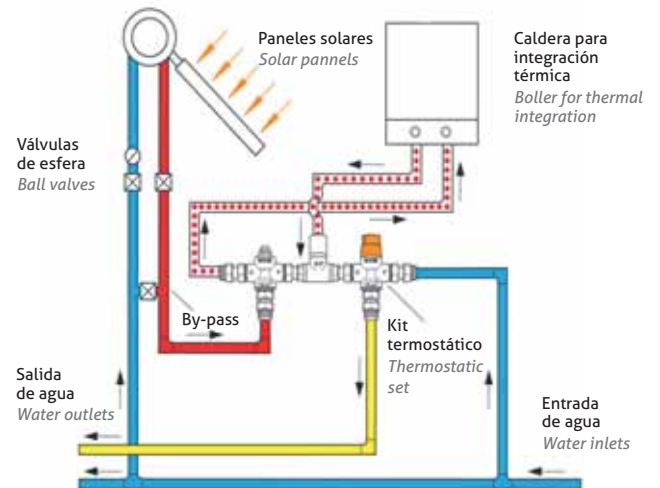

Ref. 3134

● **Válvula de esfera**

PN 25. Paso total. Construcción en latón UNE-EN 12165 cromado. Juntas PTFE. Extremos rosca gas M-H, ISO 228/1. Temp. máx. 160°C. Mando manual por palanca acero.

Ball valve

PN 25. Full bore. Body chrome plated brass UNE-EN 12165. Seats PTFE. Gas threaded ends M-F, ISO 228/1. Max. temp. 160°C. Manual control lever steel handle.



R	P	A	L	M
1/2"	15	47	55	84
3/4"	20	58	64	98
1"	25	61	76	98
1 1/4"	32	74	87	126
1 1/2"	40	80	95	126
2"	50	81	109	126

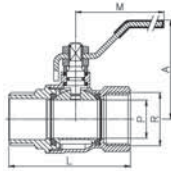

CÓDIGO CODE	MEDIDA SIZE	PESO WEIGHT	CAJA / BOX CARTON	P.V.P. € PRICE €
3134 04	1/2"	160	8-192	4,03
3134 05	3/4"	270	6-108	6,59
3134 06	1"	410	6-72	9,79
3134 07	1 1/4"	650	4-48	15,14
3134 08	1 1/2"	875	2-24	22,24
3134 09	2"	1370	2-18	23,62

Ref. 3136

● **Válvula de esfera**

PN 25. Paso total. Construcción en latón UNE-EN 12165 cromado. Juntas PTFE. Extremos rosca gas M-H, ISO 228/1. Temp. máx. 160°C. Mando manual por palomilla acero.

Ball valve

PN 25. Full bore. Body chrome plated brass UNE-EN 12165. Seats PTFE. Gas threaded ends M-F, ISO 228/1. Max. temp. 160°C. Manual control lever steel handle.



R	P	A	L	M
3/8"	10	38	49	50
1/2"	15	40	56	50
3/4"	20	50	64	62
1"	25	53	76	62

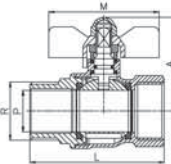

3136 03	3/8"	105	12-288	3,27
3136 04	1/2"	145	10-240	4,04
3136 05	3/4"	240	6-108	6,41
3136 06	1"	380	5-90	9,71

Ref. 70037

● **Purgador automático de aire**

Cuerpo en latón niquelado. Extremo rosca macho ISO 228/1. Temperatura máxima de trabajo 160°C. Presión máxima de trabajo: 10 bar.

Automatic air vent

Body brass nickel-plated. Male thread ISO 228/1. Maximum working temperature 160°C. Maximum working pressure: 10 bar.



R	A	D	H
G3/8"	79	50	64

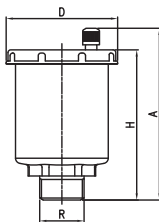

70037 03 00	3/8"	183	10-80	8,15
-------------	------	-----	-------	------

Ref. 3178

● **Válvula de seguridad escuadra**

Cuerpo en latón. Extremos rosca hembra ISO 228/1. Temperatura máxima de trabajo 160°C. Taraje 6 bar.

Safety relief angle valve

Body in brass. Female threaded ends ISO 228/1. Maximum working temperature 160°C. 6 bar setting pressure.



H	A
76	31



3178 04	1/2"x3/4"	260	10-100	12,99
---------	-----------	-----	--------	-------

Ref. 3144



Válvula de descarga para caldera
 PN 25. Paso total. Construcción en latón UNE-EN 12165 cromado. Asientos PTFE. Extremos rosca gas (BSP) M ISO 228/1 y conexión a manguera Ø15 con tapón seguridad. Temp. máx. 160°C. Mando manual por palomilla aluminio.

Boiler discharge valve
 PN 25. Full bore. Body brass UNE-EN 12165. PTFE seats. Threaded end male ISO 228/1 and Ø15 hose connection with safety cap. Max. Temp. 160°C. Aluminium butterfly handle.

R	DN	H	L	M
G 1/2" x Ø15	10	34	72	35,5

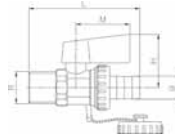

CÓDIGO CODE	MEDIDA SIZE	PESO WEIGHT	CAJA / BOX CARTON	P.V.P. € PRICE €
3144 04	1/2" x Ø15	145	8-192	-

Ref. 2444



Válvula retención "Cromax" - "Idrja" para solar
 Construcción: AISI 304 -asiento vitón. Cierre de teflón. Extremos roscados DIN 2999. Temp. de trabajo, mín. -25°C -máx. +150°C. Presión de trabajo, 16 bar. Presión de apertura, 0,03 bar.

"Cromax" check valve "Idrja" for solar energy
 Constr.: AISI 304 - viton seat. PTFE sealing. Gas threaded ends DIN 2999. Working temp. min. -25°C + 150°C. Working pressure: 16 bar. Opening pressure: 0.03 bar.

DN	R	B	C
15	1/2"	32	54
20	3/4"	44	68
25	1"	53	83
32	1 1/4"	62	102

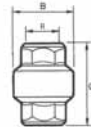

2444 04	1/2"	0,088	12-288	18,41
2444 05	3/4"	0,142	8-104	21,94
2444 06	1"	0,167	8-80	25,78
2444 07	1 1/4"	0,270	6-48	34,15

Ref. 14315



Mezclador termostático vertical para paneles solares
 Posibilidad de bloqueo del volante tras regulación. Temperatura máxima de entrada de agua 110°C y posibilidad de regulación de 30°C a 65°C. Aplicación para paneles solares.

Vertical thermostatic mixing valve for solar installation
 Possibility to block the handle position after the adjusting of the temperature. Maximum temperature inlet 110°C and possibility of adjustment from 30°C to 65°C. For solar panels application.

a	b
63	44

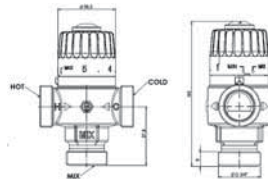

14315 05	3/4"	340	1	60,34
----------	------	-----	---	-------

Ref. 1431U



Mezclador termostático vertical universal
 Dispositivo para regular temperatura con bloqueo del suministro según EN 1111. Cartucho extraíble y unidad termostática especial con protección anticál y alta velocidad de respuesta. Posibilidad de bloqueo del volante tras la regulación. Temperatura máxima de entrada agua 110°C y posibilidad de regulación de 25°C a 65°C. Aplicación en todos los sistemas sanitarios.

Universal vertical thermostatic mixing valve
 Anti-scalding device with stop water supply EN 1111. Extractable cartridge and thermostatic special unit with lime protection and high-speed response. Possibility to block the handle position after the adjusting of the temperature. Maximum temperature inlet 110°C and possibility of adjustment from 25°C to 65°C. For all of the sanitary systems application.

1431U 05	3/4"	396	1	70,08
----------	------	-----	---	-------

a	b
63	42

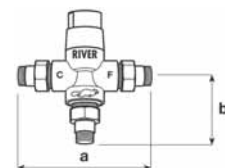

NOVEDAD
NEW

Ref. 1444



Mezclador termostático vertical con termómetro

Dispositivo para regular temperatura con bloqueo del suministro según EN 1111. Cartucho extraíble y unidad termostática especial con protección anticál y alta velocidad de respuesta. Posibilidad de bloqueo del volante tras la regulación. Temperatura máxima de entrada agua 110°C. Termómetro de inmersión incorporado. Con filtro de acero inoxidable, válvula de retención y rácores incorporados. Aplicación para paneles solares.

Vertical thermostatic mixing valve with thermometer

Anti-scalding device with stop water supply S/EN 1111. Extractable cartridge and thermostatic special unit with lime protection and high-speed response. Possibility to block the handle position after the adjusting of the temperature. Maximum temperature inlet 110°C. Immersion thermometer incorporated. With stainless steel filter, check valve and tangs incorporated. For solar panels application.

CÓDIGO CODE	MEDIDA SIZE	PESO WEIGHT	CAJA / BOX CARTON	P.V.P. € PRICE €
1444 04	1/2"	1105	1	155,87
1444 05	3/4"	1170	1	155,87

a	b
165	120

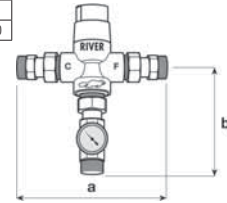

Ref. 1452



Válvula desviadora termostática

Desvía automáticamente el agua caliente que proviene del panel a la caldera, sólo cuando es necesario integrar la temperatura. Elemento termostático con protección anticál y alta velocidad de respuesta. Temperatura máxima de entrada agua 110°C. Válvula tarada a 40°C.

Divert thermostatic valve

Divert automatically the hot water coming from the panel to the boiler only when it is necessary integrate the temperature. Thermostatic unit with lime protection and high-speed response. Maximum temperature inlet 110°C. Setting temperature 40°C.

1452 05	3/4"	635	1	92,47
---------	------	-----	---	-------

a	b
90	44

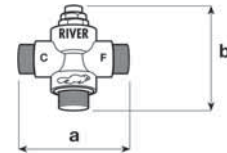

Ref. 1451



Kit termostático con válvula desviadora y mezclador

Kit termostático premontado antiescaldo para facilitar la conexión desde el panel solar hasta la caldera y una válvula desviadora termostática. Mezclador con temperatura máxima de entrada 110°C, filtro de inoxidable, válvula de retención y rácores. Válvula desviadora termostática con temperatura preestablecida de 40°C.

Thermostatic kit with divert valve and mixer

Anti-scalding connected thermostatic kit for facilitate connection from the solar panel to the boiler. Mainly composed of a vertical thermostatic mixer and a divert thermostatic valve. Mixer with stainless steel filter, check valve and tangs with maximum water inlet temperature 110°C. Divert thermostatic valve with setting temperature 40°C.

1451 05	3/4"	2150	1	277,85
---------	------	------	---	--------

a	b	c
198	360	180

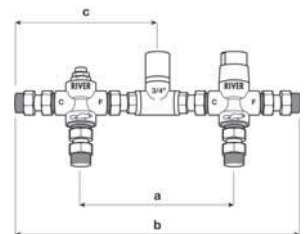

ENERGÍA SOLAR TÉRMICA

Sistema de apriete fitting para tubo flexible

THERMAL SOLAR PLANTS

Flange forming harmer system for flexible pipe fittings



Ref. 0585
Martillo de apriete.
Flange forming hammer.

Ref. 0500

- **Kit de conexión**
Kit de 4 unidades. Tuercas en latón y anillos metálicos en acero inox.

0500 04	DN12	120	1-75	9,24
0500 05	DN16	140	1-60	12,01
0500 06	DN20	240	1-50	19,47



Connection kit
4 units kit. Brass nuts and stainless steel metal clips.

Ref. 0505

- **Racor tubo cobre**
Construcción en latón. Conexión tubo cobre con anillo compresión. Rosca macho con asiento plano para conexión tubo corrugado inox.

0505 04 15	1/2" x Ø15	65	10-150	4,36
0505 04 18	1/2" x Ø18	95	10-150	5,30
0505 04 22	1/2" x Ø22	100	10-100	6,52
0505 05 15	3/4" x Ø15	100	10-150	5,95
0505 05 18	3/4" x Ø18	105	10-150	5,98
0505 05 22	3/4" x Ø22	110	10-100	6,70
0505 06 22	1" x Ø22	160	10-100	8,33



Cooper pipe fitting
Brass construction. Copper pipe connection with compression ring. Male thread with flat seat for corrugated s/s. pipe.

Ref. 0525

- **Machón**
Construcción en latón. Roscas macho con asiento plano para conexión tubo corrugado inox.

0525 04 04	1/2" x 1/2"	50	10-250	3,07
0525 04 05	1/2" x 3/4"	65	10-200	4,77
0525 05 05	3/4" x 3/4"	85	10-200	4,66
0525 05 06	3/4" x 1"	115	10-100	6,93
0525 06 06	1" x 1"	140	10-100	6,63



Nipple
Brass construction. Male threads with flat seat for corrugated s/s. pipe.

ENERGÍA SOLAR TÉRMICA

THERMAL SOLAR PLANTS

Sistema de apriete con fitting de rápido ensamblaje

Quick assembling fitting flange forming system



Ref. 0550

● **Racor Acoplamiento**

Construcción en latón. Acoplamiento para conexión tubo corrugado.

Coupling Fitting

Brass construction. Corrugated pipe coupling connection.



0550 16	DN16	215	4	24,72
0550 20	DN20	290	4	35,84
0550 25	DN25	400	4	64,11

Ref. 0560

● **Racor Conexión Soldar**

Construcción en latón. Acoplamiento para conexión tubo corrugado. Extremo para soldar.

Welding Connection Fitting

Brass construction. Corrugated pipe coupling connection. Welding connection.



0560 16 15	DN16 x Ø15	155	1	15,53
0560 16 18	DN16 x Ø18	145	1	16,67
0560 16 22	DN16 x Ø22	145	1	16,67
0560 20 15	DN20 x Ø15	-	1	22,49
0560 20 18	DN20 x Ø18	195	1	24,25
0560 20 22	DN20 x Ø22	195	1	24,15
0560 25 18	DN25 x Ø18	-	1	43,18
0560 25 22	DN25 x Ø22	280	1	43,18

Ref. 0565

● **Racor Conexión Rosca Macho**

Construcción en latón. Acoplamiento para conexión tubo corrugado. Extremo rosca macho.

Male Thread Connection Fitting

Brass construction. Corrugated pipe coupling connection. Male thread connection.



0565 16 05	DN16 x 3/4"	150	1	16,43
0565 20 05	DN20 x 3/4"	200	1	22,54
0565 20 06	DN20 x 1"	220	1	23,48

Ref. 0570

● **Racor Conexión Rosca Hembra**

Construcción en latón. Acoplamiento para conexión tubo corrugado. Extremo rosca hembra.

Female Thread Connection Fitting

Brass construction. Corrugated pipe coupling connection. Female thread connection.



0570 16 05	DN16 x 3/4"	140	1	16,00
0570 20 05	DN20 x 3/4"	160	1	21,92
0570 20 06	DN20 x 1"	195	1	23,25

Ref. 0575



Tubo corrugado flexible con aislamiento
 Doble tubo en acero inoxidable AISI 316L con recubrimiento EPDM. Protección exterior en POLIOLEFINE, resistente UV. Cable sonda aislado en silicona. Aislamiento s/ ASTM D 635 -ASTM C 177.

Corrugated flexible pipe with isolation
 Stainless steel AISI 316L twin pipe with EPDM covering. Outer protective sleeve in POLIOLEFINE, UV-resistant. Silicon insulated probe wire. Isolation acc. to ASTM D 635 -ASTM C 177.

CÓDIGO CODE	MEDIDA SIZE	PESO WEIGHT	CAJA / BOX CARTON	P.V.P. € PRICE €
0575 12	DN12	-	1	8,14 ²
0575 16	DN16	-	1	7,84 ²
0575 20	DN20	-	1	10,30 ²
0575 25	DN25	-	1	14,28 ²

²Precios por metro. Compra mínima 15 m. / Prices for a meter. Minimum order 15 m.

Ref. 0580



Tubo corrugado flexible
 Construcción en acero inoxidable.

Corrugated flexible pipe
 Stainless steel construction.

0580 12	-	-	-	-
0580 16	-	-	-	-
0580 20	-	-	-	-
0580 25	-	-	-	-

Precios a consultar / Prices on request



3

VÁLVULAS DE GAS GAS VALVES

Válvulas de gas con certificación AENOR para el mercado español, diseñadas según normas UNE-EN 331 y UNE 60718. Y otras válvulas de gas para mercados internacionales.

Gas valves with AENOR certification for the Spanish market, designed according to UNE-EN 331 and UNE 60718 standards, as well as other gas valves for the International markets.



Las válvulas de gas de Genebre están diseñadas según normas UNE- EN 331 y UNE 60718.

Estas válvulas están destinadas a instalaciones domésticas y comerciales que no se encuentran enterradas directamente en el interior o exterior de edificios, y que emplean gases de la primera, segunda y tercera familia, según la norma EN 437.

CARACTERÍSTICAS DE LAS VÁLVULAS

- Construcción en latón UNE-EN 12164-12165
- Juntas en NBR según EN 549
- Extremos roscados gas (BSP) según ISO 228/1
- Eje con doble junta tórica
- Accionamientos precintables
- Sellado de cuerpo y tapa mediante adhesivo y junta tórica
- Temperatura de servicio desde -40°C a 60°C
- Sistema de bloqueo en posición de cierre
- Presión de trabajo 5 bar (MOP 5)
- Garantizada para el uso de Gas Natural

Genebre's gas valves are designed according standards UNE-EN 331 and UNE 60718.

They are used for domestic and commercial not buried installations inside or outside of buildings, using gases of the first, second and third family according EN 437.

VALVES CHARACTERISTICS

- Brass construction UNE-EN 12164-12165
- NBR joint following EN 549
- Gas (BSP) threaded ends according ISO 228/1
- Stem with double o'ring
- Sealeable handles
- Body and cap sealed by means adhesive and o-ring
- Service temperature from -40°C to 60°C
- Locking system at closed position
- Working pressure 5 bar (MOP 5)
- Guaranteed for the use of Natural Gas

1. Cuerpo / Body
2. Asientos / Ball seats
3. Esfera / Ball
4. Junta tórica / O'ring
5. Tapa / Cap
6. Eje / Stem
7. Junta tórica / O'ring
8. Tuerca / Nut
9. Accionamiento / Handle

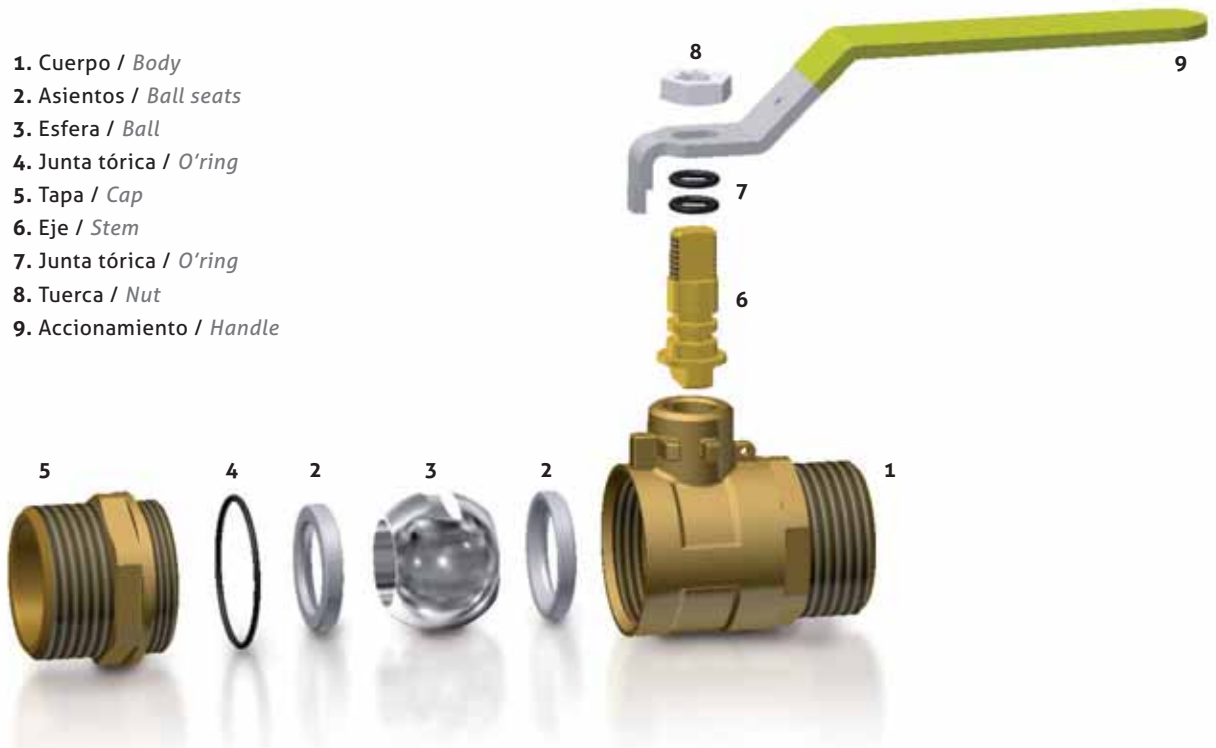

Producto certificado AENOR
AENOR certificated product



Ref. 3610

● **Válvula recta para gas, M-M**
Mando palanca de acero galvanizado precintable.

Straight valve for gas, M-M
Sealable galvanized steel lever handle.



R	P	L	A	M	t
1/2"	10	56	46	84	10
3/4"	15	65	48	84	13
1"	20	75	58	98	15
1 1/4"	25	87	62	98	19
1 1/2"	32	101	74	125	21
2"	40	124	80	125	27

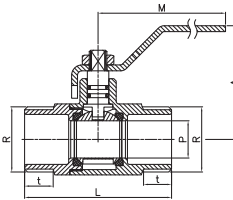

CÓDIGO CODE	MEDIDA SIZE	PESO WEIGHT	CAJA / BOX CARTON	P.V.P. € PRICE €
3610 04	1/2"	160	8-144	7,45
3610 05	3/4"	235	8-96	7,62
3610 06	1"	385	6-72	12,00
3610 07	1 1/4"	595	4-48	19,35
3610 08	1 1/2"	865	2-24	33,38
3610 09	2"	1430	2-18	57,51



Ref. 3615

● **Válvula recta para gas, M-M**
Mando palomilla de aluminio precintable.

Straight valve for gas, M-M
Sealable aluminium butterfly handle.



R	P	L	A	M	t
1/2"	10	56	35	50	10
3/4"	15	65	37	50	13
1"	20	75	45	62	15
1 1/4"	25	87	49	62	19

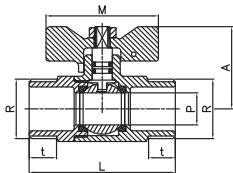

3615 04	1/2"	140	10-180	6,47
3615 05	3/4"	215	6-108	7,62
3615 06	1"	350	5-90	12,08
3615 07	1 1/4"	550	4-48	19,62



Ref. 3620

● **Válvula recta para gas, M-H tuerca deslizante**
Mando palanca de acero galvanizado precintable.

Straight valve for gas, M-F sliding nut
Sealable galvanized steel lever handle.



R	P	L	A	M	t
3/4"	15	70	48	84	13
7/8"	20	75	58	98	15
1 1/4"	25	100	62	98	19

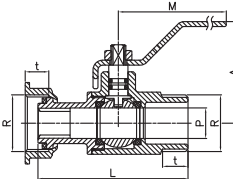

3620 05	3/4"	270	6-108	10,57
3620 78	7/8"	425	6-72	11,57
3620 07	1 1/4"	675	2-24	26,79



Ref. 3622

● **Válvula recta para gas, M-H tuerca deslizante**
Mando palomilla de aluminio precintable.

Straight valve for gas, M-F sliding nut
Sealable aluminium butterfly handle.



R	P	L	A	M	t
3/4"	15	70	37	50	13
7/8"	20	75	45	62	15
1 1/4"	25	100	49	62	19

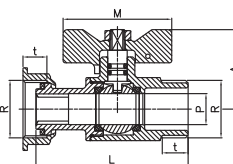

3622 05	3/4"	250	5-90	10,29
3622 78	7/8"	390	5-90	11,40
3622 07	1 1/4"	640	4-48	25,38



Ref. 3625

● **Válvula escuadra para gas, M-H tuerca deslizante**
Mando palanca de acero galvanizado.

Angle valve for gas, M-F sliding nut
Sealable galvanized steel lever handle.



R	P	L	A	M	t
3/4"	14	38	48	84	12
7/8"	17	39	58	98	12
1 1/4"	25	59	62	98	16

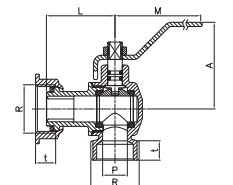

3625 05	3/4"	245	6-72	11,19
3625 78	7/8"	395	6-72	11,82
3625 07	1 1/4"	660	2-24	30,19



Ref. 3627

● Válvula escuadra para gas, M-H tuerca deslizante
Mando palomilla de aluminio precintable.

*Angle valve for gas, M-F sliding nut
Sealable aluminium butterfly handle.*



R	P	L	A	M	t
3/4"	15	70	37	50	13
7/8"	20	75	45	62	15
1 1/4"	25	100	49	62	19

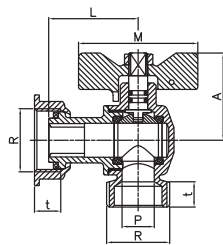

CÓDIGO CODE	MEDIDA SIZE	PESO WEIGHT	CAJA / BOX CARTON	P.V.P. € PRICE €
3627 05	3/4"	225	5-90	11,19
3627 78	7/8"	360	5-90	11,82
3627 07	1 1/4"	625	4-48	30,19

Ref. 3630

● Válvula recta para gas, M-M con patas
Mando palanca de acero galvanizada precintable.

*Straight valve for gas, M-M with feet
Sealable galvanized steel lever handle.*



R	P	L	A	M	t
1/2"	10	56	46	84	10
3/4"	15	65	48	84	13

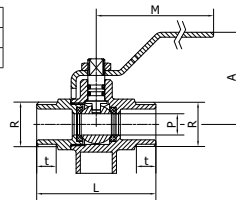

3630 04	1/2"	188	8-144	9,88
3630 05	3/4"	258	8-96	13,60

Ref. 3632

● Válvula recta para gas, M-M con patas
Mando palomilla de acero galvanizada precintable.

*Straight valve for gas, M-M with feet
Sealable galvanized steel butterfly handle.*



R	P	L	A	M	t
1/2"	10	56	35	50	10
3/4"	15	65	37	50	13

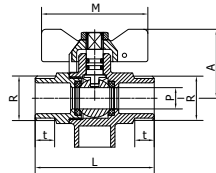

3632 04	1/2"	171	10-180	9,22
3632 05	3/4"	236	6-108	12,94

Ref. 3600

● Válvula para gas con autobloqueo, M-M
Mando precintable en zamak. Accionamiento con muelle de seguridad. Acabado superficial cromado.

*Gas valve with autolock, M-M
Zamak sealable handle. Manual control with safety spring.
Chrome-plated surface finishing.*



R	P	A	L	M
1/2"	9	55	32	51
M20x150	9	55	32	51

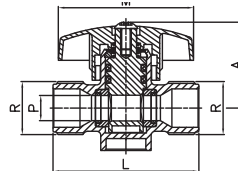

3600 04	1/2"	162	4-48	5,73
3600 20	M20x150	162	4-48	6,04
3600 05	3/4"	-	-	12,94

Ref. 3650

● Purgador de gas para soldar
Construcción en latón

*Trap welding
Construction: Brass*



Ref.	ØA	ØB	ØC	D
3650 012	14	8,25	12	24
3650 015	16	8,2	15	23

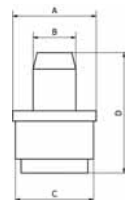

3650 012	D. 12 mm	12	-	-
3650 015	D. 15 mm	20	-	-

Ref. 3500



● **Válvula recta para gas, H-H**
Acabado superficial cromado.
Mando palanca acero cromado precintable.

Gas straight valve, F-F
Chrome-plated surface finishing.
Sealable chrome-plated steel lever handle.

R	DN	L	A	M	t
1/2"	15	58	47	83	15,5
3/4"	20	65	58	97	16,5
1"	25	78	60,5	97	19,5
1 1/4"	32	88	74	125	20

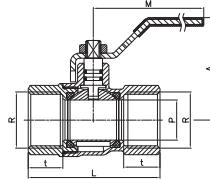

CÓDIGO CODE	MEDIDA SIZE	PESO WEIGHT	CAJA / BOX CARTON	P.V.P. € PRICE €
3500 04	1/2"	190	10-140	5,99
3500 05	3/4"	310	8-96	9,53
3500 06	1"	460	6-60	14,37
3500 07	1 1/4"	725	6-36	22,57

Ref. 3505



● **Válvula recta para gas, H-H**
Acabado superficial cromado.
Mando palomilla aluminio precintable.

Gas straight valve, F-F
Chrome-plated surface finishing.
Sealable aluminium butterfly handle.

R	DN	L	A	M	t
1/2"	15	58	35,5	50	15,5
3/4"	20	65	44,5	62	16,5
1"	25	78	47	62	19,5

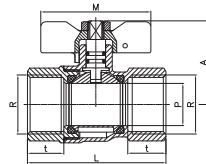

3505 04	1/2"	170	10-140	5,65
3505 05	3/4"	275	8-96	9,17
3505 06	1"	425	6-60	14,35

Ref. 3510



● **Válvula recta para gas, M-H**
Acabado superficial cromado. Mando palanca acero cromado.

Gas straight valve, M-F
Chrome-plated surface finishing.
Sealable chrome-plated steel lever.

R	DN	L	A	M	t	t1
1/2"	15	62,5	47	83	15,5	13,5
3/4"	20	69	58	97	16,5	14,5
1"	25	82,5	60,5	97	19,5	17,5
1 1/4"	32	91,5	74	125	20	19,5

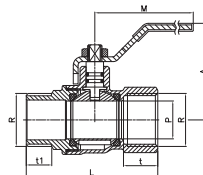

3510 04	1/2"	190	10-140	6,04
3510 05	3/4"	310	8-80	9,76
3510 06	1"	455	6-60	15,26
3510 07	1 1/4"	705	6-36	23,15

Ref. 3515



● **Válvula recta para gas, M-H**
Acabado superficial cromado. Mando palomilla aluminio precintable.

Gas straight valve, M-F
Chrome-plated surface finishing.
Sealable aluminium butterfly handle.

R	DN	L	A	M	t	t1
1/2"	15	62,5	35,5	50	15,5	13,5
3/4"	20	69	44,5	62	16,5	14,5
1"	25	82,5	47	62	19,5	17,5

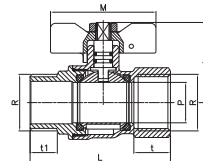

3515 04	1/2"	165	10-140	5,98
3515 05	3/4"	275	8-80	10,02
3515 06	1"	420	6-60	15,27

Ref. 3520



● **Válvula recta para gas, H-conexión manguera**
Acabado superficial cromado. Mando palomilla aluminio precintable.

Gas straight valve, F-hose connection
Chrome-plated surface finishing.
Sealable aluminium butterfly handle.

R	P	L	A	M	t	D
1/2"	6	76,5	35,5	50	15,5	10,9

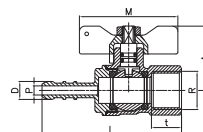

3520 04	1/2"	165	10-180	5,69
---------	------	-----	--------	------

Ref. 3525

● Válvula recta para gas, M-conex.manguera
Acabado superficial cromado. Mando palomilla aluminio.



Gas straight valve, M-hose connection
Chrome-plated surface finishing.
Sealable aluminium butterfly handle.

R	P	L	A	M	t	D
1/2"	6	76,5	35,5	50	14	10,9

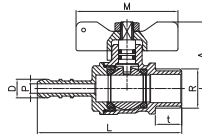

CÓDIGO CODE	MEDIDA SIZE	PESO WEIGHT	CAJA / BOX CARTON	P.V.P. € PRICE €
3525 04	1/2"	155	10-140	5,69

Ref. 3550

● Válvula escuadra para gas, M-M
Acabado superficial cromado.
Mando palomilla aluminio precintable.



Gas square valve, M-M
Chrome-plated surface finishing.
Sealable aluminium butterfly handle.

R	P	L	A	M	t	t1
1/2"	13,5	46	64,5	27	13,5	14

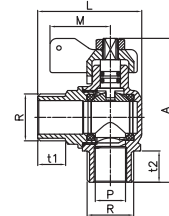

3550 04	1/2"	160	10-140	5,69
---------	------	-----	--------	------

Ref. 3555

● Válvula escuadra para gas, M-H
Acabado superficial cromado.
Mando palomilla aluminio precintable.



Gas square valve, M-F
Chrome-plated surface finishing.
Sealable aluminium butterfly handle.

R	P	L	A	M	t	t1
1/2"	13,5	43	64,5	27	15,5	14

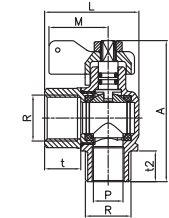

3555 04	1/2"	160	10-140	5,69
---------	------	-----	--------	------

Ref. 3560

● Válvula escuadra para gas, M-conexión manguera
Acabado superficial cromado.
Mando palomilla aluminio precintable.



Gas square valve, M-hose connection
Chrome-plated surface finishing.
Sealable aluminium butterfly handle.

R	P	L	A	M	t	t1
1/2"	6	61,5	64,5	27	14	10,9

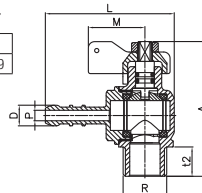

3560 04	1/2"	160	10-140	5,69
---------	------	-----	--------	------

Ref. 3565

● Válvula escuadra para gas, H-M
Acabado superficial cromado.
Mando palomilla aluminio precintable.



Gas square valve, F-M
Chrome-plated surface finishing.
Sealable aluminium butterfly handle.

R	P	L	A	M	t	t1
1/2"	13,5	46	64,5	27	13,5	15,5

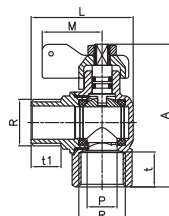

3565 04	1/2"	165	10-140	5,69
---------	------	-----	--------	------

Ref. 3570



● **Válvula escuadra para gas, H-H**
Acabado superficial cromado.
Mando palomilla aluminio precintable.

Gas square valve, F-F
Chrome-plated surface finishing.
Sealable aluminium butterfly handle.

R	P	L	A	M	t
1/2"	13,5	43	64,5	27	15,5

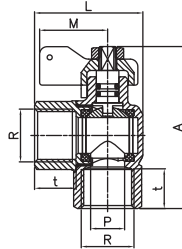

CÓDIGO CODE	MEDIDA SIZE	PESO WEIGHT	CAJA / BOX CARTON	P.V.P. € PRICE €
3570 04	1/2"	170	10-140	5,69

Ref. 3575



● **Válvula escuadra para gas, H-conexión manguera**
Acabado superficial cromado.
Mando palomilla aluminio precintable.

Gas square valve, F-hose connection
Chrome-plated surface finishing.
Sealable aluminium butterfly handle.

R	P	L	A	M	t	D
1/2"	6	61,5	64,5	27	15,5	10,9

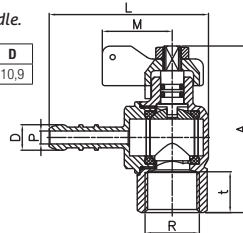

3575 04	1/2"	165	10-140	5,69
---------	------	-----	--------	------

Ref. 3583



● **Válvula de esfera para gas, H-soldar**
Mando palomilla aluminio precintable.

Gas ball valve, F-welding
Sealable aluminium butterfly handle.

R	D	P	L	A	M	t	w
1/2"	15	15	57	35,5	50	17	12
3/4"	22	20	68	43,5	62	17,5	15

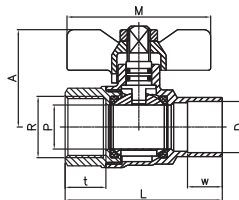

3583 15 04	1/2"xØ15	140	8 - 96	-
3583 22 05	3/4"xØ22	235	8 - 96	7,74

Ref. 70300



● **Kit de seguridad para gas**
Detecta la presencia de gas metano en el ambiente. Para concentraciones del 10% de LIE (límite inferior explosividad). Incluye detector óptico-acústico con alarma y electroválvula. Alimentación 230VCA 50-60 Hz. Sensor catalítico. IP 42. Dimensiones del dispositivo 138x85x44 mm.

Safety gas kit
To detect the presence of gas methane in the environment. For 10% of LEL (lower explosive limit) concentrations. Optical-acoustic detector with alarm and solenoid valve included. Power supply 230VCA 50-60Hz. Catalytic sensor. IP 42. Device dimensions 138x85x44 mm.



70300 04	1/2"	-	1	151,10
70300 05	3/4"	-	1	151,14



4

ELECTROVÁLVULAS SOLENOID VALVES

Gama completa de electroválvulas para diferentes aplicaciones en el sector industrial, en versiones de acción directa, indirecta y combinada.

Complete range of solenoid valves for different applications in the industrial sector, with 3 versions: direct, indirect and combined actioning.



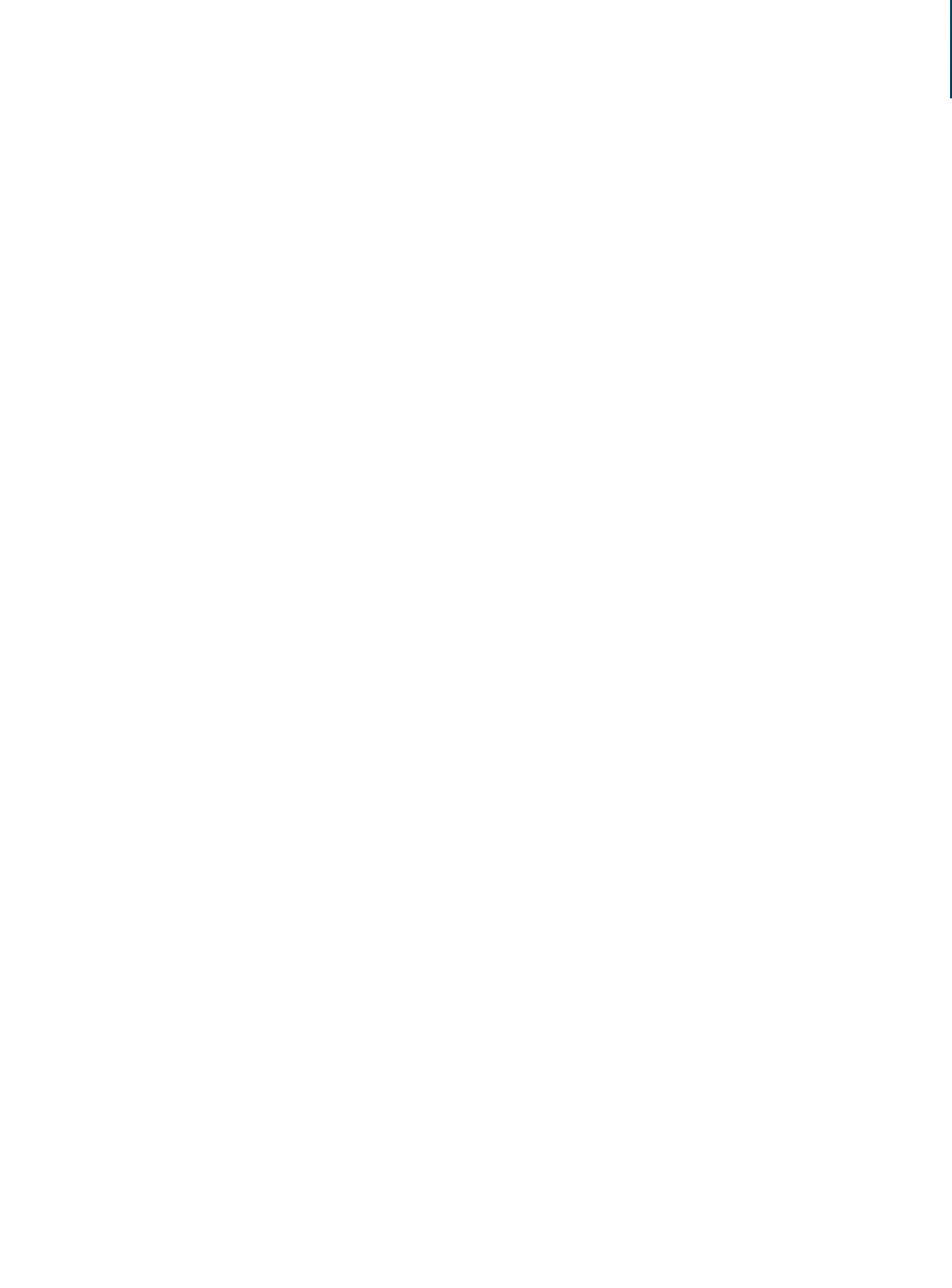

Ref. 4010



Electroválvula 2 vías

PN16. Normalmente cerrada. Acción mixta. Cuerpo latón UNE-EN 12165. Piloto mando acero inox. Membrana de buna + poliamida. Bobina 8W ref.4808 o 14W ref. 4814.

2 ways solenoid valve

PN16. Normally closed. Mixed acting. Body brass UNE-EN 12165. Stainless steel control pilot. Buna + Polyamide membrane. Coil 8W ref. 4808 or 14W ref. 4814.

Recambios

Cjto. membrana con núcleo móvil.

Spare parts

Membrane set with plunger.

DN	A mm.	B mm.	C mm.	TEMP. FLUIDO/ FLUID TEMP.		Ø mm	Presiones / Pressure			Potencia / Power (watt)	Kv l/min
				MIN. °C	MAX. °C		min bar	máx M.O.P.D.			
								AC bar	DC bar		
3/8"	50	89	56	-10	+90	11	0	14	5	8	20
1/2"	50	100	70	-10	+90	16	0	14	2,5	8	40
3/4"	50	100	70	-10	+90	16	0	14	1,5	8	40
1"	65	112	104	-10	+90	25	0	14	6	14	120

BOBINA	D (mm)	E (mm)	F (mm)
8W	30	42	54
14W	52	55	67

CÓDIGO CODE	MEDIDA SIZE	PESO WEIGHT	CAJA / BOX CARTON	P.V.P. € PRICE €
4010 03	3/8"	450	1	62,92
4010 04	1/2"	720	1	64,97
4010 05	3/4"	600	1	64,97
4010 06	1"	1050	1	114,28

Nota: para CC, la bobina debe ser 14W
Note: for DC the coil must be 14W

E011	3/8"	-	-	30,83
E012	1/2"-3/4"	-	-	31,43
E013	1"	-	-	32,80

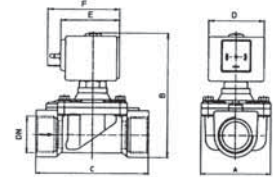

Ref. 4020 - 4022



Electroválvula 2 vías

Disponible con rosca NPT (ref. 4022)
Normalmente cerrada. Acción indirecta. Cuerpo latón UNE-EN 12165. Piloto mando acero inox. Membrana buna (bajo demanda vitón). Bobina 8W ref.4808 o 14W ref. 4814.

2 ways solenoid valve

Available NPT thread (ref. 4022).
Normally closed. Indirect acting. Body brass UNE-EN 12165. Stainless steel control pilot. Buna membrane (viton on request). Coil 8W ref.4808 or 14W ref. 4814.

Recambios

Cjto. núcleo móvil - E020B
Cjto. tubo guía - E025
Membrana - 3/8"-1/2"-E025B
Membrana - 3/4"-1"-E022B
Membrana - 1 1/4"-1 1/2"-E023B
Membrana - 2"-E024B

Spare parts

Plunger set - E020B
Conductor pipe set - E025
Membrane - 3/8"-1/2"-E025B
Membrane - 3/4"-1"-E022B
Membrane - 1 1/4"-1 1/2"-E023B
Membrane - 2"-E024B

DN	PN	A mm.	B mm.	C mm.	TEMP. FLUIDO/ FLUID TEMP.		Ø mm	Presiones / Pressure			Potencia / Power (watt)	Kv l/min
					MIN. °C	MAX. °C		min bar	máx M.O.P.D.			
									AC bar	DC bar		
3/8"	20	40	97	60	-10	+90	13	0,2	16	16	8	60
1/2"	20	40	97	66	-10	+90	13	0,2	16	16	8	70
3/4"	25	65	105	104	-10	+90	19	0,2	16	16	8	140
1"	25	65	112	104	-10	+90	25	0,2	16	16	8	190
1 1/4"	16	98	125	144	-10	+90	35	0,2	10	10	8	400
1 1/2"	16	98	125	144	-10	+90	40	0,2	10	10	8	520
2"	16	118	141	172	-10	+90	50	0,2	10	10	8	750

4020 03	3/8"	450	1	55,25
4020 04	1/2"	720	1	55,80
4020 05	3/4"	1030	1	82,65
4020 06	1"	1170	1	90,77
4020 07	1 1/4"	2650	1	179,49
4020 08	1 1/2"	2650	1	189,94
4020 09	2"	4800	1	259,73

E20B	-	-	-	11,53
E025	-	-	-	21,28
E025B	3/8"-1/2"	-	-	12,82
E022B	3/4"-1"	-	-	20,69
E023B	1 1/4"-1 1/2"	-	-	54,68
E024B	2"	-	-	72,78

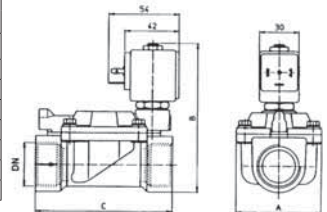

Ref. 4021



Electroválvula 2 vías

Normalmente abierta. Acción indirecta. Cuerpo latón UNE-EN 12165. Piloto mando acero inox. Membrana buna. Bobina 8w ref. 4808. (bajo demanda vitón).

2 ways solenoid valve

Normally opened. Indirect acting. Body brass UNE-EN 12165. Stainless steel control pilot. Buna membrane. Coil 8w ref. 4808 (viton on request).

Recambios

- Cjto. tubo guía - E030
- Membrana - 3/8"-1/2"-E025B
- Membrana - 3/4"-1"-E022B
- Membrana - 1 1/4"-1 1/2"-E023B
- Membrana - 2"-E024B

Spare parts

- Conductor pipe set - E030
- Membrane - 3/8"-1/2"- E025B
- Membrane - 3/4"-1"- E022B
- Membrane - 1 1/4"-1 1/2"- E023B
- Membrane - 2"- E024B

CÓDIGO CODE	MEDIDA SIZE	PESO WEIGHT	CAJA / BOX CARTON	P.V.P. € PRICE €
4021 03	3/8"	450	1	68,15
4021 04	1/2"	720	1	68,78
4021 05	3/4"	1030	1	96,24
4021 06	1"	1170	1	110,37
4021 07	1 1/4"	2650	1	221,19
4021 08	1 1/2"	2650	1	233,24
4021 09	2"	4800	1	273,32

E030	-	-	-	46,61
E025B	3/4"-1/2"	-	-	12,82
E022B	3/4"-1"	-	-	20,69
E023B	1 1/4"-1 1/2"	-	-	54,68
E024B	2"	-	-	72,78

DN	PN	A mm.	B mm.	C mm.	TEMP. FLUIDO/ FLUID TEMP.		Ø	Presiones / Pressure				Potencia / Power	
					MIN. °C	MAX. °C		min bar	máx M.O.P.D.		(watt)	I/min	
									AC bar	DC bar			
3/8"	20	40	97	60	-10	+90	13	0,2	16	16	8	60	
1/2"	20	40	97	66	-10	+90	13	0,2	16	16	8	70	
3/4"	25	65	105	104	-10	+90	19	0,2	16	16	8	140	
1"	25	65	112	104	-10	+90	25	0,2	16	16	8	190	
1 1/4"	16	98	125	144	-10	+90	35	0,2	10	10	8	400	
1 1/2"	16	98	125	144	-10	+90	40	0,2	10	10	8	520	
2"	16	118	141	172	-10	+90	50	0,2	10	10	8	750	

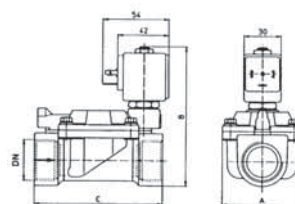

Ref. 4030 - 4031



Electroválvula 2 vías

PN40. Normalmente cerrada. Acción directa. Cuerpo latón UNE-EN 12165. Piloto mando acero inox. Cierre núcleo vitón (otros cierres consultar). Bobina 8W ref.4808

2 ways solenoid valve

PN40. Normally closed. Direct acting. Body brass UNE-EN 12165. Stainless steel control pilot. Viton plunger sealing (consult for other sealings). Coil 8W ref. 4808

(4031)

Igual características anterior. Bobina 14W ref. 4814. Same characteristics as above coil 14W ref. 4814

4030 01	1/8"	300	1	35,60
4030 02	1/4"	300	1	35,60

4031 01	1/8"	580	1	54,27
4031 02	1/4"	580	1	55,81

Recambios

- Cjto. núcleo móvil - E020V
- Cjto. tubo guía - E025

Spare parts

- Plunger set - E020V
- Conductor pipe set - E025

DN	A mm.	B mm.	C mm.	TEMP. FLUIDO/ FLUID TEMP.		Ø	Presiones / Pressure				Potencia / Power	
				MIN. °C	MAX. °C		min bar	máx M.O.P.D.		(watt)	I/min	
								AC bar	DC bar			
1/8"	28	78	41	-10	+140	2,5	0	14	9	8	3,2	
1/8"	28	78	41	-10	+140	2,5	0	30	25	14	3,2	
1/4"	28	78	41	-10	+140	2,5	0	14	9	8	3,2	
1/4"	28	78	41	-10	+140	2,5	0	30	25	14	3,2	

BOBINA	D (mm)	E (mm)	F (mm)
8W	30	42	54
14W	52	55	67

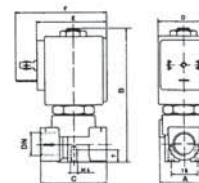

Ref. 4040 - 4041



Electroválvula 2 vías
PN40. Normalmente abierta acción directa. Cuerpo latón UNE-EN 12165. Piloto mando acero inox. Cierre núcleo vitón (otros cierres consultar). Bobina 8W ref.4808.

2 ways solenoid valve
PN40. Normally opened. Direct acting. Body brass UNE-EN 12165. Control pilot stainless steel. Plunger sealing viton (consult for other sealings). Coil 8W ref. 4808. Stainless steel sealing.

(4041)
Igual características anterior. Bobina 14W ref. 4814.
</D1>Same characteristics as above. Coil 14W ref. 4814

Recambios
Cjto. tubo guía - E030

Spare parts
Conductor pipe set - E030

DN	A mm.	B mm.	C mm.	TEMP. FLUIDO/ FLUID TEMP.		Ø	Presiones / Pressure			Potencia / Power	
				MIN. °C	MAX. °C		min bar	máx M.O.P.D. AC bar	DC bar	(watt)	Kv l/min
1/8"	28	78	41	-10	+140	2,5	0	14	14	8	3,2
1/8"	28	78	41	-10	+140	2,5	0	17	17	14	3,2
1/4"	28	78	41	-10	+140	2,5	0	14	14	8	3,2
1/4"	28	78	41	-10	+140	2,5	0	17	17	14	3,2

BOBINA	D (mm)	E (mm)	F (mm)
8W	30	42	54
14W	52	55	67

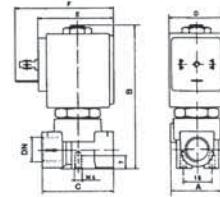

CÓDIGO CODE	MEDIDA SIZE	PESO WEIGHT	CAJA / BOX CARTON	P.V.P. € PRICE €
4040 01	1/8"	300	1	46,78
4040 02	1/4"	300	1	49,23

4041 01	1/8"	580	1	59,37
4041 02	1/4"	580	1	59,37

E030	-	-	1	46,61
------	---	---	---	-------

Ref. 4050



Electroválvula 2 vías
Normalmente cerrada. Acción indirecta. Cuerpo latón UNE-EN 12165. Membrana buna (bajo demanda vitón). Bobina 8W ref.4808.

2 ways solenoid valve
Normally closed. Indirect acting. Body brass UNE-EN 12165. Buna membrane (viton on request). Coil 8W ref. 4808.

Recambios
Cjto. núcleo móvil - E040B
Cjto. membrana - 3/8"-1/2"- E041B
Cjto. membrana - 3/4"- E042B

Spare parts
Plunger set - E040B
Membrane set - 3/8"-1/2"- E041B
Membrane set - 3/4"- E042B

DN	PN	A mm.	B mm.	C mm.	TEMP. FLUIDO/ FLUID TEMP.		Ø	Presiones / Pressure			Potencia / Power	
					MIN. °C	MAX. °C		min bar	máx M.O.P.D. AC bar	DC bar	(watt)	Kv l/min
3/8"	20	40	92	50	-10	+90	12	0,1	20	10	8	35
1/2"	20	40	92	50	-10	+90	12	0,1	20	10	8	45
3/4"	16	50	96	65	-10	+90	18	0,1	16	13	8	50

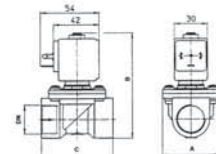

4050 03	3/8"	350	1	48,37
4050 04	1/2"	350	1	48,37
4050 05	3/4"	700	1	56,54

E040B	-	-	1	10,33
E041B	-	-	1	12,54
E042B	-	-	1	46,61

Ref. 4210



Electroválvula 2 vías
PN40. Normalmente cerrada. Acción directa cuerpo latón UNE-EN 12165. Piloto mando acero inox. Cierre vitón. Bobina 5W ref.4805.

2 ways solenoid valve
PN40. Normally closed. Direct acting. Body brass UNE-EN 12165. Stainless steel control pilot. Sealing viton. Coil 5W ref. 4805.

Recambios
Cjto. núcleo móvil - E015V
Cjto. tubo guía - E016

Spare parts
Plunger set - E015V
Conductor pipe set - E016

DN	A mm.	B mm.	C mm.	TEMP. FLUIDO/ FLUID TEMP.		Ø	Presiones / Pressure			Potencia / Power	
				MIN. °C	MAX. °C		min bar	máx M.O.P.D. AC bar	DC bar	(watt)	Kv l/min
1/8"	25	56	30	-10	+140	2,3	0	18	8	5	2,3

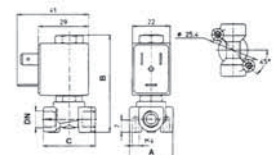

4210 01	1/8"	130	1	26,52
---------	------	-----	---	-------

E015B	-	-	1	8,55
E016	-	-	1	14,17

Ref. 4220



Electroválvula 2 vías
Normalmente cerrada. Acción directa. Cuerpo latón UNE-EN 12165.
Cierre vitón. Bobina 8W ref. 4808.

2 ways solenoid valve
Normally closed. Direct acting. Body brass UNE-EN 12165.
Viton sealing. Coil 8W ref. 4808.

Recambios
Cjto. núcleo móvil - 1/8" - 1/4" - E026V
Cjto. núcleo móvil - 3/8" - 1/2" - E027V

Spare parts
Plunger set - 1/8" - 1/4" - E026V
Plunger set - 3/8" - 1/2" - E027V

DN	PN	A mm.	B mm.	C mm.	TEMP. FLUIDO/ FLUID TEMP.		Ø			Presiones / Pressure			Potencia / Power	
					MIN. °C	MAX. °C	mm	bar	AC bar	DC bar	(watt)	l/min		
1/8"	30	17	62	30	-10	+140	2,8	0	12	6	8	3,5		
1/4"	30	17	62	30	-10	+140	2,8	0	12	6	8	3,5		
3/8"	40	26	76	44	-10	+140	2,8	0	5	2	8	6,5		
3/8"	40	26	76	44	-10	+140	2,8	0	12	8	14	6,5		
1/2"	40	26	76	58	-10	+140	2,8	0	3	1	8	9		
1/2"	40	26	76	58	-10	+140	2,8	0	10	5	14	9		

BOBINA	D (mm)	E (mm)	F (mm)
8W	30	42	54
14W	52	55	67

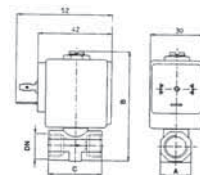

CÓDIGO CODE	MEDIDA SIZE	PESO WEIGHT	CAJA / BOX CARTON	P.V.P. € PRICE €
4220 01	1/8"	220	1	23,21
4220 02	1/4"	200	1	23,21
4220 03	3/8"	370	1	33,07
4220 04	1/2"	400	1	37,06

E026V	-	-	1	6,52
E027V	-	-	1	12,73

Ref. 4232



Electroválvula 2 vías
PN40. Normalmente cerrada. Acción directa. Cuerpo latón UNE-EN 12165. Piloto mando acero inox. Cierre vitón. Bobina 8W ref.4808.

2 ways solenoid valve
PN40. Normally closed. Direct acting. Body brass UNE-EN 12165.
Stainless steel control pilot. Viton sealing. Coil 8W ref. 4808.

Recambios
Cjto. núcleo móvil - E020V
Cjto. tubo guía - E025

Spare parts
Plunger set - E020V
Conductor pipe set - E025

A mm.	B mm.	C mm.	TEMP. FLUIDO/ FLUID TEMP.		Ø mm	Presiones / Pressure			Potencia / Power	
			MIN. °C	MAX. °C		min bar	máx M.O.P.D. AC bar	DC bar	(watt)	l/min
32	63	32	-10	+130	2	0	22	16	8	2

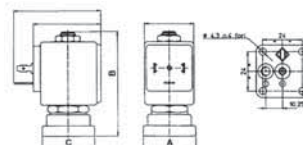

4232 00	b/pl	240	1	35,45
---------	------	-----	---	-------

E020V	-	-	1	12,69
E025	-	-	1	21,28

Ref. 4240



Electroválvula 2 vías
PN25. Normalmente abierta. Acción directa. Cuerpo latón UNE-EN 12165. Piloto mando acero inox. Cierre vitón. Bobina 8W ref.4808.

2 ways solenoid valve
PN25. Normally opened. Direct acting. Body brass UNE-EN 12165.
Stainless steel control pilot. Viton sealing. Coil 8W ref. 4808.

DN	TEMP. FLUIDO/ FLUID TEMP.		Ø mm	Presiones / Pressure			Potencia / Power	
	MIN. °C	MAX. °C		min bar	máx M.O.P.D. AC bar	DC bar	(watt)	l/min
1/8"	-10	+140	2,5	0	18	18	8	3,5

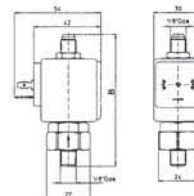

4240 01	1/8"	230	1	34,68
---------	------	-----	---	-------

Ref. 4250



Electroválvula 2 vías

Normalmente cerrada. Acción directa. Cuerpo latón UNE-EN 12165 - polisulf. psu. Cierre silicona fluido separado para distribuidores automático de bebidas. Bobina 8W ref. 4808.

2 ways solenoid valve

Normally closed. Direct acting. Body brass UNE-EN 12165. Silicon sealing fluid separated for automatic drink distributors. Coil 8W ref. 4808.

Recambios

Membrana en silicona - E042S

Spare parts

Silicon membrane - E042S

DN	TEMP. FLUIDO/ FLUID TEMP.		Ø	Presiones / Pressure			Potencia / Power		Kv
	MIN. °C	MAX. °C		min	máx M.O.P.D.		(watt)	l/min	
					AC bar	DC bar			
1/4"	+2	+100	9	0	0,3	0,3	8	2,5	

CÓDIGO CODE	MEDIDA SIZE	PESO WEIGHT	CAJA / BOX CARTON	P.V.P. € PRICE €
4250 02	1/4"	230	1	36,65

E024S	-	-	1	3,90
-------	---	---	---	------

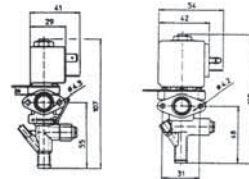

Ref. 4320 - 4322 - 4324 - 4328



(4320) Electroválvula 3 vías

PN 40. Normalmente cerrada. Paso int. Ø2.5. Acción directa. Cuerpo latón UNE-EN 12165. Piloto mando acero inox. Cierre viton bobina 8W ref.4808.

(4320) 3 ways solenoid valve

PN40. Normally closed. Internal bore Ø2.5. Direct acting. Body brass UNE-EN 12165. Stainless steel control pilot - viton sealing. Coil 8W ref. 4808.

(4322)

Igual anterior. Paso interior Ø2

(4322)

Same as above - bore Ø2

(4324)

Igual anterior. Paso interior Ø1,5

(4324)

Same as above - bore Ø1,5

(4328) Electroválvula 3 vías universal

Paso interior Ø1,5. Modelo universal misma presión 3 vías

(4328) 3 ways universal solenoid valve

Internal bore Ø1,5. Universal model same pressure three ways

Recambios

Cjto. núcleo - E038V

4328 Cjto. núcleo - E039V

Cjto. tubo guía - E035

Spare parts

Plunger set - E038V

4328 plunger set - E039V

Conductor pipe set - E035

Ref.	DN	A mm.	B mm.	C mm.	TEMP. FLUIDO/ FLUID TEMP.		Ø	Presiones / Pressures			Potencia / Power		KV
					MIN. °C	MAX. °C		min.	max. MOPD		Watt	l/mn	
									BAR	ACbar			
4320 01	1/8"	27	87	40	-10	+140	2,5	0	6	6	8	3,2	
4322 01	1/8"	27	87	40	-10	+140	2	0	10	10	8	2	
4324 01	1/8"	27	87	40	-10	+140	1,5	0	15	15	8	1,4	
4328 01	1/8"	27	87	40	-10	+140	1,5	0	10	10	8	1,4	
4320 02	1/4"	27	87	40	-10	+140	2,5	0	6	6	8	3,2	
4322 02	1/4"	27	87	40	-10	+140	2	0	10	10	8	2	
4324 02	1/4"	27	87	40	-10	+140	1,5	0	15	15	8	1,4	
4328 02	1/4"	27	87	40	-10	+140	1,5	0	10	10	8	1,4	

4320 01	1/8"	320	1	39,70
4320 02	1/4"	300	1	39,70

4322 01	1/8"	320	1	39,70
4322 02	1/4"	300	1	39,70

4324 01	1/8"	320	1	39,83
4324 02	1/4"	300	1	39,83

4328 01	1/8"	320	1	49,79
4328 02	1/4"	300	1	49,79

E038V	-	-	1	12,89
E039V	-	-	1	15,75
E035	-	-	1	25,37

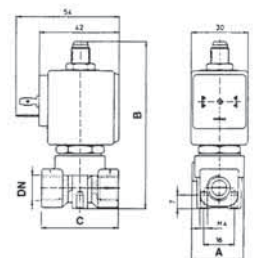

Ref. 4330 - 4332 - 4335 - 4336



(4330) Electroválvula 3 vías
PN40. Normalmente cerrada. Acción directa \varnothing 1,5. Cuerpo latón UNE-EN 12165. Piloto mando acero inox. Cierre vitón (otros cierres consultar). Bobina 8W ref.4808.

(4330) 3 ways solenoid valve
PN 40. Normally closed. Direct acting \varnothing 1.5. Body brass UNE-EN 12165. Stainless steel control pilot. Viton sealing (consult for other sealings). Coil 8W ref. 4808.

(4332)
Igual características anterior. Paso interior \varnothing 2

(4332)
Same characteristics as above - bore \varnothing 2

(4335)
Igual características anterior. Paso int. \varnothing 1,5 cono superior tipo "C"

(4335)
Same characteristics as above - internal bore \varnothing 1.5 top cone type "C"

(4336) Electroválvula 3 vías con cable saliente
Igual características anterior con cierre en rubí.

(4336) 3 ways solenoid valve with external wire
Same characteristics as above with ruby.

Recambios
Cjto. núcleo - E038V
Cjto. tubo guía - E035
Junta tórica inferior - 4825 00

Spare parts
Plunger set - E038V
Conductor pipe set - E035
Lower o'ring - 4825 00

Ref.	TEMP. FLUIDO/ FLUID TEMP.		\varnothing	Presiones / Pressure			Potencia / Power		Kv
	MIN. °C	MAX. °C		min	máx M.O.P.D.		(watt)	l/min	
					bar	AC bar			
4330	-10	+140	1,5	0	15	15	8	1,4	
4332	-10	+140	2	0	10	10	8	2	
4335	-10	+140	1,5	0	15	15	8	1,4	
4336	-40	+180	1,5	0	15	15	8	1,4	

CÓDIGO CODE	MEDIDA SIZE	PESO WEIGHT	CAJA / BOX CARTON	P.V.P. € PRICE €
4330 00	b/pl	230	1	36,44

4332 00	b/pl	230	1	34,04
---------	------	-----	---	-------

4335 00	b/pl	230	1	34,04
---------	------	-----	---	-------

4336 00	b/pl	230	1	44,27
---------	------	-----	---	-------

E038V	-	-	1	12,89
E035	-	-	1	25,37
4825 00	-	-	1	0,26

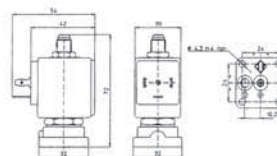

Ref. 4340



Electroválvula 3 vías
PN40. Normalmente cerrada. Acción directa. Cuerpo latón UNE-EN 12165. Piloto mando acero inox. Cierre vitón. Bobina 5W ref.4805.

3 ways solenoid valve
PN40. Normally closed. Direct acting. Body brass UNE-EN 12165. Stainless steel control pilot. Viton sealing. Coil 5W ref. 4805.

(4341)
Igual características anterior con mando manual.

(4341)
Same characteristics as above with manual control.

Recambios
Cjto. núcleo - E009V
Cjto. tubo guía - E010

Spare parts
Plunger set - E009V
Conductor pipe set - E010

DN	A mm.	B mm.	C mm.	TEMP. FLUIDO/ FLUID TEMP.		\varnothing	Presiones / Pressure			Potencia / Power		Kv
				MIN. °C	MAX. °C		min	máx M.O.P.D.		(watt)	l/min	
								bar	AC bar			
1/8"	25	56	30	-10	+140	1,2	0	15	15	5	1	
1/8"	22	64	22	-10	+90	1,2	0		9	5	0,6	

4340 01	1/8"	150	1	29,55
---------	------	-----	---	-------

4341 01	1/8"	150	1	49,30
---------	------	-----	---	-------

E009V	-	-	-	10,74
E010	-	-	-	14,12

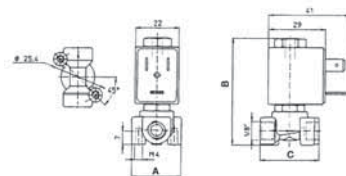

Ref. 4425



Electroválvula 2 vías
PN25. Normalmente cerrada. Acción indirecta. Cuerpo latón UNE-EN 12165. Cierre en PTFE. Piloto mando en acero inox. Bobina 8W ref.4828.

2 ways solenoid valve
PN25. Normally closed. Indirect acting. Body brass UNE-EN 12165. PTFE sealing. Stainless steel control pilot. Coil 8W ref. 4828.

DN	A mm.	B mm.	C mm.	TEMP. FLUIDO/ FLUID TEMP.		Ø mm	Presiones / Pressure			Potencia / Power		Kv
				MIN. °C	MAX. °C		min bar	máx M.O.P.D.		(watt)	l/min	
								AC bar	DC bar			
1/2"	40	114	65	-40	+180	13	0,9	10	10	8	50	
3/4"	48	127	74	-40	+180	19	0,9	10	10	8	90	
1"	62	137	93	-40	+180	25	0,9	10	10	8	160	

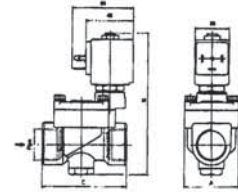

CÓDIGO CODE	MEDIDA SIZE	PESO WEIGHT	CAJA / BOX CARTON	P.V.P. € PRICE €
4425 04	1/2"	-	1	160,24
4425 05	3/4"	-	1	174,14
4425 06	1"	-	1	195,09

Ref. 4426



Electroválvula 2 vías
PN25. Normalmente abierta. Acción indirecta. Cuerpo latón UNE-EN 12165. Cierre en PTFE. Piloto mando en acero inox. Bobina 8W ref.4828.

2 ways solenoid valve
PN25. Normally opened. Indirect acting. Body brass UNE-EN 12165. PTFE sealing. Stainless steel control pilot. Coil 8W ref. 4828.

DN	A mm.	B mm.	C mm.	TEMP. FLUIDO/ FLUID TEMP.		Ø mm	Presiones / Pressure			Potencia / Power		Kv
				MIN. °C	MAX. °C		min bar	máx M.O.P.D.		(watt)	l/min	
								AC bar	DC bar			
1/2"	40	107	65	-40	+180	13	0,9	10	10	8	50	
3/4"	48	127	74	-40	+180	19	0,9	10	10	8	90	
1"	62	137	93	-40	+180	25	0,9	10	10	8	160	

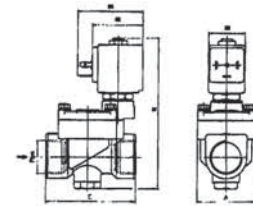

4426 04	1/2"	-	1	179,49
4426 05	3/4"	-	1	195,09
4426 06	1"	-	1	218,46

Ref. 4440



Electroválvula 2 vías
PN25. Normalmente cerrada. Paso angular. Acción directa. Cuerpo latón UNE-EN 12165. Piloto mando acero inox. Membrana PTFE. Bobina 8W ref.4808.

2 ways solenoid valve
PN25. Normally closed. Angle bore. Direct acting. Body brass UNE-EN 12165. Stainless steel control pilot. PTFE membrane. Coil 8W ref. 4808.

Recambios
Cjto. núcleo - E020T
Cjto. tubo guía - E025

Spare parts
Plunger set - E020T
Conductor pipe set - E025

DN	TEMP. FLUIDO/ FLUID TEMP.		Ø mm	Presiones / Pressure			Potencia / Power		Kv
	MIN. °C	MAX. °C		min bar	máx M.O.P.D.		(watt)	l/min	
					AC bar	DC bar			
1/4"	-40	+180	2,5	0	14	5	8	3,2	

4440 02	1/4"	413	1	40,60
---------	------	-----	---	-------

E020T	-	-	1	11,53
E025	-	-	1	21,28
E020V	-	-	1	12,69

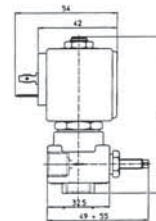

Ref. 4100



Temporizador para descarga de condensados
Instrumento de control creado expresamente para válvulas de descarga. "Timmer on" con su tiempo variable de 0 - 5 a 10 segundos. El "timer off" regula a su vez el intervalo entre dos ciclos de apertura y puede variar entre 0,5 a 45 min. Dos leds indican el estado de funcionamiento.

Condensate removal timer
Timer is a plug-on controller specially design for drain valves. The draining time can be set via the "on" timmer between 0 - 5 and 10 seconds. The "off" timmer allows to adjust the delay time between two draining cycles from 0,5 to 45 minutes. Two leds indicate the output status.

4100	1/4"	413	1	45,93
------	------	-----	---	-------

Especificaciones técnicas / Technical Detailed	
Tensión alimentación salida/ Output voltage	24 a 240V AC/DC 10% 50/60hz
Corriente salida/ Output current	Max. 1A
Consumo corriente/ Power consumption	Max. 8 mA
Temp. Trabajo/ Working temp.	-40°C a + 60°C
Dimensiones/ Dimensions	69 x 43 x mm
Apertura/ On time	0,5 a 10 segundos
Cierre/ Off time	0,5 a 45 minutos

Ref. 4519



Electroválvula 5 vías

Acoplamiento conforme a la norma Namur 5 vías / 2 posiciones. Dispositivo de mando manual. Consumo 5W. Grado de protección: IP 65 con conector y juntas. Racores: 1/4" gas. Presión de trabajo: min. 2 bar máx. 10 bar. Límite de temperaturas: -20°C + 70°C.

5-ways solenoid valve

Coupling according norm Namur functioning 5 ways / 2 positions. Manual control device. Consumption 5W. Protection: IP 65 with connector and seals. Connectors: 1/4" gas. Working pressure: min. 2 bar max. 10 bar. Temperature limits: -20°C +70°C.

Placa adaptador para actuadores GR
Adapter plate for actuators GR

CÓDIGO CODE	MEDIDA SIZE	PESO WEIGHT	CAJA / BOX CARTON	P.V.P. € PRICE €
4519 02	1/4"	460	1	46,68

P4519	-	1	-	22,54
-------	---	---	---	-------

Ref. 4082



Electroválvula 2/2 vías

Normalmente cerrada. Acción indirecta con pistón. Cuerpo latón UNE-EN 12165. Piloto mando acero inox AISI 300. Bobina 12W ø 13. Cierre pistón PTFE modificado. Cierre principal PTFE. Cierre poliamida.

Solenoid valve 2/2 ways

Normally closed. Indirect acting. With piston pilot control. Body brass UNE-EN 12165. Control pilot stainless steel AISI 300. Coil 12W ø 13. Piston seal PTFE modified. Main seal PTFE. Seal poliamida.

DN	TEMP. FLUIDO/ FLUID TEMP.		Ø	Presiones / Pressure			Potencia / Power	
	MIN. °C	MAX. °C		min	máx M.O.P.D.		(watt)	I/min
					bar	AC bar		
3/8"	-10	+60	8	0,7	100		12	14

4082 03	3/8"	-	1	347,00
---------	------	---	---	--------

Ref. 4630



Electroválvula 2 vías

Normalmente cerrada. Acción indirecta (1/4" acción directa). Cuerpo acero inox AISI 316. Piloto mando acero inox. Cierres PTFE. Bobina 8W ref.4808.

2 ways solenoid valve

Normally closed. Indirect acting (1/4" direct acting). Body stainless steel AISI 316. Stainless steel control pilot. PTFE sealings. Coil 8W ref. 4808.

Recambios

Cjto. tubo guía - E025
Cjto. núcleo - E020T
Membrana - 3/8"-1/2"-E049T
Membrana - 3/4"-1"

Spare parts

Conductor pipe set - E025
Plunger set - E020T
Membrane - 3/8"-1/2"-E049T
Membrane - 3/4"-1"

4630 02	1/4"	-	1	94,57
4630 04	1/2"	-	1	345,26
4630 05	3/4"	-	1	451,96
4630 06	1"	-	1	451,96

E025	-	-	1	21,28
E020T	-	-	1	11,53
E049T	-	-	1	28,44
E050T	-	-	1	64,65

DN	PN	A mm.	B mm.	C mm.	TEMP. FLUIDO/ FLUID TEMP.		Ø	Presiones / Pressure			Potencia / Power	
					MIN. °C	MAX. °C		min	máx M.O.P.D.		(watt)	I/min
									bar	AC bar		
1/4"	40	28	78	39	-40	+180	3	0	10	6	8	4
1/2"	25	40	103	73	-10	+180	12	0,5	10	10	8	35
3/4"	25	65	115	104	-10	+180	19	0,5	10	10	8	120
1"	25	65	115	104	-10	+180	25	0,5	10	10	8	130

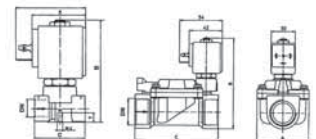

Ref. 4632



Electroválvula 2 vías
PN25. Normalmente cerrada. Acción indirecta. Cuerpo acero inox AISI 316. Piloto mando acero inox. Cierres vitón. Bobina 8W ref.4808.

2 ways solenoid valve
PN25. Normally closed. Indirect acting. Stainless steel body AISI 316. Stainless steel control pilot. Viton sealings. Coil 8W ref. 4808.

Recambios
Cjto. núcleo tubo guía - E025
Cjto. núcleo móvil - E020V
Membrana - 3/8"-1/2"-E052V
Membrana - 3/4"-1"- E053V

Spare parts
Conductor pipe set - E025
Plunger set - E020V
Membrane - 3/8"-1/2"-E052V
Membrane - 3/4"-1"-E053V

DN	A mm.	B mm.	C mm.	TEMP. FLUIDO/ FLUID TEMP.		Ø mm	Presiones / Pressure			Potencia / Power (watt)	Kv l/min
				MIN. °C	MAX. °C		máx M.O.P.D.				
							bar	AC bar	DC bar		
1/2"	40	103	73	-10	+140	12	0,1	20	20	8	35
3/4"	65	115	104	-10	+140	19	0,1	16	16	8	130
1"	65	115	104	-10	+140	25	0,1	16	16	8	160

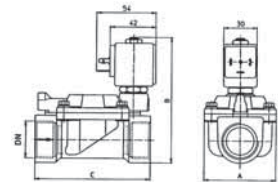

CÓDIGO CODE	MEDIDA SIZE	PESO WEIGHT	CAJA / BOX CARTON	P.V.P. € PRICE €
4632 04	1/2"	-	1	339,85
4632 05	3/4"	-	1	446,06
4632 06	1"	-	1	449,52

E025	-	-	1	21,28
E020V	-	-	1	12,69
E052V	-	-	1	14,59
E053V	-	-	1	44,90

Ref. 4110



Electroválvula para gas
Normalmente cerrada. Cuerpo aluminio. Cierres NBR.
Presión máxima 1 bar. Conforme a Directiva 94/9/CE ATEX y a Directiva Gas 2009/142/CEE.

Gas solenoid valve
Normally closed. Aluminium body. NBR sealings.
Maximum pressure 1 bar.
Following Directive 94/9/CE ATEX and Gas Directive 2009/142/CEE.

Medida/ Size	A mm.	B mm.	C mm.
1/2"	70	135	74
3/4"	70	135	74
1"	70	135	74
1 1/4"	160	210	140
1 1/2"	160	210	140
2"	160	210	140

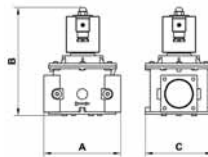

4110 04	1/2"	-	1	234,53
4110 05	3/4"	-	1	234,56
4110 06	1"	-	1	234,56
4110 07	1 1/4"	-	1	468,20
4110 08	1 1/2"	-	1	468,20
4110 09	2"	-	1	468,20

Ref. 4112



Electroválvula para gas
Normalmente cerrada. Cuerpo aluminio. Cierres NBR.
Presión máxima 200 mbar. Conforme a Directiva 94/9/CE ATEX y a Directiva Gas 2009/142/CEE.

Gas solenoid valve
Normally closed. Aluminium body. NBR sealings.
Maximum pressure 200 mbar.
Following Directive 94/9/CE ATEX and Gas Directive 2009/142/CEE.

Medida/ Size	A mm.	B mm.	C mm.
1/2"	70	137	74
3/4"	70	137	74
1"	70	137	74
1 1/4"	160	185	140
1 1/2"	160	185	140
2"	160	185	140

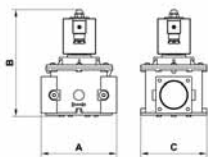

4112 04	1/2"	-	1	112,13
4112 05	3/4"	-	1	112,16
4112 06	1"	-	1	127,82
4112 07	1 1/4"	-	1	252,33
4112 08	1 1/2"	-	1	252,33
4112 09	2"	-	1	318,50

Ref. 4115



Electroválvula con rearme manual para gas
Normalmente cerrada. Cuerpo aluminio. Cierres NBR.
Presión máxima 500 mbar. Conforme a Directiva 94/9/CE ATEX y a Directiva Gas 2009/142/CEE.

Gas manual reset solenoid valve
Normally closed. Aluminium body. NBR sealings.
Maximum pressure 500 mbar.
Following Directive 94/9/CE ATEX and Gas Directive 2009/142/CEE.

Medida/ Size	A mm.	B mm.	C mm.
1/2"	70	163	74
3/4"	70	163	74
1"	70	163	74

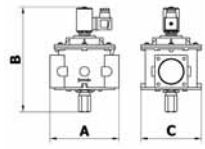

CÓDIGO CODE	MEDIDA SIZE	PESO WEIGHT	CAJA / BOX CARTON	P.V.P. € PRICE €
4115 04	1/2"	-	1	116,28
4115 05	3/4"	-	1	116,28
4115 06	1"	-	1	116,28

Ref. 4118



Electroválvula con rearme manual para gas
Normalmente abierta. Cuerpo aluminio. Cierres NBR.
Presión máxima 500 mbar. Conforme a Directiva 94/9/CE ATEX y a Directiva Gas 2009/142/CEE.

Gas manual reset solenoid valve
Normally opened. Aluminium body. NBR sealings.
Maximum pressure 500 mbar.
Following Directive 94/9/CE ATEX and Gas Directive 2009/142/CEE.

Medida/ Size	A mm.	B mm.	C mm.
1/2"	70	111	74
3/4"	70	111	74
1"	70	111	74

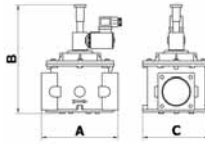

4118 04	1/2"	-	1	51,56
4118 05	3/4"	-	1	51,59
4118 06	1"	-	1	51,59

Ref. 4120



Electroválvula con rearme manual para gas
Normalmente cerrada. Cuerpo latón UNE-EN 12164. Cierres NBR.
Presión máxima 500 mbar. Conforme a Directiva 94/9/CE ATEX y a Directiva Gas 2009/142/CEE.

Gas manual reset solenoid valve
Normally closed. Brass body UNE-EN 12164. NBR sealings.
Maximum pressure 500 mbar.
Following Directive 94/9/CE ATEX and Gas Directive 2009/142/CEE.

Medida/ Size	A mm.	B mm.
1/2"	66	133
3/4"	66	133
1"	82	141

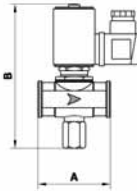

4120 04	1/2"	-	1	120,54
4120 05	3/4"	-	1	120,54
4120 06	1"	-	1	142,91

Ref. 4122



Electroválvula con rearme manual para gas
Normalmente abierta. Cuerpo latón UNE-EN 12164. Cierres NBR.
Presión máxima 500 mbar.
Conforme a Directiva 94/9/CE ATEX y a Directiva Gas 2009/142/CEE.

Gas manual reset solenoid valve
Normally opened. Brass body UNE-EN 12164. NBR sealings.
Maximum pressure 500 mbar.
Following Directive 94/9/CE ATEX and Gas Directive 2009/142/CEE.

Medida/ Size	A mm.	B mm.	C mm.
1/2"	66	107	34
3/4"	66	107	34
1"	82	118	44

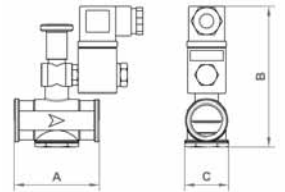

4122 04	1/2"	-	1	58,60
4122 05	3/4"	-	1	58,60
4122 06	1"	-	1	88,83

Ref. 4710 - 4711



Válvula hidráulica manual (4710)
Hidromembrana NR reforzada con nylon. Extremos rosca gas. Cuerpo hierro G-25. Con pintura epoxy. PN-10.

Manual hydraulic valve (4710)
NR hydro-membrane reinforced with nylon. Gas threaded ends. Body iron G-25. With epoxy paint. PN-10.

Válvula hidráulica manual (4711)
Mismas características anterior extremos bridas ISO-5752-15.

Manual hydraulic valve (4711)
Same characteristics as above. Flanged ends ISO-5752-15.

DN	L mm.	H mm.	E mm.	TEMP. FLUIDO/ FLUID TEMP.		Ø mm	Presiones / Pressure		KV m ³ /h
				MIN. °C	MAX. °C		min.	máx.	
2"	175	120	72	5	50	50	1,5	10	100
3"	230	130	110	5	50	80	1,5	10	160
80	280	230	200	5	50	80	1,7	10	180
100	300	250	220	5	50	100	1,7	10	220
150	350	300	285	5	50	150	1,4	10	410
200	400	350	340	5	50	200	1,4	10	480
250	450	600	405	5	50	250	1,4	10	780

CÓDIGO CODE	MEDIDA SIZE	PESO WEIGHT	CAJA / BOX CARTON	P.V.P. € PRICE €
4710 09	2"	3100	1	145,41
4710 11	3"	5200	1	228,27

4711 11	Ø 80	20500	1	490,69
4711 12	Ø 100	24000	1	681,33
4711 14	Ø 150	50000	1	1463,96
4711 16	Ø 200	65000	1	1849,99
4711 18	Ø 250	90000	1	2940,87

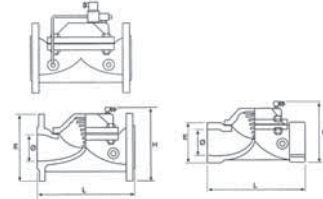

Ref. 4720 - 4721 - 4722 - 4723



Válvula hidráulica con electroválvula (4720)
Hidromembrana NR reforzada con nylon. Extremos rosca gas. Cuerpo hierro G-25 con pintura epoxy. PN-10. Válvula normalmente cerrada (normalmente abierta a petición ref.4722).

Hydraulic valve with solenoid valve (4720)
NR hydro-membrane reinforced with nylon. Gas threaded ends. Body iron G-25 with epoxy paint. PN-10. Valve normally closed (normally open on request ref.4722).

(4721) Mismas características anterior. Extremos bridas ISO-5752-15. Normalmente abierta a petición (ref. 4723)

(4721) Same characteristics as above. Flanged ends ISO-5752-15. Valve normally open on request (ref. 4723)

Recambios
Bobina NC (5W) 4341 01
Bobina NA (8W) 4328 01

Spare parts
Coil NC (5W) 4341 01
Coil NC (8W) 4328 01

DN	L mm.	H mm.	E mm.	TEMP. FLUIDO/ FLUID TEMP.		Ø mm	Presiones / Pressure		KV m ³ /h
				MIN. °C	MAX. °C		min.	máx.	
2"	175	120	72	5	50	50	1,5	10	100
3"	230	130	110	5	50	80	1,5	10	160
80	280	230	200	5	50	80	1,7	10	180
100	300	250	220	5	50	100	1,7	10	220
150	350	300	285	5	50	150	1,4	10	410
200	400	350	340	5	50	200	1,4	10	480
250	450	600	405	5	50	250	1,4	10	780

4720 09	2"	3100	1	192,03
4720 11	3"	5200	1	268,70

4721 11	Ø 80	20500	1	524,17
4721 12	Ø 100	24000	1	695,40
4721 14	Ø 150	50000	1	1497,37
4721 16	Ø 200	65000	1	1680,88
4721 18	Ø 250	90000	1	3077,33

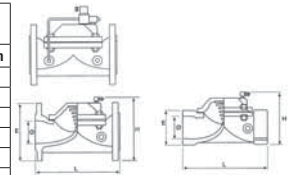

Ref. 4730 - 4731



Válvula hidráulica con flotador (4730)
Hidromembrana NR reforzada con nylon. Extremos rosca gas. Cuerpo hierro G-25. Con pintura epoxy. PN 10.

Floating hydraulic valve (4730)
NR hydro-membrane reinforced with nylon. Gas threaded ends. Body iron G-25. With epoxy paint. PN-10.

(4731) Mismas características anterior. Extremos bridas ISO-5752-15.

(4731) Same characteristics as above. Flanged ends ISO-5752-15.

DN	L mm.	H mm.	E mm.	TEMP. FLUIDO/ FLUID TEMP.		Ø mm	Presiones / Pressure		KV m ³ /h
				MIN. °C	MAX. °C		min.	máx.	
2"	175	120	72	5	50	50	1,5	10	100
3"	230	130	110	5	50	80	1,5	10	160
80	280	230	200	5	50	80	1,7	10	180
100	300	250	220	5	50	100	1,7	10	220
150	350	300	285	5	50	150	1,4	10	410
200	400	350	340	5	50	200	1,4	10	480
250	450	600	405	5	50	250	1,4	10	780

4730 09	2"	3100	1	341,32
4730 11	3"	5200	1	422,10

4731 11	Ø 80	20500	1	676,59
4731 12	Ø 100	24000	1	879,36
4731 14	Ø 150	50000	1	1621,42
4731 16	Ø 200	65000	1	1960,57
4731 18	Ø 250	90000	1	3089,24

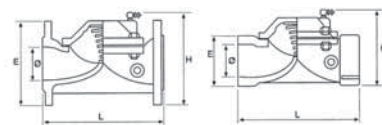

Ref. 4805



Bobina 5W Clase F (155°C)
 Tolerancia de tensión
 C.A. +10% - 15%
 C.C. +10% - 5%
 Voltajes C.A.: 24-48-110-220 50/60 Hz
 C.C.: 12-24

Class F 5W Coil (155°C)
 Pressure tolerance
 A. C+10% - 15%
 D.C. +10% - 5%
 Voltages A.C.: 24-48-110-220 50/60 Hz
 C.C.: 12-24

CÓDIGO CODE	MEDIDA SIZE	PESO WEIGHT	CAJA / BOX CARTON	P.V.P. € PRICE €
4805	-	-	-	13,90

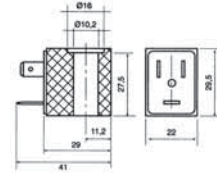

Ref. 4808 - 4858



Bobina 8W Clase F (155°C) (4808)
 Tolerancia de tensión
 C.A. +10% - 15%
 C.C. +10% - 5%
 Voltajes C.A.: 24-48-110-220 50/60 Hz
 C.C.: 12-24

Class F 8W Coil (155°C) (4808)
 Pressure tolerance
 A. C+10% - 15%
 D.C. +10% - 5%
 Voltages A.C.: 24-48-110-220 50/60 Hz
 C.C.: 12-24

4808	-	-	-	15,97
------	---	---	---	-------

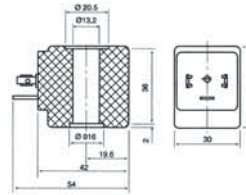

Bobina 8W Clase F (155°C) (4858)
 Class F 8W Coil. Cable saliente.
 Voltaje C.A.: 220 50/60 Hz

Class F 8W Coil (155°C) (4858)
 External wire
 Voltage C.A.: 220 50/60 Hz

4858	-	-	-	20,43
------	---	---	---	-------

Ref. 4828



Bobina 8W Clase H (180°C)
 Tolerancia de tensión
 C.A. +10% - 15%
 C.C. +10% - 5%
 Voltajes C.A.: 24-48-110-220 50/60 Hz
 C.C.: 12-24

Class H 8W Coil (180°C)
 Pressure tolerance
 A. C+10% - 15%
 D.C. +10% - 5%
 Voltages A.C.: 24-48-110-220 50/60 Hz
 C.C.: 12-24

4828	-	-	-	-
------	---	---	---	---

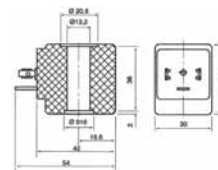

NOVEDAD
NEW

Ref. 4814



Bobina 14W Clase H (180°C)
 Tolerancia de tensión
 C.A. +10% - 15%
 C.C. +10% - 5%
 C.A.: 24-48-110-220 50/60 Hz
 Voltajes C.C.: 12-24

Class H 14W Coil (180°C)
 Pressure tolerance
 A.C +10% - 15%
 D.C. +10% - 5%
 Voltages
 A.C.: 24-48-110-220 50/60 Hz
 C.C.: 12-24

4814	-	-	-	45,25
------	---	---	---	-------

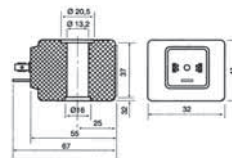

Ref. 4819



Bobina para electroválvulas 5 vías
 Tolerancia de tensión
 C.A. +10% - 15%
 C.C. +10% - 5%
 Voltajes C.A.: 24-48-110-220 50/60 Hz
 C.C.: 12-24

5W solenoid valve coil
 Pressure tolerance
 A.C +10% - 15%
 D.C. +10% - 5%
 Voltages
 A.C.: 24-48-110-220 50/60 Hz
 C.C.: 12-24

CÓDIGO CODE	MEDIDA SIZE	PESO WEIGHT	CAJA / BOX CARTON	P.V.P. € PRICE €
4819	-	-	-	13,90

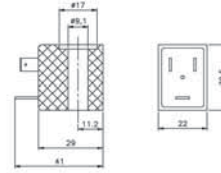

Ref. 4801 - 4803 - 4804



NOVEDAD
NEW

Conector tripolar 5W (4801 05)
 DIN 43650 IP65

3-Pole 5W connector (4801 05)
 DIN 43650 IP65

Conector tripolar 8W (4801 08)
 DIN 43650 IP65

3-Pole 8W connector (4801 08)
 DIN 43650 IP65

Conector tripolar 8W (4803)
 Con señal luminosa. DIN 43650 IP65. Voltaje: 220V - A24 y C24V.

3-Pole 8W connector (4803)
 With luminous signal. DIN 43650 IP65. Voltage: 220V - A24V and C24V.

Conector tripolar 5W (4804)
 Con señal luminosa. DIN 43650 IP65. Voltaje: 220V - A24 y C24V.

3-Pole 5W connector (4804)
 With luminous signal. DIN 43650 IP65. Voltage: 220V - A24 and C24V.

4801 05	-	-	-	2,05
---------	---	---	---	------

4801 08	-	-	-	2,05
---------	---	---	---	------

4803	-	-	-	11,34
------	---	---	---	-------

4804	-	-	-	-
------	---	---	---	---

Ref. K4000



NOVEDAD
NEW

Kit antihumedad
 Aplicable para válvulas de 2 vías. Grado de protección IP67.

Kit against humidity
 Applicable for 2 ways valves. IP67 Protection degree.

K4000	-	-	-	-
-------	---	---	---	---

Precios a consultar / Prices on request

NOTA GENERAL

Piloto mando



Normalmente cerrada
Normaly closed

GENERAL NOTE

Control pilot



Normalmente abierta
Normaly opened



3 vías
3 ways



5

ACCESORIOS LATÓN BRASS ACCESSORIES

Racores de latón forjado sistema RAC-GE para la unión hermética de tuberías de plástico. El Sistema de apriete RAC-GE garantiza una máxima seguridad y fiabilidad para la conexión de tubos en instalaciones hidrosanitarias y de calefacción.

Forged brass fittings with the RAC-GE system for a sealed joining of plastic pipes. The fittings new external structure makes the installation much easier and provides maximum security and reliability for the connection of pipes in hydro-sanitary and heating installations.



SISTEMA DE APRIETE RAC-GE

"RAC-GE" AIR TIGHT SYSTEM



La particularidad principal de este sistema radica en el anillo de apriete. El anillo está fabricado en latón especial con la elasticidad necesaria para el montaje y desmontaje del accesorio. Su geometría simétrica permite ser montado en cualquier posición.

El sistema de fijación es "por puntos" lo que evita la rotura del tubo y ofrece una mayor adaptabilidad a las posibles ovalaciones y/o imperfecciones del tubo.

No es necesario desmontar el accesorio para su instalación.

Particularmente adaptable para la unión de tubos de polietileno de baja y alta densidad.

The special feature of this system lies on the fastening necking. The necking is made out of a special type of brass with the required elasticity for assembling and disassembling the fitting. Its symmetrical shape allows to be mounted in any position.

The locking system is "by points", which prevents the cutting of the pipe and offers better adapting to the possible ovalizations and/or imperfections of the pipe.

It is not necessary to disassemble the fitting to install it.

Specially adaptable for connecting low and high density polyethylene pipes.

INSTRUCCIONES DE MONTAJE

ASSEMBLING INSTRUCTIONS

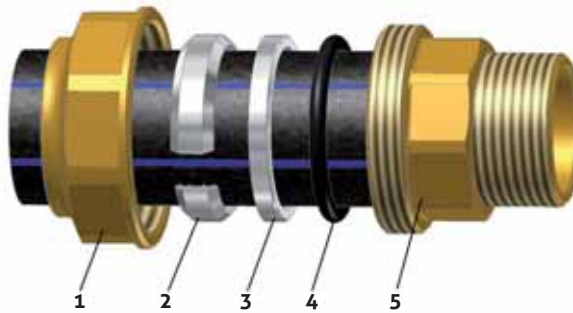

- 1. Tapa / Nut
- 2. Anillo apriete / Necking
- 3. Anillo tope / Washer ring
- 4. Tórica / O'ring
- 5. Cuerpo / Connector

Estas indicaciones evitan que cualquier tipo de deformación en el tubo impida su acoplamiento. En la figura se ilustra un ejemplo de ensamblaje del conjunto.

- A- Desmontar la tuerca (1) del cuerpo del racor (5) e insertarla en el tubo.
- B- Introducir en el tubo el anillo de apriete (2).
- C- Introducir en el tubo el anillo tope (3) con la cara plana en dirección al o'ring.
- D- Introducir en el tubo la junta tórica (4).
- E- Situar el tubo con todos los componentes en el cuerpo del racor (5) hasta que haga tope.
- F- Apretar la tuerca (1) en el cuerpo del racor (5).

These instructions avoid any deformation of the pipe which could prevent its correct assembling. In the figure below there is an exemple illustration of the assembling process.

- A- Disassemble the nut (1) from the connector (5) and insert it into the pipe.*
- B- Insert the necking (2) into the pipe.*
- C- Insert the washer ring (3) into the pipe with the flat face in direction to the o'ring.*
- D- Insert the O'ring (4) into the pipe.*
- E- Place the pipe with all the components inside the body of the connector (5) until the pipe is fixed.*
- F- Tighten the nut (1) to the body of the connector (5).*

Ref. 0012



Racor recto hembra

PN-16 - paso total. Construcción en latón forjado s/UNE-EN 12165. Extremo roscado gas hembra s/ISO 228/1. Conexión a tubería mediante sistema de apriete diseño Genebre "RAC-GE". Temp. de trabajo de -10°C a +90°C. Aplicable para la unión de tubo de polietileno de baja, media y alta densidad.

Straight female connector

PN 16 full bore. Forged brass UNE-EN 12165 Female gas threaded ends ISO 228/1. Genebre's designed "RAC-GE" air tight system for connection to pipe. Working temp.: -10 °C to 90 °C. Applicable for the connection of low, medium and high density polyethylene pipe.

	P	ØD	A
1/2"x PE20	16,5	34	38
3/4"x PE25	22,5	41	44
1"x PE32	28,5	50	51
1 1/4"x PE40	36	60	60
1 1/2"x PE50	45	72	70
2"x PE63	55	88	83

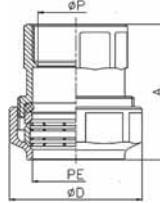

CÓDIGO CODE	MEDIDA SIZE	PESO WEIGHT	CAJA / BOX CARTON	P.V.P. € PRICE €
0012 04	1/2"x20	75	20-280	2,23
0012 05	3/4"x25	110	15-210	3,46
0012 06	1"x32	175	12-108	5,42
0012 07	1 1/4"x40	275	6-54	8,96
0012 08	1 1/2"x50	435	4-36	12,97
0012 09	2"x63	700	2-24	22,44



Racor recto hembra con bridas

Características de racor recto hembra. Tornillo fijación: inox M10 DIN 933-8.8. Arandela dentada: inox J10, 5 DIN 6798.

Straight female connector with flanges

Same characteristics than straight female connector. Fastening screw: inox M10 DIN 933-8.8. Serrated washer: inox J10,5 DIN 6798.

	P	ØD	Ød	A
2 1/2"x75	65	132	76,5	93
3"x90	80	150	92	105
4"x110	100	176	112	123

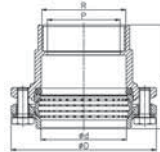

0012 10	2 1/2"x75	1326	4-16	47,42
0012 11	3"x90	1927	2-18	69,97
0012 12	4"x110	3256	2-8	131,74

Ref. 0017



Racor recto macho

PN-16 - paso total. Construcción en latón forjado s/UNE-EN 12165. Extremo roscado gas macho s/ISO 7/1. Conexión a tubería mediante sistema de apriete diseño Genebre "RAC-GE". Temperatura de trabajo de -10°C a 90°C. Aplicable para la unión de tubo de polietileno de baja, media y alta densidad.

Straight male connector

PN 16 full bore. Forged brass UNE-EN 12165. Male gas threaded ends ISO 7/1. Genebre's designed "RAC-GE" air tight system for connection to pipe. Working temp.: -10 °C to 90 °C. Applicable for the connection of low, medium and high density polyethylene pipe.

	P	ØD	A
1/2"x PE20	15	34	39
3/4"x PE25	20	41	45
1"x PE32	26	50	53
1 1/4"x PE40	34,5	60	65
1 1/2"x PE50	40	72	73
2"x PE63	51	88	89

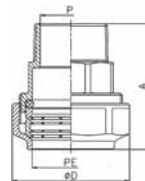

0017 04	1/2"x20	70	20-360	2,20
0017 05	3/4"x25	110	15-210	3,37
0017 06	1"x32	180	12-108	5,39
0017 07	1 1/4"x40	295	6-54	8,97
0017 08	1 1/2"x50	450	4-36	13,12
0017 09	2"x63	765	2-24	22,29



Racor recto macho con bridas

Características de racor recto macho. Tornillo fijación: inox M10 DIN 933-8.8. Arandela dentada: inox J10,5 DIN 6798.

Straight male connector with flanges

Same characteristics than straight male connector. Fastening screw: inox M10 DIN 933-8.8. Serrated washer: inox J10,5 DIN 6798.

	P	ØD	Ød	A
2 1/2"x75	65	132	75	93
3"x90	80	150	90	105
4"x110	100	176	110	123

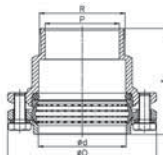

0017 10	2 1/2"x75	1297	4-16	47,07
0017 11	3"x90	1889	2-18	68,18
0017 12	4"x110	3208	2-8	131,74

Ref. 0022



Racor acoplamiento recto

PN-16 - paso total. Construcción en latón forjado s/UNE-EN 12165. Conexión a tubería mediante sistema de apriete diseño Genebre "RAC-GE". Temperatura de trabajo de -10°C a +90°C. Aplicable para la unión de tubo de polietileno de baja, media y alta densidad.

Straight double coupling connector

PN 16 full bore. Forged brass UNE-EN 12165. Genebre's designed "RAC-GE" air tight system for connection to pipe. Working temp.: -10°C to 90 °C. Applicable for the connection of low, medium and high density polyethylene pipe.

	P	ØD	A
1/2"x PE20	16,5	34	50
3/4"x PE25	22,5	41	59
1"x PE32	28,5	50	71
1 1/4"x PE40	36	60	86
1 1/2"x PE50	45	72	100
2"x PE63	55	88	125

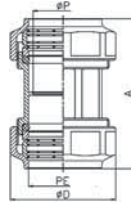

CÓDIGO CODE	MEDIDA SIZE	PESO WEIGHT	CAJA / BOX CARTON	P.V.P. € PRICE €
0022 04	20x20	110	12-216	3,52
0022 05	25x25	170	12-132	5,45
0022 06	32x32	280	8-64	8,66
0022 07	40x40	450	4-36	13,50
0022 08	50x50	740	2-28	22,08
0022 09	63x63	1200	2-12	36,11



Racor acoplamiento recto con bridas

Características de racor acoplamiento recto. Tornillo fijación: inox M10 DIN 933-8.8. Arandela dentada: inox J10,5 DIN 6798.

Straight double coupling connector with flanges

Same characteristics than straight double coupling connector. Fastening screw: inox M10 DIN 933-8.8. Serrated washer: inox J10,5 DIN 6798.

	P	ØD	Ød	A
75x75	65	132	75	134
90x90	80	150	90	155
110x110	100	176	110	185

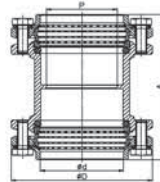

0022 10	75x75	2168	4-8	78,54
0022 11	90x90	3149	2-12	114,43
0022 12	110x110	5384	1-8	241,85

Ref. 0032



Racor "T" triple acoplamiento

PN-16 - paso total. Construcción en latón forjado s/UNE-EN 12165. Conexión a tubería mediante sistema de apriete diseño Genebre "RAC-GE". Temperatura de trabajo de -10°C a +90°C. Aplicable para la unión de tubo de polietileno de baja, media y alta densidad.

"T" triple coupling connector

PN 16 full bore. Body and nut: forged brass UNE-EN 12165. Genebre's designed "RAC-GE" air tight system for connection to pipe. Working temp.: -10 °C to 90°C. Applicable for the connection of low, medium and high density polyethylene pipe.

	P	ØD	A	L
1/2"x PE20	14	34	37	74
3/4"x PE25	19	41	43	87
1"x PE32	24	50	53	106
1 1/4"x PE40	30,5	60	64	129
1 1/2"x PE50	38	72	77	154
2"x PE63	47,5	88	96	192

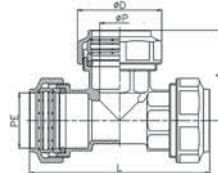

0032 04	20x20	190	6-84	6,15
0032 05	25x25	295	6-54	9,46
0032 06	32x32	485	4-28	15,02
0032 07	40x40	810	4-24	24,16
0032 08	50x50	1305	2-12	38,89
0032 09	63x63	2185	1-6	65,81

Nota: El artículo 0032 12 (Ø110) se obtiene a partir de los artículos 0037 12 + 0017 12

Note: Item 0032 12 (Ø110) is obtained through items 0037 12 + 0017 12



Racor "T" triple acoplamiento con bridas

Características racor "T" triple acoplamiento. Tornillo fijación: inox M10 DIN 933-8.8. Arandela dentada: inox J10,5 DIN 6798.

"T" triple coupling connector with flanges

Same characteristics than "T" triple coupling connector. Fastening screw: inox M10 DIN 933-8.8. Serrated washer: inox J10,5 DIN 6798.

	P	ØD	L	A	Ød
2 1/2"x75	65	132	219	109	75
3"x90	80	150	257	128	95

0032 10	75x75	3717	1-4	144,26
0032 11	90x90	5518	1-3	214,53

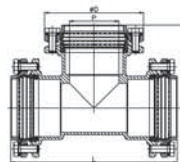

Nota: El artículo 0032 12 (Ø110) se obtiene a partir de los artículos 0037 12 + 0017 12.

Note: Item 0032 12 (Ø110) is obtained through items 0037 12 + 0017 12.

Ref. 0037



Racor "T" hembra

PN-16 - paso total. Construcción en latón forjado s/UNE-EN 12165. Extremo roscado gas hembra s/ISO 228/1. Conexión a tubería mediante sistema de apriete diseño Genebre "RAC-GE". Temperatura de trabajo de -10°C a +90°C. Aplicable para la unión de tubo de polietileno de baja, media y alta densidad.

"T" female connector

PN 16 full bore. Forged brass UNE-EN 12165. Female gas threaded ends ISO 228/1. Genebre's designed "RAC-GE" air tight system for connection to pipe. Working temp.: -10 °C to 90 °C. Applicable for the connection of low, medium and high density polyethylene pipe.

	P	ØD	A	L
1/2"x PE20	14	34	23	74
3/4"x PE25	19	41	27,5	87
1"x PE32	24	50	32	106
1 1/4"x PE40	30,5	60	38	129
1 1/2"x PE50	38	72	45,5	154
2"x PE63	47,5	88	53,5	192

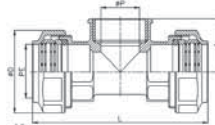

CÓDIGO CODE	MEDIDA SIZE	PESO WEIGHT	CAJA / BOX CARTON	P.V.P. € PRICE €
0037 04	1/2"x20	190	8-112	4,76
0037 05	3/4"x25	290	6-84	7,32
0037 06	1"x32	475	4-36	11,78
0037 07	1 1/4"x40	790	4-24	18,64
0037 08	1 1/2"x50	1250	2-14	30,02
0037 09	2"x63	2070	2-8	50,67



Racor "T" hembra con bridas

Características racor "T" hembra. Tornillo fijación: inox M10 DIN 933-8.8. Arandela dentada: inox J10, 5 DIN 6798.

"T" female connector with flanges

Same characteristics than "T". Female connector. Fastening screw: inox M10 DIN 933-8.8. Serrated washer: inox J10,5 DIN 6798.

	P	ØD	L	A	Øt/ Øp
2 1/2"x75	65	132	202	75	75
3"x90	80	150	239	82	90
4"x110	100	176	279	98	110

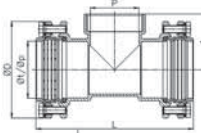

0037 10	2 1/2"x75	2816	1-6	114,12
0037 11	3"x90	4183	1-3	163,96
0037 12	4"x110	7341	1-4	295,46

Ref. 0042



Racor "L" codo macho

PN-16 - paso total. Construcción en latón forjado s/UNE-EN 12165. Extremo roscado gas macho s/ISO 7/1. Conexión a tubería mediante sistema de apriete diseño Genebre "RAC-GE". Temperatura de trabajo de -10°C a +90°C. Aplicable para la unión de tubo de polietileno de baja, media y alta densidad.

"L" male elbow connector

PN 16 full bore. Forged brass UNE-EN 12165. Male gas threaded ends ISO 7/1. Genebre's designed "RAC-GE" air tight system for connection to pipe. Working temp.: -10 °C to 90 °C. Applicable for the connection of low, medium and high density polyethylene pipe.

	P	ØD	L
1/2"x PE20	14	34	29,5
3/4"x PE25	19	41	35
1"x PE32	24	50	42,5
1 1/4"x PE40	30,5	60	51,5
1 1/2"x PE50	38	72	57,5
2"x PE63	47,5	88	69

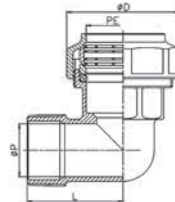

0042 04	1/2"x20	90	15-210	3,12
0042 05	3/4"x25	145	12-108	4,48
0042 06	1"x32	235	8-72	7,03
0042 07	1 1/4"x40	385	6-36	12,59
0042 08	1 1/2"x50	605	4-24	17,53
0042 09	2"x63	1040	2-12	30,19



Racor "L" codo macho con bridas

Características racor "L" codo macho. Tornillo fijación: inox M10 DIN 933-8.8. Arandela dentada: inox J10, 5 DIN 6798.

"L" male elbow connector with flanges

Same characteristics than "L" male elbow connector. Fastening screw: inox M10 DIN 933-8.8. Serrated washer: inox J10,5 DIN 6798.

Medida	P	ØD	L	Øt/ Øp
2 1/2"x75	65	132	94	75
3"x90	80	150	104	90

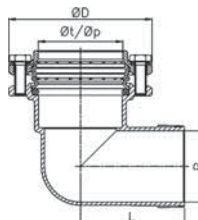

0042 10	2 1/2"x75	1819	1-6	72,45
0042 11	3"x90	2779	1-8	109,79

Ref. 0047



Racor "L" codo hembra

PN-16 - paso total. Construcción en latón forjado s/UNE-EN 12165. Extremo roscado gas hembra s/ISO 228/1. Conexión a tubería mediante sistema de apriete diseño Genebre "RAC-GE". Temperatura de trabajo de -10°C a +90°C. Aplicable para la unión de tubo de polietileno de baja, media y alta densidad.

"L" female elbow connector

PN 16 - full bore. Forged brass UNE-EN 12165. Female gas threaded ends ISO 228/1. Genebre's designed "RAC-GE" air tight system for connection to pipe. Working temp.: -10 °C to 90 °C. Applicable for the connection of low, medium and high density polyethylene pipe.

	P	ØD	L
1/2"x PE20	14	34	23
3/4"x PE25	19	41	27,5
1"x PE32	24	50	32
1 1/4"x PE40	30,5	60	38
1 1/2"x PE50	38	72	45,5
2"x PE63	47,5	88	53,5

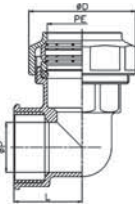

CÓDIGO CODE	MEDIDA SIZE	PESO WEIGHT	CAJA / BOX CARTON	P.V.P. € PRICE €
0047 04	1/2"x20	95	15-210	3,00
0047 05	3/4"x25	150	10-90	4,51
0047 06	1"x32	235	8-48	7,05
0047 07	1 1/4"x40	385	6-36	11,87
0047 08	1 1/2"x50	630	4-24	18,91
0047 09	2"x63	1055	2-12	31,76



Racor "L" codo hembra con bridas

Características racor "L" codo hembra. Tornillo fijación: inox M10 DIN 933-8.8. Arandela dentada: inox J10, 5 DIN 6798.

"L" female elbow connector with flanges

Same characteristics than "L" female elbow connector. Fastening screw: inox M10 DIN 933-8.8. Serrated washer: inox J10, 5 DIN 6798.

	P	ØD	L	Øt/ Øp
2 1/2"x75	65	132	75	75
3"x90	80	150	82	90
4"x110	100	176	98	110

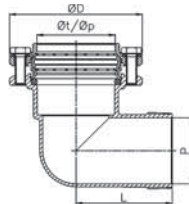

0047 10	2 1/2"x75	1757	1-6	73,51
0047 11	3"x90	2670	1-8	109,69
0047 12	4"x110	4668	1-4	189,68

Ref. 0052



Racor "L" codo acoplamiento

PN-16 - paso total. Construcción en latón forjado s/UNE-EN 12165. Conexión a tubería mediante sistema de apriete diseño Genebre "RAC-GE". Temperatura de trabajo de -10°C a +90°C. Aplicable para la unión de tubo de polietileno de baja, media y alta densidad.

"L" elbow coupling connector

PN 16 - full bore. Forged brass UNE-EN 12165. Genebre's designed "RAC-GE" air tight system for connection to pipe. Working temp.: -10 °C to 90 °C. Applicable for the connection of low, medium and high density polyethylene pipe.

	P	ØD	A
1/2"x PE20	14	34	37
3/4"x PE25	19	41	43
1"x PE32	24	50	53
1 1/4"x PE40	30,5	60	64
1 1/2"x PE50	38	72	77
2"x PE63	47,5	88	96

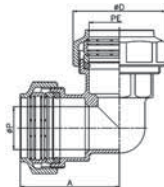

0052 04	20x20	130	12-108	4,24
0052 05	25x25	205	10-90	6,90
0052 06	32x32	330	6-42	10,76
0052 07	40x40	550	4-24	17,09
0052 08	50x50	905	2-18	26,53
0052 09	63x63	1530	1-8	45,33

Nota: El artículo 0052 12 (Ø110) se obtiene a partir de los artículos 0047 12 + 0017 12

Note: Item 0052 12 (Ø110) is obtained through items 0047 12 + 0017 12



Racor "L" codo acoplamiento con bridas

Características racor "L" codo acoplamiento. Tornillo fijación: inox M10 DIN 933-8.8. Arandela dentada: inox J10, 5 DIN 6798.

"L" elbow coupling connector with flanges

Same characteristics than "L" elbow coupling connector. Fastening screw: inox M10 DIN 933-8.8. Serrated washer: inox J10, 5 DIN 6798.

	P	ØD	L	Øt/ Øp
75x75	65	132	115	75
90x90	80	150	128	90

0052 10	75x75	2609	1-6	108,40
0052 11	90x90	3932	1-4	154,25

Nota: El artículo 0052 12 (Ø110) se obtiene a partir de los artículos 0047 12 + 0017 12.

Note: Item 0052 12 (Ø110) is obtained through items 0047 12 + 0017 12.

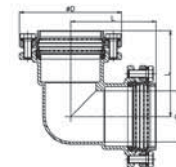

Ref. 0049



● **Racor "L" codo hembra con fijación a pared**
 PN-16 - paso total. Construcción en latón forjado s/UNE-EN 12165. Extremo roscado gas hembra s/ISO 228/1. Conexión a tubería mediante sistema de apriete diseño Genebre "RAC-GE". Temperatura de trabajo de -10°C a +90°C. Aplicable para la unión de tubo de polietileno de baja, media y alta densidad.

"L" female elbow connector with wall fixation
 PN 16 full bore. Forged brass UNE-EN 12165. Female gas threaded ends ISO 228/1. Genebre's designed "RAC-GE" air tight system for connection to pipe. Working temp.: -10 °C to 90 °C. Applicable for the connection of low, medium and high density polyethylene pipe.

	P	ØD	L	A
1/2"x PE20	14	34	23	45
3/4"x PE25	19	41	27,5	53,5
1"x PE32	24	50	32	62

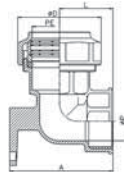

CÓDIGO CODE	MEDIDA SIZE	PESO WEIGHT	CAJA / BOX CARTON	P.V.P. € PRICE €
0049 04	1/2"x20	130	16-128	4,26
0049 05	3/4"x25	190	14-84	6,07
0049 06	1"x32	285	6-48	8,94

Ref. 0055



● **Boquilla inoxidable**
 Boquilla acero inoxidable AISI 304 de refuerzo para la utilización de racores en gas y agua caliente.

Stainless steel nozzle
 Reinforcement stainless steel AISI 304 nozzle for using gas and hotwater connectors.

R	A	B	C	F
20	18	13,7	31	1
25	24	18,7	36	1
32	31,5	25,7	39	1
40	39	32,2	48	1
50	49	40,4	54	1
63	59,5	51	67	1
75	70	60,7	78,5	1,5
90	84	73,2	86,5	1,5
110	99	88,06	110	2

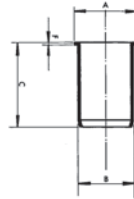

0055 04	20	10	100-2400	1,30
0055 05	25	15	75-2025	1,35
0055 06	32	24	50-1150	1,73
0055 07	40	40	30-420	2,24
0055 08	50	58	20-280	3,29
0055 09	63	92	10-140	4,00
0055 10	75	163	8-104	7,51
0055 11	90	236	6-78	10,15
0055 12	110	400	2-36	36,56

Ref. 0061



● **Junta tórica**

O'ring

Medida/ Size	Junta/ O'ring
20	OR 20 x 2,5
25	OR 25 x 3
32	OR 32 x 3,5
40	OR 40 x 4
50	OR 50 x 4
63	OR 63 x 5
75	OR 75 x 7
90	OR 90 x 8
110	OR 110 x 8

0061 04	20	0	20	0,39
0061 05	25	0,5	20	0,46
0061 06	32	1	10	0,51
0061 07	40	2	10	0,55
0061 08	50	3	10	0,68
0061 09	63	5	5	1,13
0061 10	75	11	1	2,89
0061 11	90	18	1	3,53
0061 12	110	21	1	3,98

Ref. 0062



● **Anillo tope**

Washer ring

0062 04	20	3	20	0,56
0062 05	25	5	20	0,65
0062 06	32	10	10	0,76
0062 07	40	17	10	0,85
0062 08	50	20	10	1,23
0062 09	63	38	5	2,11
0062 10	75	75	1	4,95
0062 11	90	105	1	6,91
0062 12	110	135	1	12,90

Ref. 0063



● **Anillo apriete**

Necking

0063 04	20	5	20	1,11
0063 05	25	9	20	1,32
0063 06	32	14	10	1,68
0063 07	40	23	10	2,34
0063 08	50	39	10	3,39
0063 09	63	62	5	3,92
0063 10	75	95	1	4,61
0063 11	90	130	1	6,45
0063 12	110	200	1	15,40

SISTEMA DE APRIETE VALVEX

"VALVEX" AIR TIGHT SYSTEM



- 1. Cuerpo / Body
- 2. Tuerca / Nut
- 3. Junta tórica / O' ring
- 4. Anilla junta / Washer ring
- 5. Anillo de apriete / Necking
- 6. Boquilla para gas / Nozzle

INSTRUCCIONES DE MONTAJE

El racor VALVEX ha sido estudiado cuidadosamente para facilitar la operación del montaje y por tanto, no requiere ninguna habilidad especial para su instalación. Sin embargo, aconsejamos seguir la operación de acoplamiento en el tubo, según el orden que a continuación citamos, respetando unas simples indicaciones:

- A- Desmontar la tuerca o la brida de cierre e insertarla en el tubo.
- B- Introducir en el tubo el anillo de apriete (5).
- C- Introducir en el tubo el anillo - junta (4).
- D- Introducir en el tubo la junta tórica (3).
- E- Situar el tubo con todos los componentes en el cuerpo del racor hasta que el tubo no salga del fondo del mismo.
- F- Apretar la tuerca o la brida en el cuerpo del racor.

Estas simples indicaciones evitan que imperfecciones en el tubo (Ej. imperfecciones residuales en el corte) impidan el perfecto acoplamiento, y en consecuencia un perfecto cierre.

ASSEMBLING INSTRUCTIONS

The VALVEX connector has been carefully studied in order to facilitate the assembling and therefore, it does not require any special skill to install it. However, we strongly recommend you to follow the assembling instructions for the pipe, in order, as listed below:

- A- Disassemble the nut or the closing flange and insert it into the pipe.
- B- Insert the necking (5) into the pipe.
- C- Insert the washer ring (4) into the pipe.
- D- Insert the o'ring (3) into the pipe.
- E- Place the pipe with all the components inside the body of the connector until the pipe keeps fixed inside.
- F- Tighten the nut or flange to the body of the connector.

These assembling instructions avoid that any imperfections in the pipe (e.g. residuals in the cut) could prevent the perfect assembling and sealing.

Ref. 0010

Racor hembra



Female brass connector

R	A	B	C
1/2"x20	34	27	39,5
3/4"x25	40	33	44,8
1"x32	50	40	49,8
1 1/4"x40	61	50	57,4
1 1/2"x50	71	60	65,4
2"x63	89	75	81,3

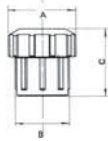

Racor hembra con bridas



Female connector with flanges

R	A	B	C
2 1/2"x75	135	88	99,8
3"x90	154	104	111,4
4"x110	180	130	147

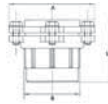

CÓDIGO CODE	MEDIDA SIZE	PESO WEIGHT	CAJA / BOX CARTON	P.V.P. € PRICE €
0010 04	1/2"x20	86	20-320	2,80
0010 05	3/4"x25	126	15-240	3,89
0010 06	1"x32	210	12-120	6,21
0010 07	1 1/4"x40	340	6-60	10,48
0010 08	1 1/2"x50	472	4-72	15,77
0010 09	2"x63	794	2-38	26,85

0010 10	2 1/2"x75	1530	4-16	56,50
0010 11	3"x90	2215	2-16	80,88
0010 12	4"x110	4468	2-8	175,88

Ref. 0015

Racor macho



Male brass connector

R	A	B	C
1/2"x20	34	27	43
3/4"x25	40	33	48
1"x32	50	40	54,5
1 1/4"x40	61	50	62,5
1 1/2"x50	71	60	67,5
2"x63	89	75	89

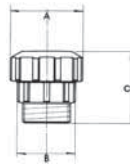

Racor macho con bridas



Male brass with flanges

R	A	B	C
2 1/2"x75	135	88	105
3"x90	154	104	115
4"x110	180	130	143

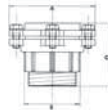

0015 04	1/2"x20	82	20-320	2,94
0015 05	3/4"x25	118	15-240	3,95
0015 06	1"x32	202	12-120	6,62
0015 07	1 1/4"x40	338	6-60	11,23
0015 08	1 1/2"x50	440	4-72	15,40
0015 09	2"x63	790	2-38	27,63

0015 10	2 1/2"x75	1553	4-16	57,08
0015 11	3"x90	2218	2-16	81,34
0015 12	4"x110	4320	2-8	173,92

Ref. 0020

Racor acoplamiento recto



Straight coupling double connector

R	A	B	C
20x20	34	27	52
25x25	40	33	59,5
32x32	50	40	67,1
40x40	61	50	77,3
50x50	71	60	89,3
63x63	89	75	115,6

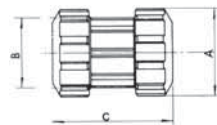

Racor acoplamiento recto con bridas



Straight coupling double connector with flanges

R	A	B	C
75x75	135	88	150,6
90x90	154	104	169,8
110x110	180	130	221

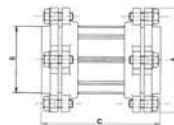

0020 04	20x20	132	12-192	4,59
0020 05	25x25	190	10-160	6,45
0020 06	32x32	305	8-104	9,86
0020 07	40x40	512	4-40	16,06
0020 08	50x50	662	2-48	23,31
0020 09	63x63	1242	2-24	41,76

0020 10	75x75	2513	4-12	95,27
0020 11	90x90	4682	2-8	136,36
0020 12	110x110	7445	1-4	319,68

Ref. 0025

● Racor acoplamiento alargado



Long coupling double connector

R	A	B	C	C
32	50	40	115	50
40	61	50	125	50
50	71	60	139	50
63	89	75	163	50

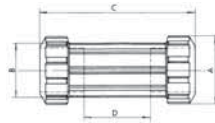

CÓDIGO CODE	MEDIDA SIZE	PESO WEIGHT	CAJA / BOX CARTON	P.V.P. € PRICE €
0025 06	32	406	6-72	15,90
0025 07	40	660	4-36	24,30
0025 08	50	910	2-36	35,33
0025 09	63	1520	2-14	58,57

Ref. 0030

● Racor "T" triple



"T" triple connector

R	A	B	E
20	34	77	38
25	40	90,6	45,3
32	50	104,6	52,3
40	61	124,8	62,4
50	71	144,8	72,4
63	89	184,6	92,3

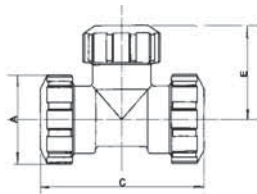

0030 04	20	228	6-144	8,41
0030 05	25	338	6-108	11,59
0030 06	32	556	4-52	18,91
0030 07	40	950	4-36	31,55
0030 08	50	1264	2-28	45,37
0030 09	63	2270	1-12	82,00

Racor "T" triple con bridas



"T" triple connector with flanges

R	A	B	E
75	135	231,6	116
90	154	266,8	133

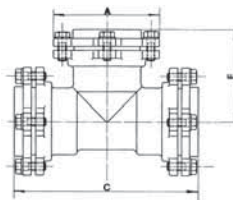

0030 10	75	4190	1-4	169,77
0030 11	90	6438	1-2	251,48

Nota: Para conseguir el racor "T" de 110x4" pedir figura 0035 + 0015.

Note: To obtain "T" connector 110x4" you must request for 0035 and 0015 connector.

Ref. 0035

● Racor "T" hembra



"T" triple female connector

R	A	C	E
1/2"x20	34	77	22
3/4"x25	40	90,6	26
1"x32	50	104,6	30
1 1/4"x40	61	124,8	37
1 1/2"x50	71	142,8	42,5
2"x63	89	184,6	51

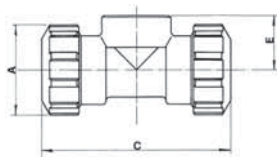

0035 04	1/2"x20	180	8-192	6,60
0035 05	3/4"x25	275	6-96	9,35
0035 06	1"x32	435	4-72	14,73
0035 07	1 1/4"x40	744	4-48	23,95
0035 08	1 1/2"x50	1000	2-26	34,64
0035 09	2"x63	1817	2-14	63,98

Racor "T" hembra con bridas



"T" triple female connector with flanges

R	A	C	E
2 1/2"x75	135	225,6	75
3"x90	154	258,4	85
4"x110	180	314	100

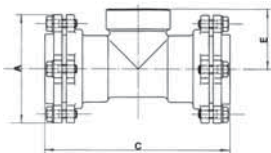

0035 10	2 1/2"x75	3450	1-8	130,97
0035 11	3"x90	4960	1-4	189,49
0035 12	4"x110	9740	1-2	485,40

Ref. 0040

● Racor "L" codo macho

"L" male elbow connector



R	A	C	E
1/2"x20	34	33	36,5
3/4"x25	40	37	42,3
1"x32	50	44	50,3
1 1/4"x40	61	51	59,4
1 1/2"x50	71	60	68,4
2"x63	89	71	87,3

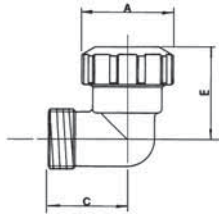

Racor "L" codo macho con bridas

"L" male elbow connector with flanges



R	A	C	E
2 1/2"x75	135	95	111
3"x90	154	107	133

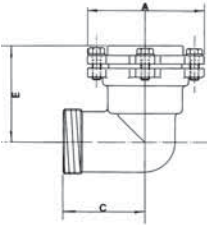

CÓDIGO CODE	MEDIDA SIZE	PESO WEIGHT	CAJA / BOX CARTON	P.V.P. € PRICE €
0040 04	1/2"x20	110	15-240	4,41
0040 05	3/4"x25	165	12-120	5,98
0040 06	1"x32	275	8-80	9,80
0040 07	1 1/4"x40	472	6-72	16,82
0040 08	1 1/2"x50	605	4-48	23,34
0040 09	2"x63	1125	2-24	41,55

0040 10	2 1/2"x75	2125	1-8	85,78
0040 11	3"x90	3270	1-4	126,31

Ref. 0045

● Racor codo hembra

"L" female elbow connector



R	A	C	E
1/2"x20	34	22	38,5
3/4"x25	40	26	45,3
1"x32	50	30	52,3
1 1/4"x40	61	37	62,4
1 1/2"x50	71	42,5	71,4
2"x63	89	51	92,3

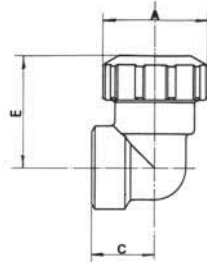

Racor codo hembra con bridas

"L" female elbow connector with flanges



R	A	C	E
2 1/2"x75	135	75	112,8
3"x90	154	107	129,4
4"x110	180	100	157

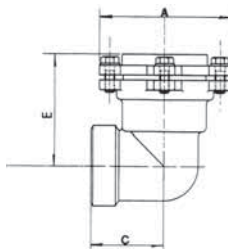

0045 04	1/2"x20	114	15-240	4,21
0045 05	3/4"x25	170	12-192	5,69
0045 06	1"x32	330	8-104	8,91
0045 07	1 1/4"x40	484	6-72	15,42
0045 08	1 1/2"x50	754	4-48	22,07
0045 09	2"x63	1102	2-24	39,61

0045 10	2 1/2"x75	2115	1-8	83,93
0045 11	3"x90	3540	1-8	129,02
0045 12	4"x110	5934	1-4	291,76

Ref. 0050

● Racor "L" codo a compresión

"L" elbow compression connector

R	A	C
20	34	38,5
25	40	45,3
32	50	52,3
40	61	62,4
50	71	72,4
63	89	92,3

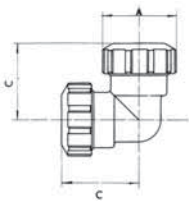

CÓDIGO CODE	MEDIDA SIZE	PESO WEIGHT	CAJA / BOX CARTON	P.V.P. € PRICE €
0050 04	20	130	12-216	5,90
0050 05	25	235	10-100	8,13
0050 06	32	385	6-78	12,99
0050 07	40	670	4-48	21,69
0050 08	50	870	2-36	31,47
0050 09	63	1595	2-14	56,00

● Racor "L" codo con bridas

"L" elbow compression connector with flanges

R	A	C
75	135	115,8
90	154	133,4

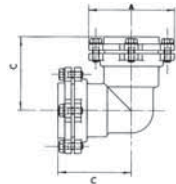

Nota: Para conseguir el racor "L" de 110x110 pedir figura 0045 + 0015.

Note: To obtain "L" connector 110x110" you must request for 0045 and 0015 connector.

0050 10	75	3040	1-8	119,43
0050 11	90	4630	1-4	174,67

Ref. 0048

● Racor "L" codo hembra

"L" female brass elbow

R	A	B	C	D
1/2"X20	22	44	22	18
3/4"X25	25	64	26	21
1"X32	30	71	30	24,5

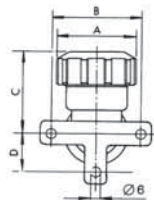

0048 04	1/2"X20	142	15-150	4,78
0048 05	3/4"X25	218	12-156	6,79
0048 06	1"X32	322	8-64	10,41

Ref. 0055

● Boquilla inoxidable

Boquilla inoxidable de refuerzo para la utilización de racores en gas y agua caliente.

Stainless steel nozzle Reinforcement stainless steel nozzle for using gas and hotwater connectors.

R	A	B	C	F
20	18	13,7	31	1
25	24	18,7	36	1
32	31,5	25,7	39	1
40	39	32,2	48	1
50	49	40,4	54	1
63	59,5	51	67	1
75	70	60,7	78,5	1,5
90	84	73,2	86,5	1,5
110	99	88,06	110	2

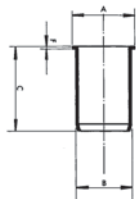

0055 04	20	10	100-2400	1,30
0055 05	25	15	75-2025	1,35
0055 06	32	24	50-1150	1,73
0055 07	40	40	30-420	2,24
0055 08	50	58	20-280	3,29
0055 09	63	92	10-140	4,00
0055 10	75	163	8-104	7,51
0055 11	90	236	6-78	10,15
0055 12	110	400	2-36	36,56

Ref. 0056

● Junta tórica

O'ring



CÓDIGO CODE	MEDIDA SIZE	PESO WEIGHT	CAJA / BOX CARTON	P.V.P. € PRICE €
0056 04	20	-	20	0,40
0056 05	25	-	20	0,49
0056 06	32	-	10	0,54
0056 07	40	-	10	0,59
0056 08	50	-	10	0,71
0056 09	63	-	5	1,19
0056 10	75	-	1	3,04
0056 11	90	-	1	3,72
0056 12	110	-	1	4,19

Ref. 0057

● Anillo junta tórica

lasher ring



0057 04	20	-	20	0,60
0057 05	25	-	20	0,68
0057 06	32	-	10	0,81
0057 07	40	-	10	0,89
0057 08	50	-	5	1,30
0057 09	63	-	5	2,23
0057 10	75	-	1	5,93
0057 11	90	-	1	7,17
0057 12	110	-	1	9,85

Ref. 0058

● Anillo de apriete

Necking



0058 04	20	-	10	1,17
0058 05	25	-	10	1,40
0058 06	32	-	10	1,78
0058 07	40	-	5	3,14
0058 08	50	-	2	3,73
0058 09	63	-	1	5,48
0058 10	75	-	1	9,44
0058 11	90	-	1	12,76
0058 12	110	-	1	27,13



6

CONTADORES DE AGUA WATER METERS

Contadores de agua de chorro único
multiple, volúmetricos, tipo
Woltmann, y contadores de calorías.

*Single or multiple flow, volumetric,
and Woltmann type water metres,
as well as thermic energy meters.*



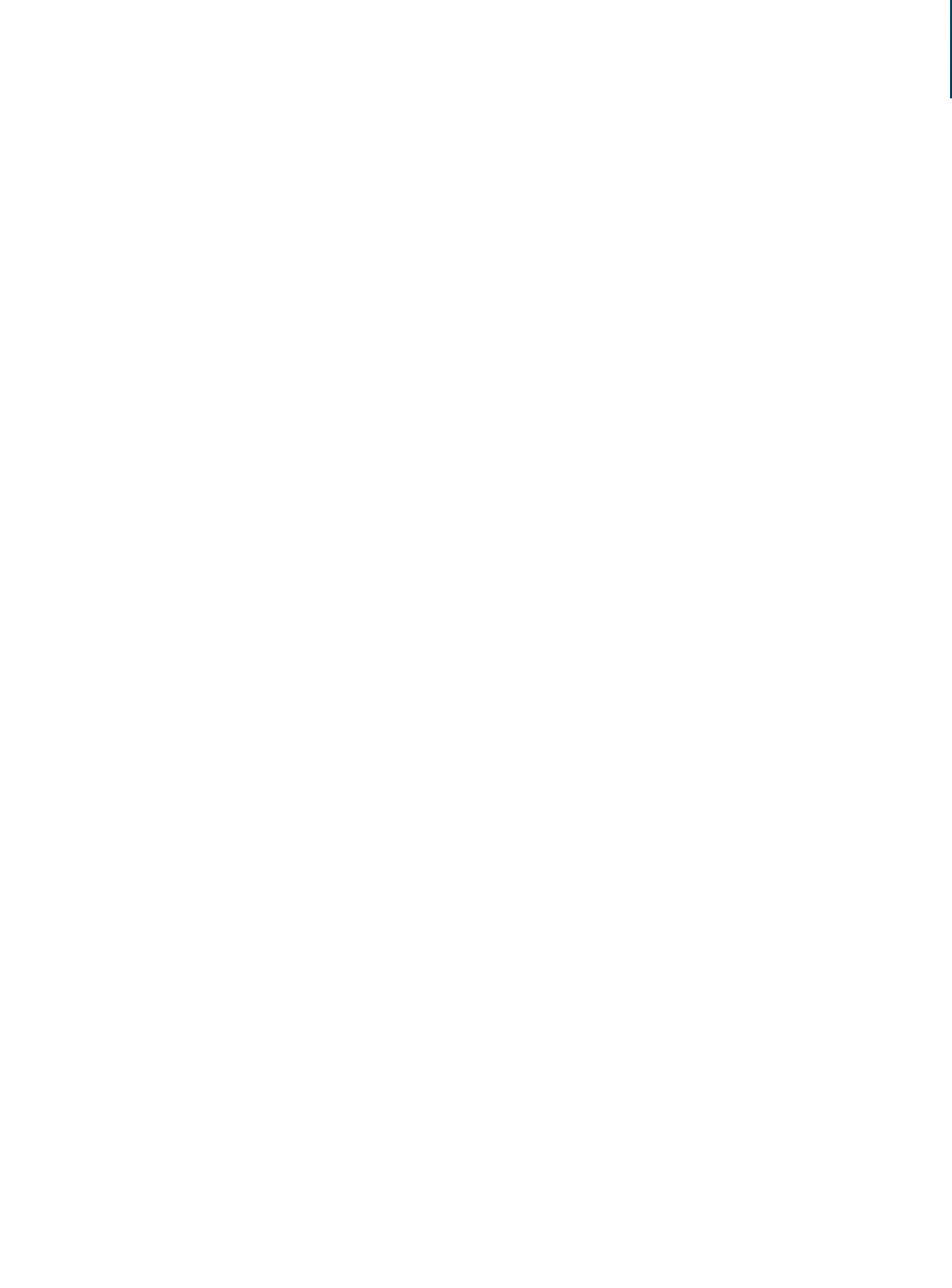

Ref. 6010 - 6015 - 6020



Contador de agua de chorro único "EBRO" (Agua fría)
 Construcción: mecanismo de lectura totalmente seco, por transmisión magnética. Contador orientable a 360°. Montaje horizontal o vertical. Protección contra manipulación. Aprobación CE. Temperatura máxima 30°C. Presión máxima 10bar. Clase de precisión B (montaje horizontal).

"EBRO" Single flow water meter (Cold water)
 Construction: totally dry reading mechanism, by magnetic transmission. Adjustable meter to 360°. Horizontal or vertical mounting. Protected against manipulation. EC approval. Maximum temperature 30°C. Maximum pressure 10bar. Precision class: B (horizontal mounting).

DN	D1	D2	L1	L2	H1	H2
15	3/4"	1/2"	110	39	17	78
13 - 15	3/4" - 7/8"	1/2" - 1/2"	110	39	17 - 21	78
20	1"	3/4"	130	47	21	78

CÓDIGO CODE	MEDIDA SIZE	PESO WEIGHT	P.V.P. € PRICE €
6010 05	3/4" x 3/4"(DN 15)	505	40,51
6015 05	7/8" x 3/4" (DN13-15)	505	40,51
6020 06	1" x 1" (DN20)	530	45,02
6038 04	Racor/ Connector 1/2" x 7/8"	-	7,36
6040 04	Racor/ Connector 1/2" x 3/4"	-	2,34
6040 05	Racor/ Connector 3/4" x 1"	-	3,70

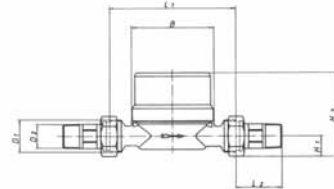

Ref. 6011 - 6021



Contador de agua de chorro único "EBRO" (Agua caliente)
 Construcción: mecanismo de lectura totalmente seco, por transmisión magnética. Contador orientable a 360°. Montaje horizontal o vertical. Protección contra manipulación. Aprobación CE. Temperatura máxima 90°C. Presión máxima 10bar. Clase de precisión B (montaje horizontal).

"EBRO" Single flow water meter (Hot water)
 Construction: totally dry reading mechanism, by magnetic transmission. Adjustable meter to 360°. Horizontal or vertical mounting. Protected against manipulation. EC approval. Maximum temperature: 90°C. Maximum pressure 10bar. Precision class: B (horizontal mounting).

DN	D1	D2	L1	L2	H1	H2
15	3/4"	1/2"	110	39	17	78
20	1"	3/4"	130	47	21	78

6011 05	3/4" x 3/4"(DN 15)	505	49,92
6021 06	1" x 1" (DN20)	530	55,08
6040 04	Racor/ Connector 1/2" x 3/4"	-	2,34
6040 05	Racor/ Connector 3/4" x 1"	-	3,70

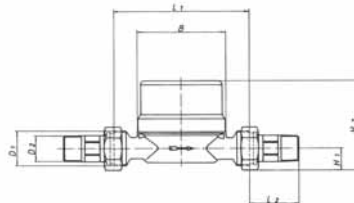

Ref. 6110C - 6120C



NOVEDAD
NEW

Contador de agua de chorro único (Agua fría)
 Construcción: mecanismo de lectura totalmente seco, por transmisión magnética. Contador orientable a 360°. Montaje horizontal o vertical. Protección contra manipulación. Aprobación CE. Temperatura máxima 30°C. Presión máxima 16bar. Clase de precisión 2 (montaje horizontal).

Single flow water meter (Cold water)
 Construction: totally dry reading mechanism, by magnetic transmission. Adjustable meter to 360°. Horizontal or vertical mounting. Protected against manipulation. EC approval. Maximum temperature 30°C. Maximum pressure 16bar. Precision class: 2 (horizontal mounting).

DN	D1	D2	L1	L2	H1	H2
15	3/4"	1/2"	110	47	17	84,5
20	1"	3/4"	130	52	21	84,5

6110C 05	3/4" x 3/4" (DN 15)	650	30,73
6120C 06	1" x 1" (DN 20)	820	38,17

Racor incluido / Included connector

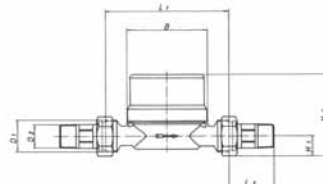

Ref. 6111C - 6121C



Contador de agua de chorro único (Agua caliente)

Construcción: mecanismo de lectura totalmente seco, por transmisión magnética. Contador orientable a 360°. Montaje horizontal o vertical. Protección contra manipulación. Aprobación CE. Temperatura máxima 90°C. Presión máxima 16bar. Clase de precisión 2 (montaje horizontal).

Single flow water meter (Hot water)

Construction: totally dry reading mechanism, by magnetic transmission. Adjustable meter to 360°. Horizontal or vertical mounting. Protected against manipulation. EC approval. Maximum temperature: 90°C. Maximum pressure 16bar. Precision class: 2 (horizontal mounting).

DN	D1	D2	L1	L2	H1	H2
15	3/4"	1/2"	110	47	17	84,5
20	1"	3/4"	130	52	21	84,5

CÓDIGO CODE	MEDIDA SIZE	PESO WEIGHT	P.V.P. € PRICE €
6111C 05	3/4" x 3/4" (DN 15)	650	31,49
6121C 06	1" x 1" (DN 20)	820	38,93

Racor incluido / Included connector

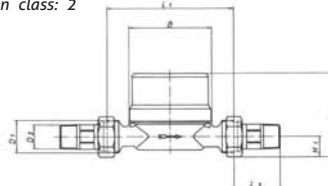

Ref. 6029



Contador de agua de chorro múltiple (Agua fría)

Contador de dial húmedo para agua fría. Montaje horizontal. Aprobación CE. Temperatura máxima 30°C. Presión máxima 16bar. Clase de precisión 2 (montaje horizontal).

Multiple flow water meter (Cold water)

Wet dial meter for cold water. Horizontal mounting. EC approval. Maximum temperature: 30°C. Maximum pressure 16bar. Precision class: 2 (horizontal mounting).

DN	d	D	b1	b2	c	g
15	3/4"	1/2"	165	259	107,5	94
20	1	3/4"	190	294	107,5	94
25	1 1/4"	1"	260	380	117,5	98
32	1 1/2"	1 1/4"	260	384	117,5	98
40	2	1 1/2"	300	431	141,5	122

6029 05	3/4" x 3/4" (DN 15)	1680	57,06
6029 06	1" x 1" (DN 20)	1880	63,36
6029 07	1 1/4" x 1 1/4" (DN 25)	2920	108,78
6029 08	1 1/2" x 1 1/2" (DN 32)	3690	120,24
6029 09	2" x 2" (DN 40)	6140	206,69

Racor incluido / Included connector

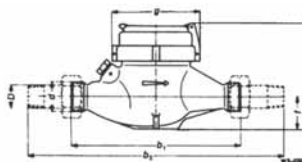

Ref. 6029P



Contador de agua de chorro múltiple (Agua fría)

Construcción: tecnopolímero. Contador de dial húmedo para agua fría. Montaje horizontal. Temperatura máxima 40°C. Presión máxima 16bar. Clase de precisión B (montaje horizontal).

Multiple flow water meter (Cold water)

Construction: plastic body. Wet dial meter for cold water. Horizontal mounting. Maximum temperature: 40°C. Maximum pressure 16bar. Precision class: B (horizontal mounting).

DN	d	D	b1	b2	c	g
15	3/4"	1/2"	165	259	105,5	98
20	1	3/4"	190	294	107	98
25	1 1/4"	1"	260	380	107	98

6029P 05	3/4" x 3/4" (DN 15)	695	35,50
6029P 06	1" x 1" (DN 20)	806	41,99
6029P 07	1 1/4" x 1 1/4" (DN 25)	990	76,34

Racor incluido / Included connector

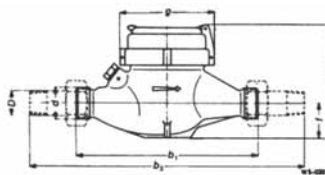

Ref. 6090



Contador de agua volumétrico - piston rotativo (Agua fría)

Aplicación en zonas residenciales. Temperatura máxima 40°C. Presión máxima 16 bar. Clase de precisión C.

Volumetric rotary piston water meter (Cold water)

For residential applications. Maximum temperature 40°C. Maximum pressure 16 bar. Precision class: C.

DN	d	D	b1	b2	c	g
15	3/4"	1/2"	165	259	114	99

6090 05	3/4" x 3/4" (DN 15)	1500	60,23
---------	---------------------	------	-------

Racor incluido / Included connector

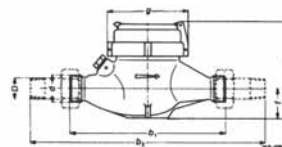

Ref. 6192



NOVEDAD
NEW

Contador de agua volumétrico, piston rotativo (Agua fría)
Aplicación en zonas residenciales. Temperatura máxima 40°C. Presión máxima 16 bar. Clase de precisión C.

Volumetric rotary piston water meter (Cold water)
For residential applications. Maximum temperature 40°C. Maximum pressure 16 bar. Precision class: C.

DN	D	d	L	L1	W
15	3/4"	1/2"	115	209	90
20	1"	3/4"	130	234	96

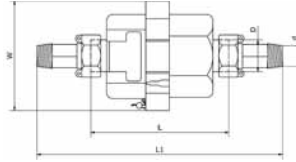

CÓDIGO CODE	MEDIDA SIZE	PESO WEIGHT	P.V.P. € PRICE €
6192 05	3/4" x 3/4" (DN 15)	1130	54,09
6192 06	1" x 1" (DN 20)	1480	-

Racor incluido / Included connector

Ref. 6060



WOLTMANN

Contador de agua tipo WOLTMANN con bridas DIN
Para la medición del consumo de agua fría. Registro seco - transmisión magnética. Pérdida de presión mínima. Precisión de medición conforme a la Norma ISO 4064, clase B (montaje horizontal). Posición de montaje horizontal, vertical o inclinado (se recomienda el montaje en posición horizontal y con el medidor hacia arriba). Condiciones de trabajo: Temperatura máxima del agua: 40°C. Presión máxima de trabajo: 10 bar. Extremos conexión bridas DIN.

Equipado con salida de impulsos

WOLTMANN water meter with DIN flanges
For measurement of high flows of cold water. Dry-dial, magnetic drive. Low pressure loss. Measuring accuracy conform to ISO 4064 Standard, B class (horizontal mounting). The meter can be installed in horizontal - vertical or inclined position (a horizontal position with the register face upwards is recommended). Working conditions: Maximum water temperature: 40°C. Maximum working pressure: 10 bar. DIN flanges ends connection. Pulse output equipped

DN	L (mm)	H (mm)	D (mm)	D1 (mm)	Agujeros / holes (mm)	Peso / Weight (Kg)
50	200	250	165	125	4 x 18	12
65	200	255	185	145	4 x 18	13
80	225	265	200	160	8 x 18	15
100	250	275	220	180	8 x 18	19
125	250	285	245	210	8 x 18	22
150	300	375	285	240	8 x 23	47
200	350	400	340	295	8 x 23	48
250	400	484	395	350	12 x 23	110

CÓDIGO CODE	MEDIDA SIZE	P.V.P. € PRICE €
6060 09	DN50 Bridas 2"/ DN50 Flanges 2"	257,66
6060 10	DN65 Bridas 2 1/2"/ DN65 Flanges 2 1/2"	280,57
6060 11	DN80 Bridas 3"/ DN80 Flanges 3"	291,96
6060 12	DN100 Bridas 4"/ DN100 Flanges 4"	366,60
6060 13	DN125 Bridas 5"/ DN125 Flanges 5"	439,39
6060 14	DN150 Bridas 6"/ DN150 Flanges 6"	602,97
6060 16	DN200 Bridas 8"/ DN200 Flanges 8"	717,41
6060 18	DN250 Bridas 10"/ DN250 Flanges 10"	1541,85

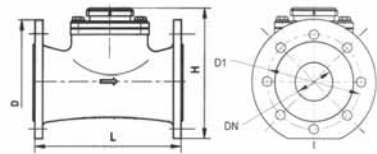

Ref. 6060A



Contador de agua tipo WOLTMANN con bridas ANSI
Para la medición del consumo de agua fría. Registro seco - transmisión magnética. Pérdida de presión mínima. Precisión de medición conforme a la Norma ISO 4064, clase B (montaje horizontal). Posición de montaje horizontal, vertical o inclinado (se recomienda el montaje en posición horizontal y con el medidor hacia arriba). Condiciones de trabajo: Temperatura máxima del agua: 40°C. Presión máxima de trabajo: 10 bar. Extremos conexión bridas ANSI. Equipado con salida de impulsos

WOLTMANN water meter with ANSI flanges
For measurement of high flows of cold water. Dry-dial, magnetic drive. Low pressure loss. Measuring accuracy conform to ISO 4064 Standard - B class (horizontal mounting). The meter can be installed in horizontal, vertical or inclined position (a horizontal position with the register face upwards is recommended). Working conditions: Maximum water temperature: 40°C. Maximum working pressure: 10 bar. ANSI flanges ends connection. Pulse output equipped

DN	L (mm)	H (mm)	D (mm)	D1 (mm)	Agujeros / holes (mm)	Peso / Weight (Kg)
2"	200	256	152,4	120,6	4 x 19	12
2 1/2"	200	266	177,8	139,7	4 x 19	13
3"	225	276	190,5	152,4	4 x 19	16
4"	250	286	228,6	190,5	8 x 19	18
5"	250	299	254	215,9	8 x 22	20
6"	300	346	279,4	241,3	8 x 22	42
8"	350	373	298,5	298,5	8 x 22	64
10"	450	493	362	362	12 x 25	94

CÓDIGO CODE	MEDIDA SIZE	P.V.P. € PRICE €
6060A 09	DN50 Bridas 2"/ DN50 Flanges 2"	257,66
6060A 10	DN65 Bridas 2 1/2"/ DN65 Flanges 2 1/2"	280,57
6060A 11	DN80 Bridas 3"/ DN80 Flanges 3"	291,96
6060A 12	DN100 Bridas 4"/ DN100 Flanges 4"	364,02
6060A 13	DN125 Bridas 5"/ DN125 Flanges 5"	439,39
6060A 14	DN150 Bridas 6"/ DN150 Flanges 6"	602,97
6060A 16	DN200 Bridas 8"/ DN200 Flanges 8"	717,41
6060A 18	DN250 Bridas 10"/ DN250 Flanges 10"	1541,85

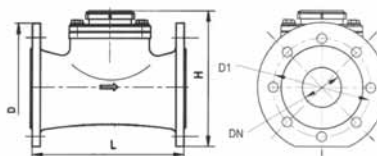

Ref. 6066

Emisor de impulsos para Woltman

Sensor de contacto libre de potencial. Cable de 2 hilos por 1, 5 m de longitud.



NOVEDAD
NEW

Woltman Pulse transmitter

Switch sensor potential free. 2 wire cable and 1, 5 m length.

CÓDIGO CODE	MEDIDA SIZE	P.V.P. € PRICE €
6066	-	20,83

Ref. 6085

Contador de calorías

Los contadores de energía térmica de tipo compacto se utilizan para la contabilización del consumo de la energía térmica en aplicaciones de calefacción. Compuesto de unidad de cálculo de consumo energético, display de visualización de 8 dígitos, teclado de interacción usuario, contador de chorro único con la sonda de retorno insertada en el propio cuerpo del contador y sondas PT500 Ø5 mm. Red de comunicación M-bus. Certificado MID (2004/22/CE).



Instalación del contador en la tubería de retorno. Montaje en horizontal o vertical. PN10 bar. IP54. Alimentación por batería de litio 3V. Longitud del cable sonda 1,5m. Rango de temperatura de fluido desde 15°C a 90°C.

Thermic energy meter

The compact thermic energy meters are used to score the thermic energy consumption in a heating instalations. Components: Energetic consumption calculation unit, 8 digits display, keyboard user, single jet meter with return probe inserted into the body's meter and PT500 Ø5mm. probes. M-bus communication net. MID (2004/22/CE) Certificcate.

Meter installation on the return pipe. Horizontal or vertical mounting. PN10 bar. IP54. Lithium battery power supply. 1,5m probe cable length. Flow temperatures range from 15°C to 90°C.

6085 05	Contador de calorías DN15 - 3/4" Thermic energy meter DN15 - 3/4"	375,06
6085 06	Controlador de calorías DN20 - 1" Thermic energy meter DN20 - 1"	392,12

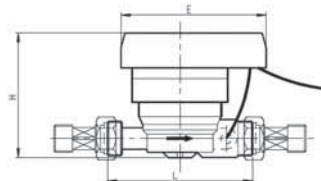

Tamaño / Size (DN)	Caudal / Flow Rate			Longitud / Length L (mm.)	Altura / Height H (mm.)	Unidad cálculo / Compute unit E (mm.)	Rosca Sonda Probe Thread	Longitud sonda Probe Length (mm)
	Q Max. m³/h	Q m³/h	Q Min. l/h					
3/4" (15 mm.)	3	1,5	7	110	95	110 (110 x 80)	M10x1	35
1" (20 mm.)	5	2,5	10	130	97,5		M10x1	35

Ref. 6045

Tapa contador EBRO

EBRO meter cover



6045 00	-	3,27
---------	---	------

Ref. 6040 - 6038

Racor con junta

Connector with joint



6040 04	Racor/ Connector 3/4" x 1/2"	2,34
6040 05	Racor/ Connector 1" x 3/4"	-
6040 06	Racor/ Connector 1 1/4" x 1"	12,87
6040 07	Racor/ Connector 1 1/2" x 1 1/4"	15,37
6040 08	Racor/ Connector 2" x 1 1/2"	23,91
6038 04	Racor/ Connector 7/8" x 1/2"	7,36

Ref. 6041

Adaptador

Adaptor



6041 05	Adaptador 3/4" x 7/8" / Adaptor 3/4" x 7/8"	0,79
---------	---	------

CONDICIONES GENERALES DE VENTA

PRECIOS: Los precios se entienden en nuestro almacén, siendo los portes, el I.V.A. y acarreo a cargo del comprador, salvo acuerdo previo en contra.

CONDICIONES DE PAGO: En aplicación de la Ley 15/2010 que limita los plazos máximos de pago en las operaciones comerciales, hemos ajustado las condiciones a lo dispuesto en la misma. En caso de diferirse el pago, los gastos de negociación de efectos y/o los intereses legales especificados serán a cargo del comprador. El impago de cualquier efecto o recibo, conllevará la inmediata suspensión de suministros y servicios.

PEDIDOS: Para la tramitación de cualquier suministro será indispensable que el comprador nos remita el pedido por escrito indicando claramente la referencia Genebre, incluidos los dígitos de la medida y también la cantidad deseada en base a las unidades de compra mínima (por caja), tal como especifica Genebre en su catálogo. Si existen condicionantes no previstos, Genebre S.A. se reserva el derecho de aceptación o anulación de los pedidos cursados. Cada pedido solicitado a Genebre S.A. genera una expedición para el cliente con su coste de transporte correspondiente; por lo que recomendamos preparen sus pedidos completos una vez al día para optimizar el transporte. Todos los pedidos serán confirmados por Genebre, S.A. vía email/fax. Salvo notificación de lo contrario en las siguientes 24 horas, el pedido confirmado seguirá su curso sin derecho a posteriores reclamaciones.

TARIFAS DE PRECIOS: Genebre S.A. comunicará a sus clientes cualquier cambio que se produzca en las tarifas del catálogo a través de alguna de las vías de comunicación usuales (web, email, correo).

CANCELACIÓN DE PRODUCTOS DE CATALOGO: Genebre, S.A. comunicará a sus clientes cualquier cancelación de productos del catálogo.

ESPECIFICACIONES TÉCNICAS: El catálogo de Genebre, S.A. contiene los requisitos técnicos y normas aplicables a los productos suministrados. Genebre S.A. se reserva la facultad de cambiar en todo o en parte el diseño y materiales de cualquiera de sus productos, debido a la mejora continua de nuestros productos.

EXPEDICIONES: Todo pedido superior a 500 euros en Península se suministran a portes pagados. Para Canarias, Ceuta, Melilla y Andorra, el pedido mínimo será de 1.000 euros. Las mercancías viajan siempre por cuenta y riesgo del comprador, aún en los casos de convenios especiales.

ENTREGA: Los pedidos se suministrarán siempre por cajas completas, según especificaciones de catálogo.

RECLAMACIONES: Las eventuales reclamaciones deberán formularse dentro de los 15 días siguientes al de recepción de la mercancía por el comprador, rechazándose las efectuadas después de dicho plazo límite. NO se aceptará ninguna devolución de material sin aprobación previa de nuestro Departamento Comercial que facilitará un número de boletín de devolución que debe acompañar al material devuelto. Todas las devoluciones serán con los portes a cargo del comprador. Y se realizará un cargo por demérito del 10% del valor de la mercancía para todos los materiales, excepto para las válvulas automatizadas que será del 30%.

GARANTIA: Queda limitada al reemplazo de las piezas reconocidas como defectuosas de fabricación por el Departamento de Calidad de Genebre S.A.. No admitiremos ninguna reclamación transcurridos 15 días de la recepción de la mercancía por el comprador.

PROPIEDAD DE LA MERCANCÍA: Genebre, S.A. se reserva el derecho de propiedad de la mercancía suministrada, hasta que el comprador no haya satisfecho totalmente el importe de la misma. En el intervalo, se considerará en concepto de depósito y custodia. La mercancía podrá ser retirada por incumplimiento de pago en el plazo previamente estipulado.

LITIGIOS: En caso de litigio, ambas partes aceptan someter sus diferencias a los Juzgados de L'Hospitalet de Llobregat.

GENERAL SALES CONDITIONS

PRICES: Prices are considered to be EX WORKS, being the freight and transportation at the cost of the purchaser, unless previous agreement has been reached.

PAYMENT TERMS: We have adjusted the conditions in application of Law 15/2010 which limits the maximum terms of payment in commercial transactions. The maximum delay on payment will be of 60 days after invoice date. Payment term will be as accorded between the parties. In case of unpaid, the expenses and interest occurred will be paid by the purchaser. The unpaid maturity will imply the compete suspension of any service or supply.

ORDERS: Regarding the handling of any supply, it is compulsory for the purchaser to send a written signed and sealed purchasing order indicating clearly Genebre's reference, including measures digits, and also the quantity required according to obligated minimum units of purchase (boxes), as Genebre's Catalogue specifies. In case of unexpected discrepancies, Genebre has the right to accept or cancel the pending orders. Each order required to GENEBRE, S.A., opens a client expedition with corresponding transports cost, because of that, we recommend to prepare complete orders once a day to improve the transport. All the orders will be confirmed by GENEBRE by e-mail/fax. Each confirmed order will handled without any right from the purchaser to modify it, unless previous notification before 24 hours after confirmation.

PRICE LIST: GENEBRE will inform the customers about any change in the price list, using some usual communication way (web, e-mail or post).

PRODUCTS WITHDRAWAL FROM CATALOGUE: Genebre S.A. will inform the customers about any product withdrawal from the catalogue.

TECHNICAL SPECIFICATIONS: GENEBRE's catalogue holds all the technical requirements and applicable norms about the products.

SHIPMENT: Goods are shipped under the purchaser's own risk, even in special cases.

DELIVERY: Orders will always be shipped according to full boxes, as specified in the catalogue.

CLAIMS: Eventual claims must be done within 15 days after date of reception of the goods by the purchaser. Claims after such period will not be considered. NO devolution will be accepted without the previous approval from our Sales Department, who will issue a devolution certificate that must be enclosed in the devolution goods. All devolutions' freight will be paid by the purchaser. Additionally, an unworthiness debit of 10% of the products' value will be charged, except for the automatic valves that are a 30%.

GUARANTEE: It is limited to defective pieces replacement identified by GENEBRE's Quality Department. We will not accept any return after 15 days from the date of reception by the purchaser.

PROPERTY OF THE GOODS: GENEBRE has the property right of the supplied goods, until the purchaser has totally paid its value. In the meantime, it will be considered as deposit and custody. Goods shall be claimed in case of breach of payment terms.

DISPUTES: In case of disputes, both parties agree to solve discrepancies in the Barcelona Court of Justice.



GENEBRE

EDIFICIO GENE BRE.

Av. de Joan Carles I , 46-48

08908 L'Hospitalet de Llobregat.

Barcelona (Spain)

www.genebre.es

