

The logo for Genebre, featuring a stylized 'G' followed by the word 'NEBRE' in a bold, sans-serif font.

Be water, Be Genebre

Colección Grifería

Cocina y Baño

Tap Collection

Kitchen & Bathroom

2017 18

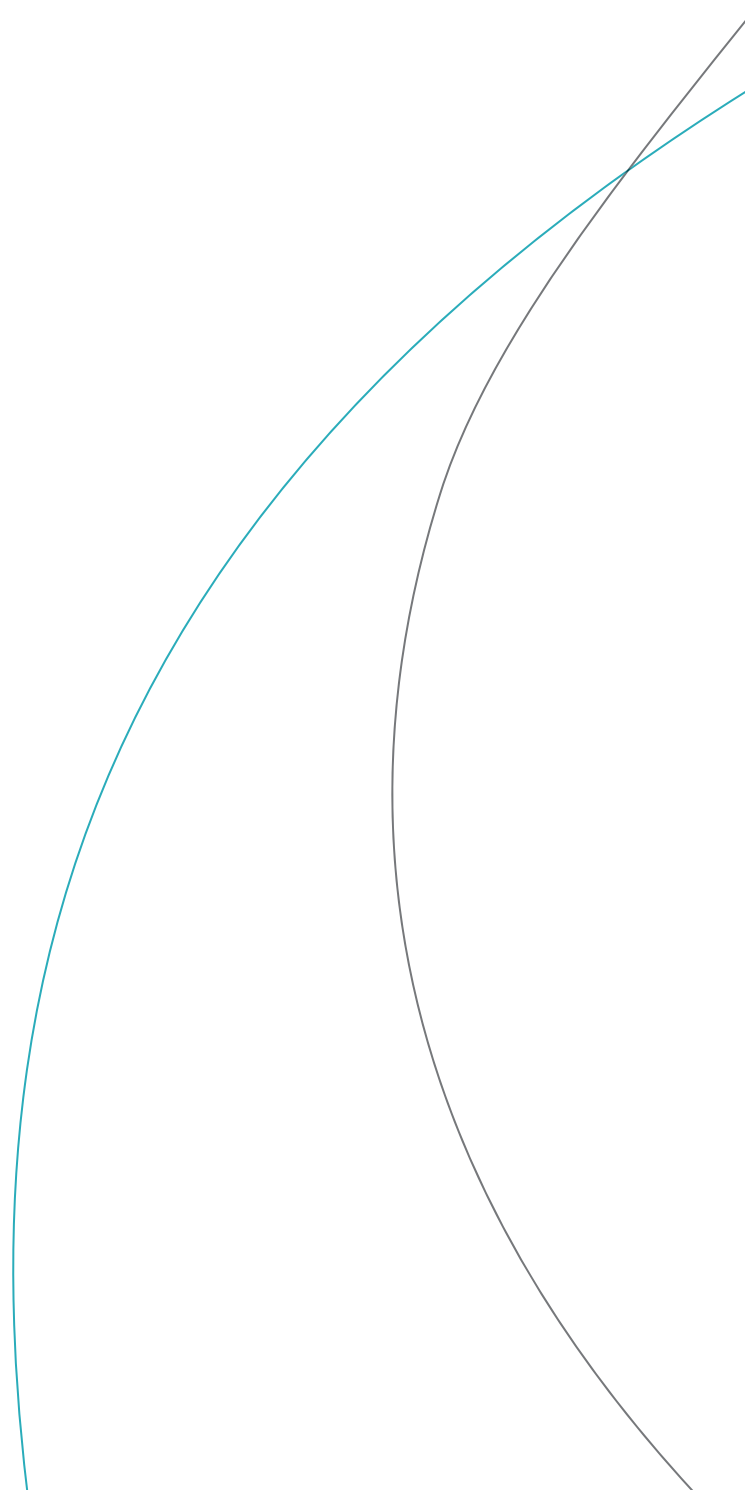

Contacto Contact

Genebre Group

Edificio Genebre
Avda. Joan Carles I, 46-48
Distrito económico de l'Hospitalet
08908 l'Hospitalet de Llobregat
Barcelona (SPAIN)
Teléfono / Phone +34 93 298 80 00
www.genebre.es

Contacto comercial Commercial contact

España / Spain
Teléfono / Phone +34 93 298 80 01
Fax: + 34 93 298 80 06
griferia@genebre.es

Europa / Europe
Teléfono / Phone +34 93 298 80 15

Europa este / East Europe
Teléfono / Phone +34 93 298 80 19

América latina / Latin America
Teléfono / Phone +34 93 298 80 17

América del norte / North America
Teléfono / Phone +34 93 298 80 00
Fax: + 34 93 298 80 08

www.genebre.com
exportacion@genebre.es

Otros teléfonos Other general telephone numbers

Centralita / Central telephone number
Teléfono / Phone +34 93 298 80 00

Administración / Administration
Teléfono / Phone +34 93 298 80 02
Fax: + 34 93 298 80 07

**Servicio de atención técnica al cliente /
Technical support**
Teléfono / Phone +34 902 504 203

Colección Collection

Tan adaptables como el agua

Tenemos el placer de presentarte nuestra nueva colección de grifería. Una búsqueda de nuevos conceptos y tendencias que fusiona la elegancia, la tecnología y los más altos estándares de calidad. Líneas minimalistas, robustas y de gran belleza que armonizan con la versatilidad y el uso responsable del agua. Infinidad de modelos, acabados y sistemas que, además de crear exquisitos ambientes en baños y cocinas, aumentan el bienestar y ayudan a cuidar el medio ambiente. El resultado: una colección tan adaptable como el agua, en la que cada diseño es especial y único.

As adaptable as water

We are pleased to introduce our new collection of taps to you. A search for new concepts and trends that mix elegance, technology and the highest quality standards. Beautiful, robust, minimalist lines offer versatility combined with the responsible use of water. An infinity of models, finishings and systems which enhance well-being and help to protect the environment, in addition to creating exquisite ambiances in bathrooms and kitchens. The result: a collection as adaptable as water itself, in which each design is special and unique.

Índice Index

Kode	10
Oslo	16
Klip	24
Klip 2	32
Kelogic	38
Tau	46
Tau 2	66
Kenjo	72
Inox	82
K8	86
Ge2	96
New Regent Classic	104
New Regent	110
Gamma	120
Kalo	130
Kross	136
Ixo	142
Style Shower	148
Accesorios / Accessories	158
Recambios / Spare parts	176
Información técnica Technical information	188
Índice por referencia Index by reference	248

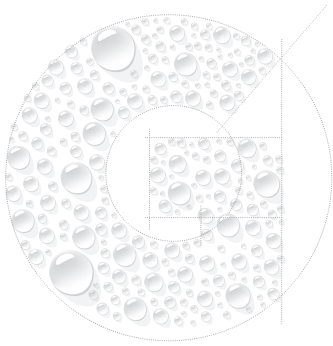

Be water, be Genebre

El agua es la esencia de la vida

El agua es un bien fundamental para la vida y el planeta, pero también un recurso escaso y limitado cuyo consumo va en aumento. Estamos acostumbrados a verla correr y, hasta hace poco, se creía inagotable. Sin embargo, hoy sabemos que la mayor parte del agua de la Tierra es salada o se encuentra en forma de casquetes polares o glaciares, y solo una pequeña parte es útil para los procesos vitales del planeta. De modo que para su conservación en el futuro se necesita una actitud responsable diaria y una mayor conciencia ambiental de cada uno de nosotros. Podemos soñar con un futuro más sostenible, pero para que este sueño se haga realidad debemos empezar desde el presente. Desde hoy.

Water is the essence of life

Water is an essential resource for life and for the planet. At the same time, water is also scarce and limited. In our minds, water is always running, and until recently, it was thought to be in endless supply. However, its usage is increasing. Today we know that most of the water on Earth is salt water, or is found in the form of glaciers or ice caps, and only a small part is usable for the planet's vital processes. Therefore, to conserve water for the future, each and every one of us needs to have a responsible attitude towards it, as well as greater environmental awareness. We can dream about a more sustainable future, but in order to make this dream a reality, we have to start now. Starting today.

Medio ambiente Environment



Promoviendo la sensibilidad y el respeto por el medioambiente

GENEBRE es una compañía comprometida con el medioambiente. Su visión de un futuro sostenible y una filosofía enfocada en proteger el agua y los fluidos le permiten mejorar, investigar, desarrollar y crear conceptos innovadores a partir de las tecnologías más punteras. De manera que aplica siempre criterios que transmitan valores ecológicos en todos sus productos y a la vez que satisfagan las necesidades de funcionalidad, confort y diseño de los usuarios.

Actualmente GENE BRE está colaborando en el programa de I+D NUESVAL. Un estudio coordinado por el Centro Tecnológico de Manresa cuyo objetivo es desarrollar nuevas aleaciones de latón para válvulas de conducción de fluidos en condiciones ambientales de alta temperatura. Un modelo de proyecto basado en la innovación, en el que GENE BRE ha depositado su compromiso empresarial, con el fin de desarrollar tipos específicos de válvulas destinadas tanto a instalaciones domésticas como industriales.

Promoting respect for the environment

GENEBRE is a company committed to the environment. Its vision of a sustainable future and a philosophy focused on protecting water and fluids allow it to improve, research, develop and create innovative concepts using the most advanced technologies. GENE BRE always applies the same criteria which transmits ecological values in all of its products, and at the same time satisfies the users' needs of functionality, comfort, and design.

Currently, GENE BRE is collaborating in the NUESVAL R+D program, a study coordinated by the Centro Tecnológico de Manresa, whose objective is to develop new brass and bronze alloy for valves. It is a project model based on innovation, in which GENE BRE reinforces its commitment to developing specific types of valves for domestic as well as industrial installations.

Calidad Quality

La grifería GENE BRE está diseñada y fabricada según los estándares europeos de calidad, como la UNE-EN 19703 ofreciendo así al cliente la funcionalidad, durabilidad y seguridad esperadas.

El latón empleado en nuestros cuerpos y componentes pertenece a las aleaciones CC754S según norma EN 1982 y CW617N según norma EN 12165.

Las superficies cromadas cumplen la norma EN 248, resistencia a la niebla salina 5% (NaCl), Ph 6,5 T 36°C. según ISO 9227.

Los atomizadores cuentan con casquillos en latón cromado resistente a la corrosión y cartucho aireador en plástico anti calcáreo, según lo especificado en la norma EN 246.

Utilización de cartuchos mezcladores con discos cerámicos de alta calidad fabricados en Al₂O₃ 99%, según normas EN 200 y NF 077 capaces de resistir más de 200.000 maniobras y ofrecer la suavidad y estanqueidad originales.

Los sistemas de giro de los caños han sido fabricados según norma EN 817, siendo capaces de resistir más de 80.000 maniobras.

Empleamos válvulas anti retorno en mezcladores termostáticos según norma EN1717 a fin de asegurar la no intercomunicación.

Todos los cartuchos termostáticos están dotados de un sistema de seguridad anti escaldamiento según norma EN 1111.

Nuestros mangos de ducha están fabricados según norma EN 1112 y los Flexos de ducha fabricados según norma EN 1113.

Las Conexiones flexibles según norma UNE EN 13618.

A fin de asegurar el cumplimiento de estas normas la empresa GENE BRE posee diferentes certificaciones: ISO 9001 Sistema de Gestión de la Calidad. ISO 14001 Sistema de Gestión Ambiental.

GENE BRE posee productos homologados por el Ministerio de Industria y Energía de España.

Conexiones usadas en nuestros productos fabricadas según UNE EN 13618 Certificación de mecanismos y componentes en laboratorios acreditados por ENAC.

GENE BRE posee productos certificados por el Laboratorio Oliver Rodés, confirmando el cumplimiento de los criterios sanitarios de la calidad del agua para el consumo humano RD 140/2003 de 07 de febrero (legislación española) y de la directiva europea relativa a la calidad de las aguas destinadas del consumo humano.

La garantía de los productos GENE BRE está mundialmente reconocida.

Ofrecemos un servicio de asistencia técnica, así como de resolución de incidencias.

GENE BRE's taps are designed and manufactured in compliance with European standards, such as UNE-EN 19703, to comply with and exceed the European Product Directives, thereby offering customers the desired functionality, durability and safety.

The brass used for our taps and components is according to CC754S alloy, in compliance with standard EN 1982 and CW617N alloy in compliance with standard EN 12165.

Chromed surfaces are in compliance with EN 248, resistant to 5% salt spray (NaCl), PH 6.5 T 36°C, in compliance with standard ISO 9227.

Aerators have chrome-plated brass casings resistant to corrosion and plastic anti-lime scale aerator cartridges, in compliance with standard EN 246.

Use of mixing cartridges with high-quality ceramic discs manufactured in Al₂O₃ 99%, in compliance with standards EN 200 and NF 077 capable of withstanding more than 200,000 manoeuvres and offering the original softness and water tightness.

The rotation systems of the water spouts have been manufactured in compliance with standard EN 817 and are capable of withstanding more than 80,000 manoeuvres.

We use anti-backflow valves in thermostatic mixers in compliance with standard EN1717 to ensure there is no backflow.

All thermostatic cartridges are fitted with an anti-scalding security system in compliance with standard EN 1111.

Our handshowers are manufactured in compliance with standard EN 1112 and the Shower hoses are manufactured in compliance with standard EN 1113. The flexible connections in compliance with standard UNE EN 13618.

By means of ensuring these standards are complied with, the company GENE BRE hold different certifications: ISO 9001 Quality management system and ISO 14001 Environmental management system.

GENE BRE owns products approved by the Spanish Ministry of Industry and Energy.

Connections used in our products manufactured according to UNE 13618.

Certification of mechanisms and components in ENAC-accredited laboratories.

GENE BRE owns products certified by the Laboratory Oliver Rodés, confirming compliance with the sanitary criteria for the quality of water for human consumption RD 140/2003 dated 7 February (Spanish legislation) and European Directive relating to the quality of water intended for human consumption. The guarantee of GENE BRE's products is internationally recognized.

We provide a technical assistance service, as well as an incident resolution service.



CE 0035

Tecnología Technology

Presentamos los nuevos sistemas que incorporan las diferentes griferías de GENE BRE para ahorrar en el gasto de agua y energía. Novedades diseñadas especialmente para facilitar el uso y a su vez hacerlo más seguro y medioambientalmente sostenible.

The following user-friendly systems include the different GENE BRE taps that make for safer and more environmentally sustainable use, leading to financial savings in water expenditure and/or domestic energy.



GE-ECO

Sistema GE-ECO economizador de agua, basado en la limitación de caudal del grifo el cual, a su vez, también nos ayudará a ahorrar energía. Indicado cuando queremos una restricción constante de agua.

Water economiser system based on limiting the tap flow to help save energy. Especially useful for a permanent control of water consumption.



GE-2P

Sistema economizador de agua basado en la apertura de la maneta del grifo en dos posiciones, una primera posición con un ahorro del 50% de agua y una segunda posición a pleno caudal. Indicado para usos donde queremos controlar qué tipo de caudal del grifo queremos o necesitamos.

Water economiser system based on the two-position opening of the tap. The first position supplies 50% less water and the second supplies the full flow. The system helps provide awareness as to the need to reduce water consumption, yet allowing for the option to use the maximum flow of the tap.





GE-COLD START

Para los que buscan el máximo ahorro, el sistema GE-COLD START de ahorro de agua y energía se basa en la apertura siempre en agua fría, lo que se traduce en un gran ahorro energético al evitar que su caldera, calentador o termo eléctrico entre en funcionamiento indebidamente.

Water and energy-saving system based on cold-water position tap opening, which saves a great deal of energy by stopping your boiler, heater or electric water heater from starting up unnecessarily. System recommended for those wanting to save the maximum amount of energy.

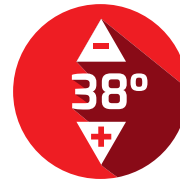

GE-SAFE

Sistema GE-SAFE de seguridad para grifería mezcladora termostática que limita a 38° el caudal de agua caliente, y que asegura el corte del agua para evitar quemaduras en caso de fallo del suministro de agua fría. Incluido en todos nuestros mezcladores termostáticos.

Safety system for thermostatic mixer taps that limits and ensures hot water cuts off at a maximum temperature of 38°C, avoiding burns in the event of a cut in the cold-water supply. This system is built into all our thermostatic mixer taps.



Kode

Ligereza compacta

Las tendencias de los baños de última generación inspiran el diseño de alta gama de esta colección Kode. Su maneta contundente y compacta, se aligera a través del dinamismo de sus líneas curvas y formas redondeadas. Un estilo robusto y estilizado que no te dejará indiferente.

Compact lightness

The top-class design of this Kode collection is inspired by state-of-the-art bathroom trends. Its robust and compact handle is lightened by its dynamic curves and rounded shape. A robust and slender style that will impress you.

Acabado cromado. Cartucho 40
Chromed finish. Cartridge 40

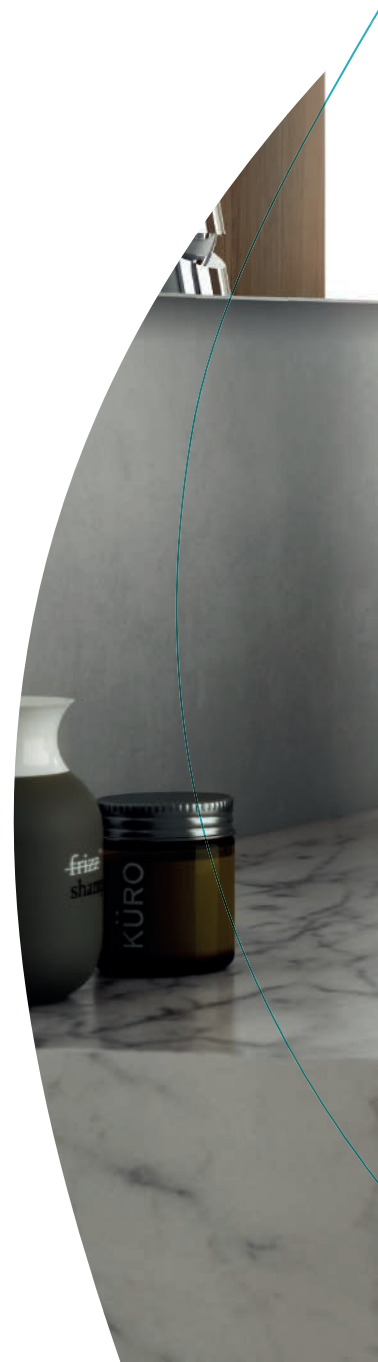



Kode | Monomando lavabo | Single lever wash-basin mixer



Ref.: 62130 08 45 66
Monomando de lavabo
Single lever wash-basin mixer
Cartucho 2 posiciones | 2 position cartridge



Ref.: 62136 08 45 66
Monomando de lavabo alto
High single lever wash-basin mixer
Cartucho 2 posiciones | 2 position cartridge



Kode | Lavabo empotrado | Built-in single lever wash-basin mixer



Ref.: 62131 31 45 66
Monomando de lavabo empotrado caño 16 cm
Built-in wash-basin mixer 16 cm spout



Ref.: 62132 31 45 66
Monomando de lavabo empotrado caño 22 cm
Built-in wash-basin mixer 22 cm spout



Kode | Monomando bidé | Single lever bidet mixer



Ref.: 62140 08 45 66
 Monomando de bidé
 Single lever bidet mixer

Cartucho 2 posiciones | 2 position cartridge



Ref.: 62142 31 45 66
 Monomando de bidé con transmisión
 Single lever bidet mixer with diverter

Kode | Baño y ducha | Bath & shower



Ref.: 62100 08 45 67
 Monomando de baño sin kit
 Single lever bath mixer without kit

Cartucho 2 posiciones | 2 position cartridge



Ref.: 62110 31 45 67
 Monomando de ducha sin kit
 Single lever shower mixer without kit

Cartucho 2 posiciones | 2 position cartridge



Ref.: DXO3 45
 Mango de ducha O3 jets
 O3 jets handshower

Ref.: 100137 60 00
 Flexo extensible H 1/2" - H 1/2" 1,70 - 2,25 m
 inoxidable
 F 1/2" - F 1/2" Extensible stainless steel flexible
 hose 1.70 to 2.25 m

Ref.: 100068 45
 Soporte ducha ovalado
 Oval shower holder

Kode | Empotrados | Built-in single lever bath & shower mixers



Ref.: 62115 31 45 66
 Monomando de ducha empotrado
 Built-in single lever shower mixer



Ref.: 62117 31 45 66
 Monomando empotrado con inversor cerámico 2 vías
 Built-in single lever mixer with 2 way ceramic diverter



Ref.: 62118 31 45 66
 Monomando empotrado con inversor cerámico 3 vías
 Built-in single lever mixer with 3 way ceramic diverter

Kode | Inversor | Diverter



Ref.: 62114 30 45 66
 Inversor cerámico 3 vías empotrado con placa ovalada
 Built-in 3 way ceramic diverter with oval plate



Kode | Style shower



Ref.: 62114 30 45 66

Inversor cerámico 3 vías empotrado con placa ovalada

Built-in 3 way ceramic diverter with oval plate

Ref.: 62115 31 45 66

Monomando de ducha empotrado

Built-in single lever shower mixer

Ref.: 1643 45

Rociador doble función cascada-lluvia

Shower head double function waterfall-rain

Ref.: 1680 04

Toma ducha mural redonda

Round wall flexible connector

Ref.: 1636 45

Barra ducha TAU

TAU shower bar

Ref.: 100137 60 00

Flexo extensible H 1/2" - H 1/2" 1,70 - 2,25 m inoxidable

F 1/2" - F 1/2" Extensible stainless steel flexible hose 1.70 to 2.25 m

Ref.: DXO3 45

Mango de ducha O3 jets

O3 jets handshower



Ref.: 62118 31 45 66

Monomando empotrado con inversor cerámico 3 vías

Built-in single lever mixer with 3 way ceramic diverter

Ref.: B65113 18

Brazo pared redondo 35 cm

Round wall arm 35 cm

Ref.: R63112 08

Rociador ovalado 22 cm

Oval shower head 22 cm

Ref.: 1680 04

Toma ducha mural redonda

Round wall flexible connector

Ref.: 1636 45

Barra ducha TAU

TAU shower bar

Ref.: 100137 60 00

Flexo extensible H 1/2" - H 1/2" 1,70 - 2,25 m inoxidable

F 1/2" - F 1/2" Extensible stainless steel flexible hose 1.70 to 2.25 m

Ref.: DXO3 45

Mango de ducha O3 jets

O3 jets handshower

Ref.: 1668 45

Caño mural baño cilíndrico

Round wall bath spout

Oslo

Simplicidad vanguardista

Formas puras, ángulos rectos y un atrevido diseño que transmite un estilo diferente y vanguardista, donde todos los detalles han sido cuidadosamente calculados para recrear un ambiente bello y elegante. Descubre sus diferentes alturas de finos y esbeltos caños, y elige el que mejor se adapte a tu estilo.

Avant-garde simplicity

Pure shapes, right angles and a daring design that transmits a different and avant-garde style, where every detail is carefully calculated to create a beautiful and elegant ambiance. Discover its thin and slender spouts in different heights, and choose one that best suits your style.

Acabado cromado. Cartucho 35
Chromed finish. Cartridge 35

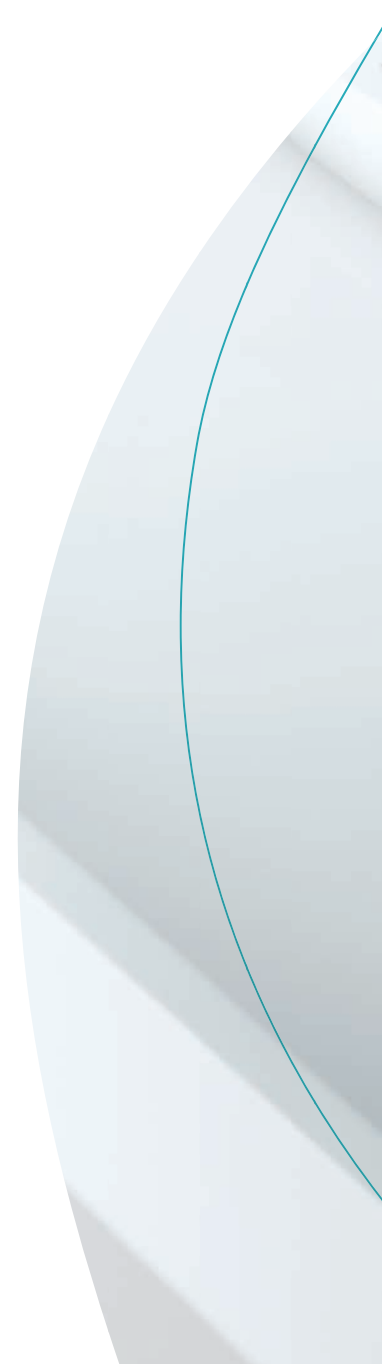



Oslo | Monomando lavabo | Single lever wash-basin mixers



Ref.: 65130 19 45 66
 Monomando de lavabo
 Single lever wash-basin mixer
Cartucho 2 posiciones | 2 position cartridge



Ref.: 65134 19 45 66
 Monomando de lavabo medio alto
 Medium height single lever wash-basin mixer
Cartucho 2 posiciones | 2 position cartridge



Ref.: 65136 19 45 66
 Monomando de lavabo alto
 High single lever wash-basin mixer
Cartucho 2 posiciones | 2 position cartridge



Oslo | Lavabo empotrado | Built-in single lever wash-basin mixers



Ref.: 65131 19 45 66
 Monomando de lavabo empotrado caño 16 cm
 Built-in wash-basin mixer 16 cm spout



Ref.: 65132 19 45 66
 Monomando de lavabo empotrado caño 22 cm
 Built-in wash-basin mixer 22 cm spout



Oslo | Monomando bidé | Single lever bidet mixers



Ref.: 65140 19 45 66
 Monomando de bidé
 Single lever bidet mixer



Ref.: 65142 19 45 66
 Monomando de bidé con transmisión
 Single lever bidet mixer with diverter

Oslo | Baño y ducha | Bath & shower



Ref.: 65100 19 45 66
 Monomando de baño con kit
 Single lever bath mixer with kit



Ref.: 65110 19 45 66
 Monomando de ducha con kit
 Single lever shower mixer with kit



Ref.: 100197 45 00
 Mango de ducha C1 jet
 C1 jet handshower
Ref.: 100135 60 00
 Flexo H 1/2" - H 1/2" 1,70 m inoxidable
 F 1/2" - F 1/2" Stainless steel flexible hose 1.70 m
Ref.: 100153 45
 Soporte ducha cilíndrico
 Cylindrical shower holder

Oslo | Empotrados | Built-in single lever mixer



Ref.: 65115 19 45 66
 Monomando de ducha empotrado
 Built-in single lever shower mixer



Ref.: 65116 19 45 66
 Monomando de baño empotrado con inversor
 Built-in single lever bath mixer with diverter

Oslo | Cocina | Kitchen

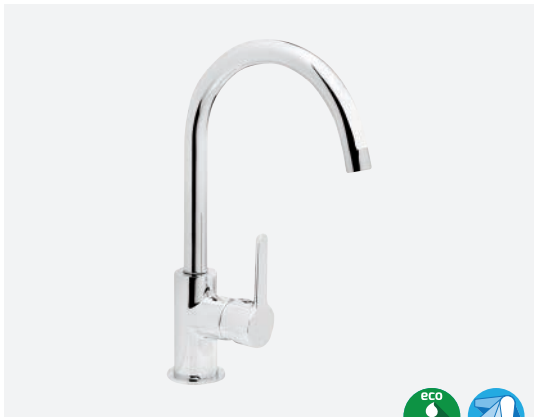

Ref.: 65203 19 45 66
 Monomando de fregadera apertura en frío
 Single lever sink mixer cold start



Ref.: 65192 19 45 66
 Monomando de fregadera mural 15 cm
 Wall single lever sink mixer 15 cm

Oslo | Columnas | Columns



Ref.: 1744 45
Set columna fija con kit
Fixed column set with kit



Ref.: CM65110 19
Columna monomando fija con kit
Single lever fixed column with kit



Ref.: CT67110 19
Columna termostática fija con kit
Thermostatic fixed column with kit



Nuevo sistema PALET BOX New PALET BOX system

Nueva colección de columnas fijas disponibles en versión set, manual y termostática. Y presentadas en el nuevo sistema de packaging Palet Box que facilita la visibilidad en el punto de venta.

New collection of fixed columns available in set, manual and thermostatic versions. And presented with the new packaging system Palet Box that facilitates its visibility at the sales point.



Ref. 1744 45

Ref. CM65110 19

Ref. CT67110 19

Klip

Eterna actualidad

Sus líneas rectas y depuradas, casi cuadradas, convierten esta colección Klip en una de nuestras series más solicitadas. Un diseño resistente al paso del tiempo y una sutil belleza que se unen perfectamente con el estilo de las cocinas y los baños más contemporáneos.

Timeless beauty

Its straight, refined and almost square lines, make this Klip collection one of our most wanted series. A timeless design with a subtle beauty, that combines perfectly with the most contemporary style kitchens and bathrooms.

Acabado cromado. Cartucho 40
Chromed finish. Cartridge 40





Klip | Monomando lavabo | Single lever wash-basin mixer



Ref.: 64130 16 45 66
 Monomando de lavabo
 Single lever wash-basin mixer
Cartucho 2 posiciones | 2 position cartridge



Ref.: 64134 16 45 66
 Monomando de lavabo medio alto
 Medium height single lever wash-basin mixer
Cartucho 2 posiciones | 2 position cartridge



Ref.: 64136 16 45 66
 Monomando de lavabo alto
 High single lever wash-basin mixer
Cartucho 2 posiciones | 2 position cartridge



Klip | Lavabo empotrado | Built-in single lever wash-basin mixer



Ref.: 64131 16 45 66
 Monomando de lavabo empotrado caño 16 cm
 Built-in wash-basin mixer 16 cm spout



Ref.: 64132 16 45 66
 Monomando de lavabo empotrado caño 22 cm
 Built-in wash-basin mixer 22 cm spout



Klip | Monomando bidé | Single lever bidet mixer



Ref.: 64140 16 45 66
Monomando de bidé
Single lever bidet mixer



Ref.: 64142 16 45 66
Monomando de bidé con transmisión
Single lever bidet mixer with diverter

Klip | Baño y ducha | Bath & shower



Ref.: 64100 16 45 66
Monomando de baño con kit
Single lever bath mixer with kit



Ref.: 64110 16 45 66
Monomando de ducha con kit
Single lever shower mixer with kit



Ref.: 100197 45 00
Mango de ducha C1 jet
C1 jet handshower
Ref.: 100135 60 00
Flexo H 1/2" - H 1/2" 1,70 m inoxidable
F 1/2" - F 1/2" Stainless steel flexible hose 1.70 m
Ref.: 100153 45
Soporte ducha cilíndrico
Cylindrical shower holder

Klip | Empotrados | Built-in single lever bath & shower mixers



Ref.: 64115 16 45 66
Monomando de ducha empotrado
Built-in single lever shower mixer



Ref.: 64116 16 45 66
Monomando de baño empotrado con inversor
Built-in single lever bath mixer with diverter

Klip | Termostática | Thermostatic mixers



Ref.: 67103 14 45 67
Termostática baño
Thermostatic bath mixer



Ref.: 67104 14 45 67
Termostática ducha
Thermostatic shower mixer



Klip | Style shower



Ref.: 64116 16 45 66

Monomando de baño empotrado con inversor
Built-in single lever bath mixer with diverter

Ref.: 1671 45

Brazo a techo redondo 15 cm
Round roof arm 15 cm

Ref.: R65112 18

Rociador redondo 22 cm
Round shower head 22 cm

Ref.: 1680 04

Toma ducha mural redonda
Round wall flexible connector

Ref.: 1748 45

Conjunto Tau, barra, flexo y ducha 5 jets
Tau set, bar, hose and 5 jets handshower



Ref.: 67103 14 45 67

Termostática baño
Thermostatic bath mixer

Ref.: 1745 45

Set columna extensible con ducha, soporte y flexo
Extensible column set with shower, holder and flexible hose



Klip | Cocina | Kitchen



Ref.: 64192 16 45 66
Monomando de fregadera mural
Wall single lever sink mixer



Ref.: 64201 16 45 66
Monomando de fregadera
Single lever sink mixer



Ref.: 64206 16 45 66
Monomando de fregadera ducha extraíble
Single lever sink mixer with pull-out spray





Klip 2

Discreta elegancia

Toda la personalidad de la serie Klip pero con un diseño todavía más sutil. Un grifo fino y esbelto cuya particularidad está en incorporar una maneta abierta que le dará un toque refinado y elegante a tu baño o tu cocina.

Discreet elegance

All of the personality of the Klip series but with an even more subtle design. A thin and slender tap with a special open-handle feature, giving a refined and elegant touch to your bathroom or kitchen.

Acabado cromado. Cartucho 40
Chromed finish. Cartridge 40

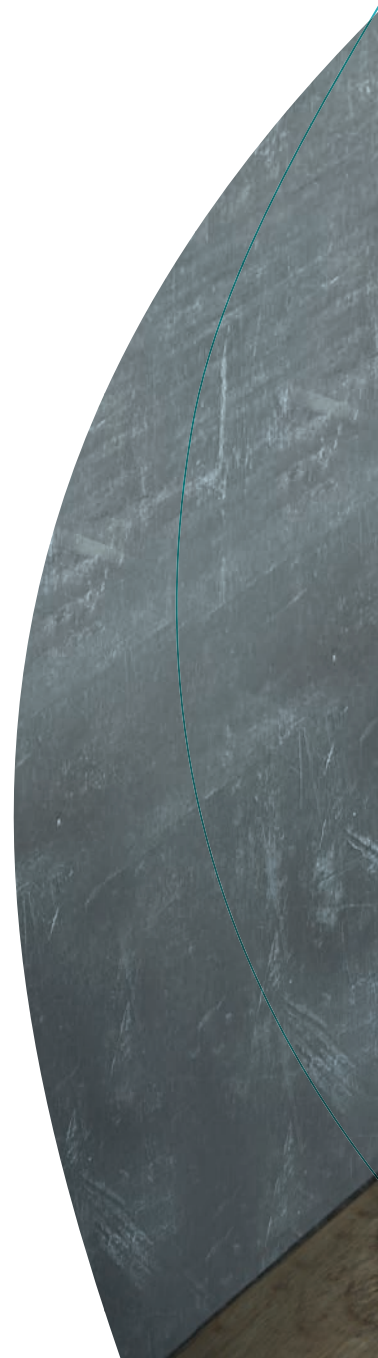



Klip 2 | Monomando lavabo | Single lever wash-basin mixers



Ref.: 64130 14 45 66
 Monomando de lavabo
 Single lever wash-basin mixer
Cartucho 2 posiciones | 2 position cartridge



Ref.: 64134 14 45 66
 Monomando de lavabo medio alto
 Medium height single lever wash-basin mixer
Cartucho 2 posiciones | 2 position cartridge



Ref.: 64136 14 45 66
 Monomando de lavabo alto
 High single lever wash-basin mixer
Cartucho 2 posiciones | 2 position cartridge



Klip 2 | Lavabo empotrado | Built-in single lever wash-basin mixer



Ref.: 64131 14 45 66
 Monomando de lavabo empotrado caño 16 cm
 Built-in wash-basin mixer 16 cm spout



Ref.: 64132 14 45 66
 Monomando de lavabo empotrado caño 22 cm
 Built-in wash-basin mixer 22 cm spout



Klip 2 | Monomando bidé | Single lever bidet mixer



Ref.: 64140 14 45 66
 Monomando de bidé
 Single lever bidet mixer



Ref.: 64142 14 45 66
 Monomando de bidé con transmisión
 Single lever bidet mixer with diverter

Klip 2 | Baño y ducha | Bath & shower



Ref.: 64100 14 45 66
 Monomando de baño con kit
 Single lever bath mixer with kit



Ref.: 64110 14 45 66
 Monomando de ducha con kit
 Single lever shower mixer with kit



Ref.: 100197 45 00
 Mango de ducha C1 jet
 C1 jet handshower
Ref.: 100135 60 00
 Flexo H 1/2" - H 1/2" 1,70 m inoxidable
 F 1/2" - F 1/2" Stainless steel flexible hose 1.70 m
Ref.: 100153 45
 Soporte ducha cilíndrico
 Cylindrical shower holder

Klip 2 | Empotrados | Built-in single lever bath & shower mixers

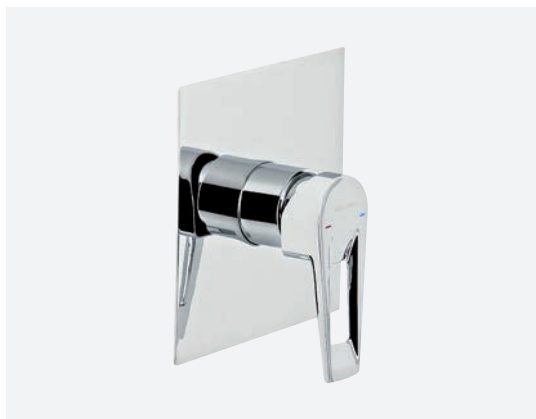

Ref.: 64115 14 45 66
Monomando de ducha empotrado
Built-in single lever shower mixer



Ref.: 64116 14 45 66
Monomando de baño empotrado con inversor
Built-in single lever bath mixer with diverter

Klip 2 | Cocina | Kitchen



Ref.: 64201 14 45 66
Monomando de fregadera
Single lever sink mixer



Ref.: 64206 14 45 66
Monomando de fregadera ducha extraíble
Single lever sink mixer with pull-out spray



Kelogic

Eficacia sostenible

La colección más ecológica de GENE BRE inspirada en los nuevos estilos de vida donde la responsabilidad medioambiental supone todo un compromiso. Su innovador sistema de apertura en frío te permitirá ahorrar agua y energía. Además, el caudal se regula con mayor facilidad proporcionando una experiencia más cómoda y agradable.

Sustainable efficiency

GENEBRE's most ecological collection is inspired by new lifestyles committed to environmental responsibility. Its innovative cold-opening system allows water and energy saving. Furthermore, water flow is regulated with greater ease, providing a more comfortable and pleasant experience.

Acabado cromado. Cartucho 40
Chromed finish. Cartridge 40

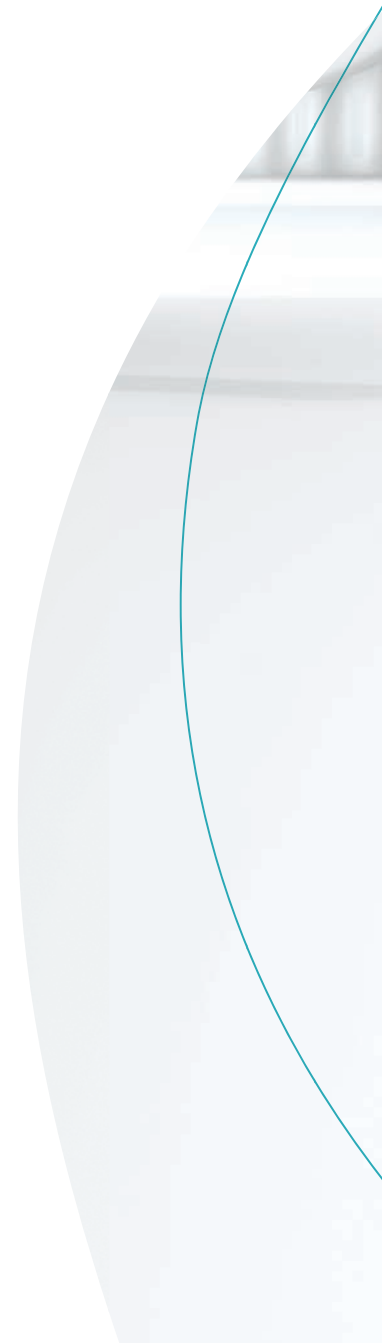



La serie más ecológica

The most environmental-friendly series

Apertura en frío Kelogic

La principal característica es el ahorro de energía. Al abrir el grifo en su posición central, saldrá solo agua fría, el agua caliente no saldrá mientras no giremos la maneta hacia la izquierda. Nuestro sistema Kelogic evita que su caldera o calentador se ponga en marcha innecesariamente.

Cold start, Kelogic

The main advantage of this series is energy savings. When you open the tap from its central position only cold water is used, and hot water only flows when the level is moved to the left. Energy is saved because our Kelogic system switches on the water heater only when necessary.

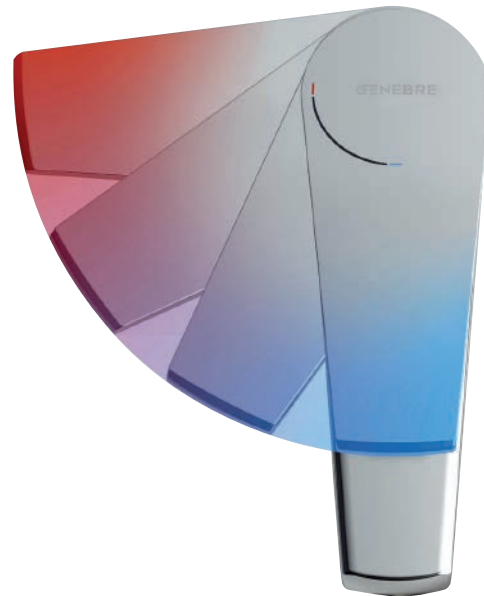

Ahorro de agua.
Water savings.



Ahorro energético.
Energy savings.

Inversor y racor ducha metálico.
Metallic shower diverter and adapter.



Sistema anti retorno con limitador de caudal dinámico.
Stop return valves with dynamic flow restrictor.

Flexible de alta resistencia, con sistema "anti-lock" y antibacteriano.
High-resistant, flexible, antibacterial hose with anti-lock system.

Cartucho Economizador 2 posiciones.
2-position cartridge saver.



Apertura en frío.
Cold start.

Atomizador economizador de agua.
Spray water economizer.

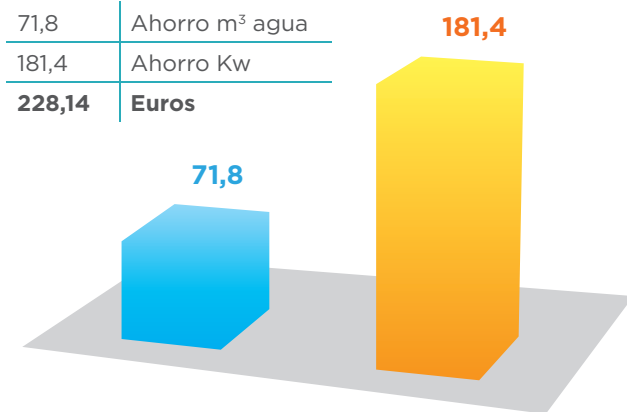

Ahorro anual

Vivienda para cuatro personas con calentador eléctrico.

Annual savings

Apartment for four people with electric heater.

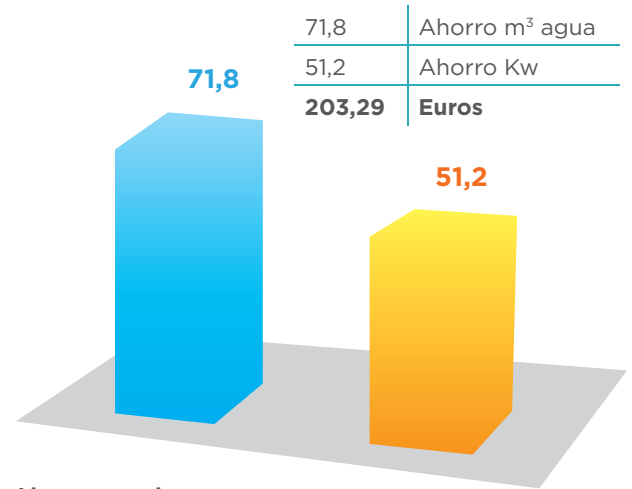

Ahorro anual

Vivienda para cuatro personas con calentador de gas.

Annual savings

Apartment for four people with gas heater.

Valores de consumo medio:

Realizando 4 aperturas en lavabo de 35 segundos de duración, consumo monomando lavabo 12 l / min. y 1 ducha por persona de 6 minutos de duración a 38°C, consumo monomando de ducha 9 l/min. 85% agua caliente y 15% agua fría, con un uso del 30% en agua caliente.

Average consumption values

Making 4 openings in basin of 35 seconds of duration, consumption single lever wash-basin mixer 12 l / min. and 1 shower per person of 6 minutes of duration at 38°C, consumption shower mixer 9 l / min. 85% hot water and 15% cold water, with a 30% use in hot water.

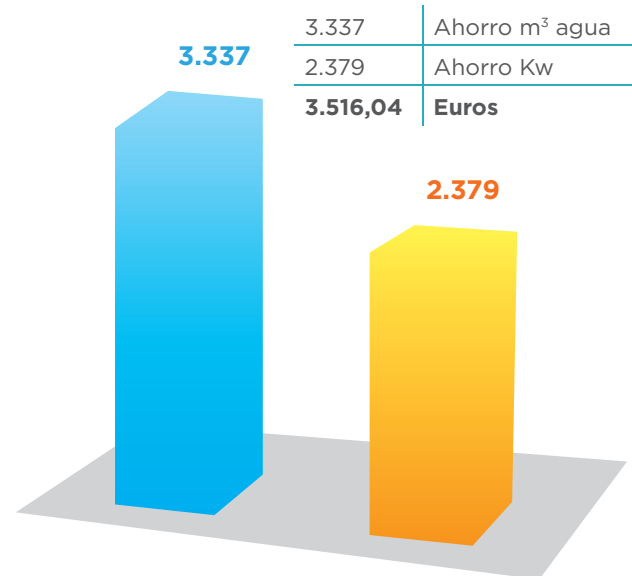

Ahorro anual

Hotel de 100 habitaciones dobles con caldera de gas.

Annual savings

Hotel with 100 double rooms with gas boiler.

Kelagic | Monomando lavabo | Single lever wash-basin mixers



Ref.: 64130 04 45 66

Monomando de lavabo apertura en frío
Single lever wash-basin mixer cold start

Aireador economizador Cartucho 2 posiciones |
Economizer aerator 2 position cartridge



Ref.: 64134 04 45 66

Monomando lavabo medio alto apertura en frío
Medium height single lever wash-basin mixer cold start

Aireador economizador Cartucho 2 posiciones |
Economizer aerator 2 position cartridge



Ref.: 64136 04 45 66

Monomando lavabo alto apertura en frío
High single lever wash-basin mixer cold start

Aireador economizador Cartucho 2 posiciones |
Economizer aerator 2 position cartridge



Kelagic | Monomando bidé | Single lever bidet mixer



Ref.: 64140 04 45 66

Monomando bidé apertura en frío
Single lever bidet mixer cold start

Cartucho 2 posiciones | 2 position cartridge



Ref.: 64142 16 45 66

Monomando de bidé con transmisión
Single lever bidet mixer with diverter

Kelagic | Baño y ducha | Bath & shower



Ref.: 64110 04 45 66
 Monomando de ducha con kit
 Single lever shower mixer with kit
Función ducha con antirretorno economizador |
 Economizer stop return shower function



Ref.: 64100 04 45 66
 Monomando de baño con kit
 Single lever bath mixer with kit
Función ducha con antirretorno economizador |
 Economizer stop return shower function



Ref.: 100197 45 00
 Mango de ducha C1 jet
 C1 jet handshower
Ref.: 100153 45
 Soporte ducha cilíndrico
 Cylindrical shower holder
Ref.: 100140 30
 Flexo H 1/2" - H 1/2" 1,70 m. PVC antirrotura
 F 1/2" - F 1/2" PVC flexible hose 1.70 m anti-
 breaking

Kelagic | Empotrado | Built-in single lever bath & shower mixers

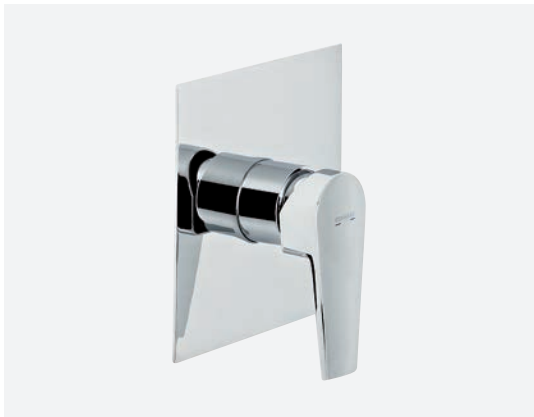

Ref.: 64115 16 45 66
 Monomando de ducha empotrado
 Built-in single lever shower mixer



Ref.: 64117 04 45 66
 Monomando empotrado con inversor cerámico 2
 vías
 Built-in single lever mixer with 2-way ceramic
 diverter



Ref.: 64118 04 45 66
 Monomando empotrado con inversor cerámico 3
 vías
 Built-in single handle mixer with 3-way ceramic
 diverter

Kelogic | Cocina | Kitchen

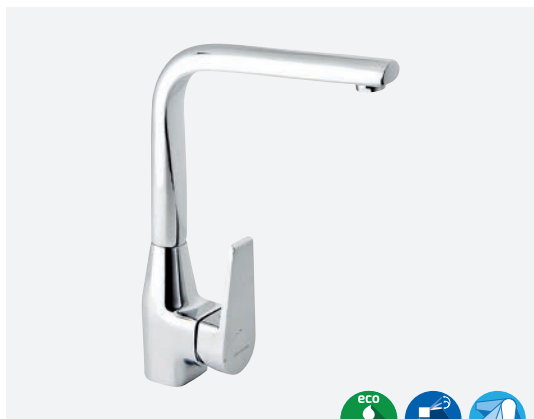

Ref.: 64201 04 45 66

Monomando de fregadera apertura frío

Single lever sink mixer cold start

Atomizador economizador Cartucho 2 posiciones

| Economizer aerator 2 position cartridge



GENEBRE

Tau

Identidad propia

Líneas cilíndricas y curvas esbeltas unidas para dar lugar a esta cautivadora serie Tau. Su estilizada silueta será la responsable de transformar tu cocina y tu baño en un espacio con personalidad propia. Una amplia gama de versiones capaz de adaptarse a cualquier ambiente.

Own identity

Cylindrical lines and sleek curves come together to create this captivating Tau series. Its slender silhouette will transform your kitchen and bathroom into a space with its very own personality. It provides a wide range of versions, which can be adapted to any setting.

Acabado cromado. Cartucho 40
Chromed finish. Cartridge 40





Tau | Monomando lavabo | Single lever wash-basin mixers



Ref.: 65135 18 45 66
Monomando de lavabo
Single lever wash-basin tap



Ref.: 65134 18 45 66
Monomando de lavabo medio alto
Medium height single lever wash-basin mixer



Ref.: 65136 18 45 66
Monomando de lavabo alto
High single lever wash-basin mixer

Tau | Lavabo empotrado | Built-in single lever wash-basin mixers



Ref.: 65138 18 45 66
Monomando de lavabo apertura en frío
Single lever wash-basin tap cold start



Ref.: 65131 18 45 66
Monomando de lavabo empotrado caño 16 cm
Built-in wash-basin mixer 16 cm spout



Ref.: 65132 18 45 66
Monomando de lavabo empotrado caño 22 cm
Built-in wash-basin mixer 22 cm spout

Tau | Monomando bidé | Single lever bidet mixers



Ref.: 65145 18 45 66
 Monomando de bidé
 Single lever bidet mixer



Ref.: 65142 18 45 66
 Monomando de bidé con transmisión
 Single lever bidet mixer with diverter

Tau | Baño y ducha | Bath & shower



Ref.: 65100 18 45 66
 Monomando de baño con kit
 Single lever bath mixer with kit



Ref.: 65110 18 45 66
 Monomando de ducha con kit
 Single lever shower mixer with kit



Ref.: 100197 45 00
 Mango de ducha C1 jet
 C1 jet handshower
Ref.: 100135 60 00
 Flexo H 1/2" - H 1/2" 1,70 m inoxidable
 F 1/2" - F 1/2" Stainless steel flexible hose 1.70 m
Ref.: 100153 45
 Soporte ducha cilíndrico
 Cylindrical shower holder

Tau | Empotrados | Built-in single lever bath & shower mixers



Ref.: 65115 18 45 66
Monomando de ducha empotrado
Built-in single lever shower mixer



Ref.: 65116 18 45 66
Monomando de baño empotrado con inversor
Built-in single lever mixer bath with diverter

Tau | Empotrados | Built-in single lever bath & shower mixers and Diverter



Ref.: 65117 18 45 66
Monomando empotrado con inversor cerámico 2 vías
Built-in single lever mixer with 2-way ceramic diverter



Ref.: 65118 18 45 66
Monomando empotrado con inversor cerámico 3 vías
Built-in single lever mixer with 3-way ceramic diverter



Ref.: 65114 30 45 66
Inversor cerámico 3 vías empotrado con placa cuadrada
Built-in 3-way ceramic diverter with square plate

Tau | Termostática | Thermostatic mixers



Ref.: 67102 14 45 67
 Termostática baño
 Thermostatic bath mixer



Ref.: 67112 14 45 67
 Termostática ducha
 Thermostatic shower mixer



Tau | Termostática empotrada | Built-in thermostatic mixers

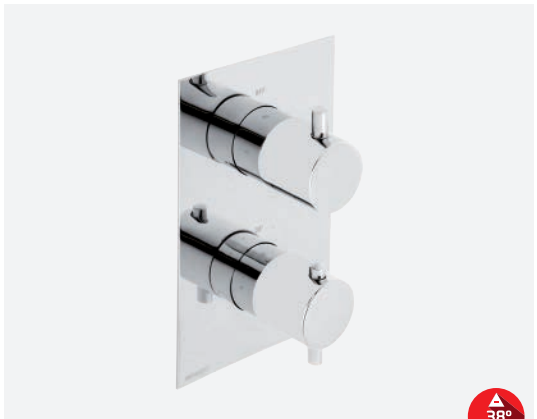

Ref.: 64114 14 45 67
 Termostática empotrada 2 vías
 Built-in 2-way thermostatic mixer

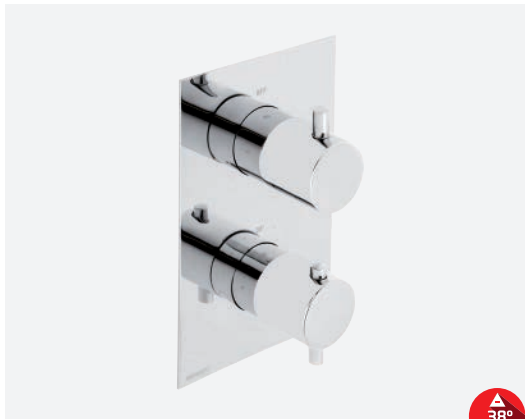

Ref.: 64111 14 45 67
 Termostática empotrada 3 vías
 Built-in 3-way thermostatic



Tau | Columna | Columns



Ref.: CM65110 18
Columna monomando extensible con kit
Single lever extensible column with kit



Ref.: CT67110 18
Columna termostática extensible con kit
Thermostatic extensible column with kit



Ref.: 1745 45
Set columna extensible con ducha, soporte y flexo
Extensible column set with shower, holder and
flexible hose





Tau | Cocina | Kitchen



Ref.: 65211 18 45 66
Monomando de fregadera con muelle
Single lever sink mixer with spring



Ref.: 65212 18 45 66
Monomando de fregadera con muelle y caño
Single lever sink mixer with spring and spout



Tau | Cocina | Kitchen



Ref.: 65214 18 45 66
Monomando de fregadera cartucho 40
Single lever sink mixer 40 cartridge



Ref.: 65204 18 45 66
Monomando de fregadera cartucho 40
Single lever sink mixer 40 cartridge



Tau | Cocina | Kitchen



Ref.: 65203 18 45 66
Monomando de fregadera cartucho 40
Single lever sink mixer 40 cartridge



Ref.: 65404 18 45 66
Monomando de fregadera cartucho 35 apertura
en frío
Single lever sink mixer 35 cartridge cold start



Ref.: FRT65402
Monomando de fregadera cartucho 35 apertura
en frío
Single lever sink mixer 35 cartridge cold start





Tau | Cocina | Kitchen



Ref.: 65219 18 45 66
 Monomando de fregadera cartucho 25 apertura en frío
 Single lever sink mixer 25 cartridge cold start



Ref.: 65403 18 45 66
 Monomando de fregadera cartucho 25 apertura en frío
 Single lever sink mixer 25 cartridge cold start



Tau | Cocina | Kitchen

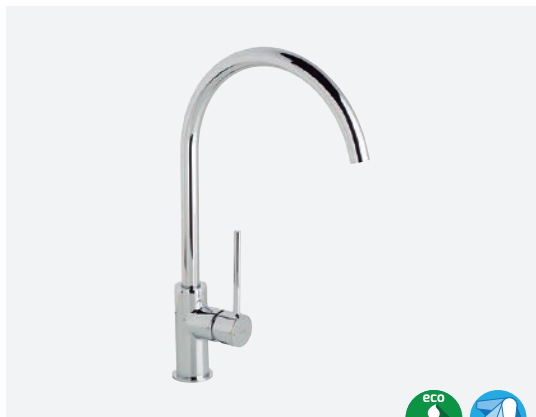

Ref.: FRT65401
 Monomando de fregadera cartucho 25 apertura en frío
 Single lever sink mixer 25 cartridge cold start



Ref.: 65900 18 45 66
 Monomando de fregadera abatible cartucho 35 apertura en frío
 Single lever folding sink mixer 35 cartridge cold start



Ref.: 65192 18 45 66
 Monomando de fregadera mural 15 cm
 Wall single lever sink mixer 15 cm

Tu propio manantial en casa Your own spring home-water

El nuevo sistema de filtración GENE BRE purifica el agua conservando todos los minerales y propiedades beneficiosas para la salud, y al reducir el consumo de agua embotellada de plástico, ahorramos y contribuimos también al respeto por el medio ambiente.

The new GENE BRE filtration system purifies water conserving all the minerals and properties that are beneficial to your health; and reduces the use of plastic bottled water, contributing to saving and respect for the environment.

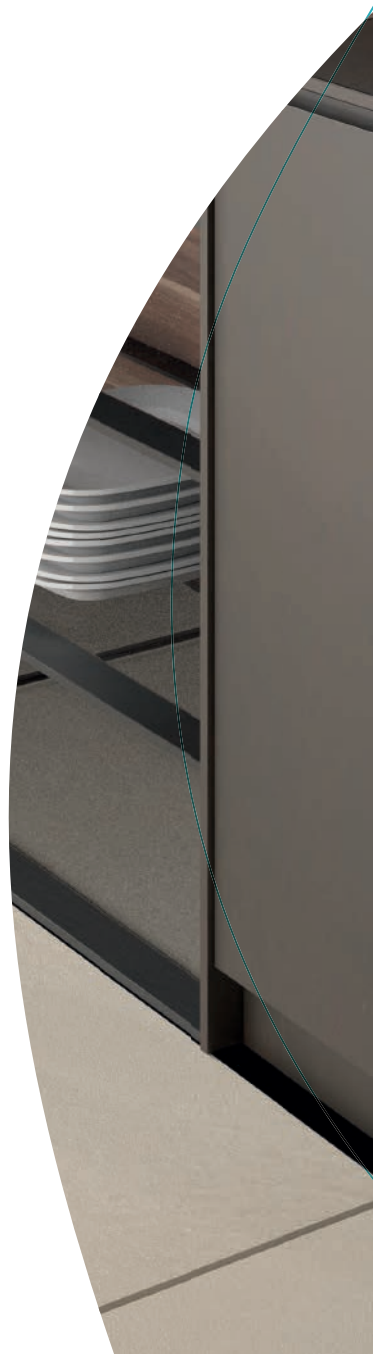
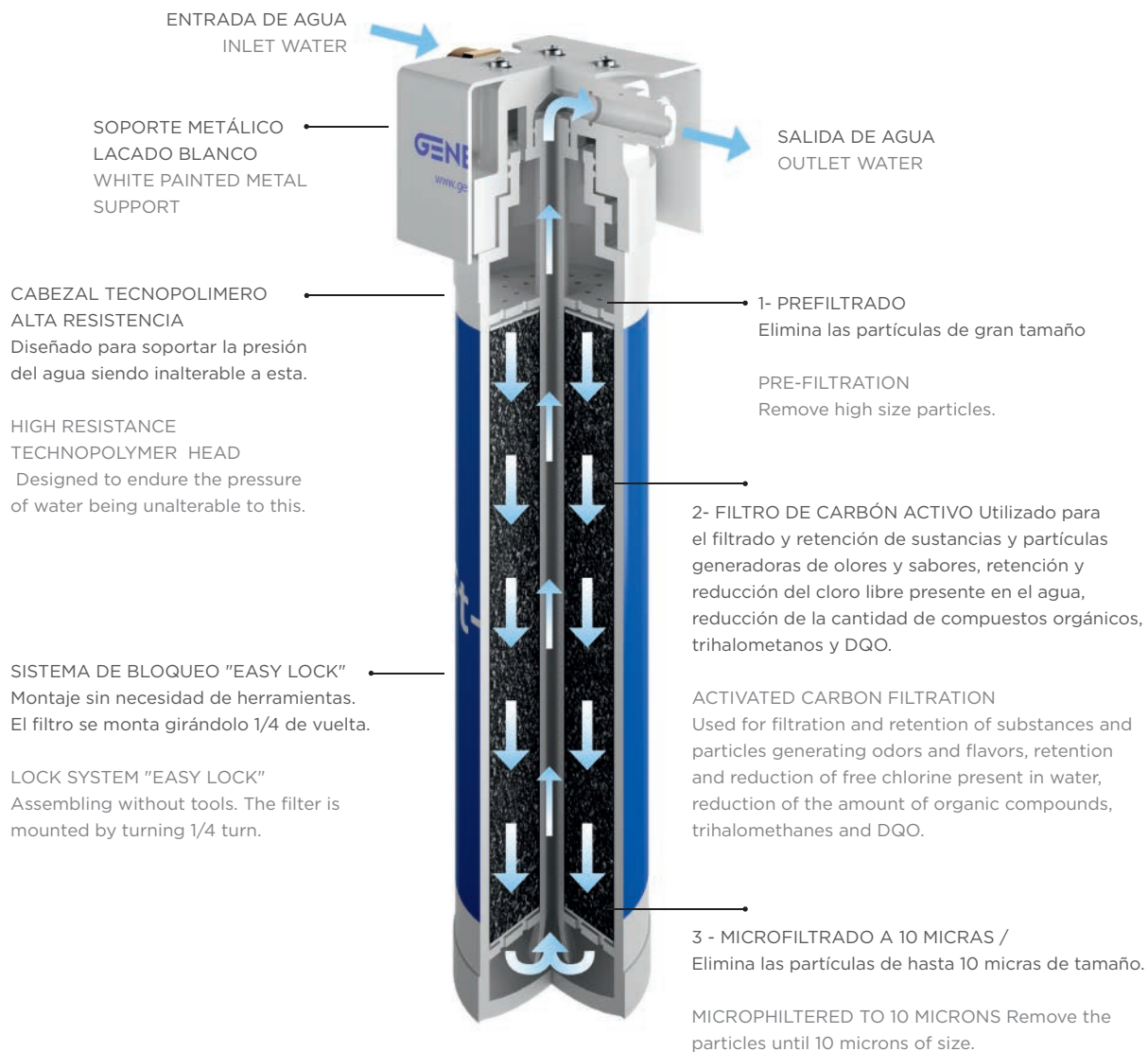





Tau | Cocina | Kitchen



Ref.: 65702 18 45 66
Monomando de fregadera 3 vías
Single lever 3-way sink mixer



Ref.: 65700 18 45 66
Grifo de 1 vía
One way tap

Tau | Cocina | Kitchen



Ref.: FT00
Kit declorador
Filtro declorador



Ref.: FT92
Filtro declorador
Declorator filter



Tau | Cocina | Kitchen



Ref.: 65206 18 45 66
Monomando de fregadera caño extraíble
Single lever sink mixer with pull-out spout



Ref.: 65205 18 45 66
Monomando de fregadera ducha extraíble
Single lever sink mixer with pull-out spray



Tau | Cocina | Kitchen

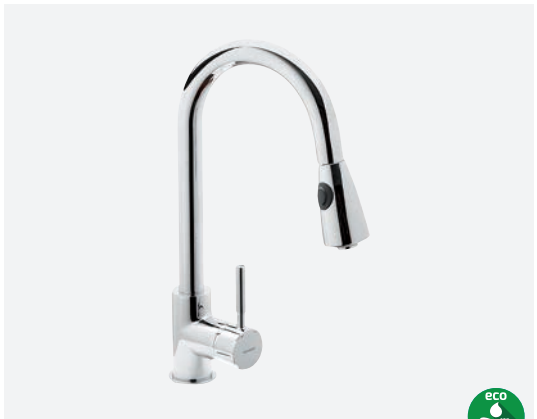

Ref.: FRV61205
Monomando de fregadera ducha extraíble
Single lever sink mixer with pull-out spray

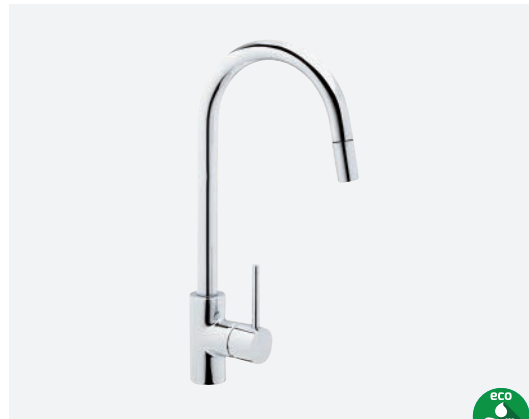

Ref.: FRV61206
Monomando de fregadera caño extraíble
Single-lever sink mixer with pull-out spout



Tau 2

Formas en contraste

Una maneta completamente recta en perfecta armonía con el caño tubular de la colección Tau. Una mezcla de formas con estilo propio basado en la disparidad de siluetas que otorga a esta colección un aspecto muy particular, depurado y moderno.

Contrasting shapes

The completely straight handle in perfect harmony with the tubular spout of the Tau collection. A mixture of shapes with their own style based on diverse silhouettes, provides this collection with a very special, refined and modern appearance.

Acabado cromado. Cartucho 40
Chromed finish. Cartridge 40





Tau 2 | Monomando lavabo | Single lever wash-basin mixers



Ref.: 65135 29 45 66
Monomando de lavabo
Single lever wash-basin mixer



Ref.: 65134 29 45 66
Monomando de lavabo medio alto
Medium height single lever wash-basin mixer



Ref.: 65136 29 45 66
Monomando de lavabo alto
High single lever wash-basin mixer

Tau 2 | Lavabo empotrado | Built-in single lever wash-basin mixers



Ref.: 65131 29 45 66
Monomando de lavabo empotrado caño 16 cm
Built-in wash-basin mixer 16 cm spout



Ref.: 65132 29 45 66
Monomando de lavabo empotrado caño 22 cm
Built-in wash-basin mixer 22 cm spout



Tau 2 | Monomando bidé | Single lever bidet mixers



Ref.: 65145 29 45 66
 Monomando de bidé
 Single lever bidet mixer



Ref.: 65142 29 45 66
 Monomando de bidé con transmisión
 Single lever bidet mixer with diverter

Tau 2 | Baño y ducha | Bath & shower



Ref.: 65100 29 45 66
 Monomando de baño con kit
 Single lever bath mixer with kit



Ref.: 65110 29 45 66
 Monomando de ducha con kit
 Single lever shower mixer with kit



Ref.: 100197 45 00
 Mango de ducha C1 jet
 C1 jet handshower
Ref.: 100135 60 00
 Flexo H 1/2" - H 1/2" 1,70 m inoxidable
 F 1/2" - F 1/2" Stainless steel flexible hose 1.70 m
Ref.: 100153 45
 Soporte ducha cilíndrico
 Cylindrical shower holder

Tau 2 | Empotrados |
Built-in single lever bath & shower mixers



Ref.: 65115 29 45 66
Monomando de ducha empotrado
Built-in single lever shower mixer



Ref.: 65116 29 45 66
Monomando de baño empotrado con inversor
Built-in single lever bath mixer with diverter

Tau 2 | Columna | Column



Ref.: CM65110 29
Columna monomando extensible con kit
Single lever extensible column with kit



Kenjo

El placer del agua

El minimalismo de su silueta recta y el esmero en cada uno de los detalles son las señas de identidad de esta serie Kenjo. Su diseño transmite un estilo espectacular en su sofisticación y serenidad. La salida del agua puede ser libre o tipo cascada, dejándola fluir en una experiencia de auténtico placer.

The pleasure of water

The minimalist design of its straight silhouette and care taken with every detail, are the hallmarks of this Kenjo series. Its design transmits spectacular style filled with serenity and sophistication. The mouth can be free or cascading, making the water flow an authentically pleasurable experience.

Acabado cromado. Cartucho 35
Chromed finish. Cartridge 35

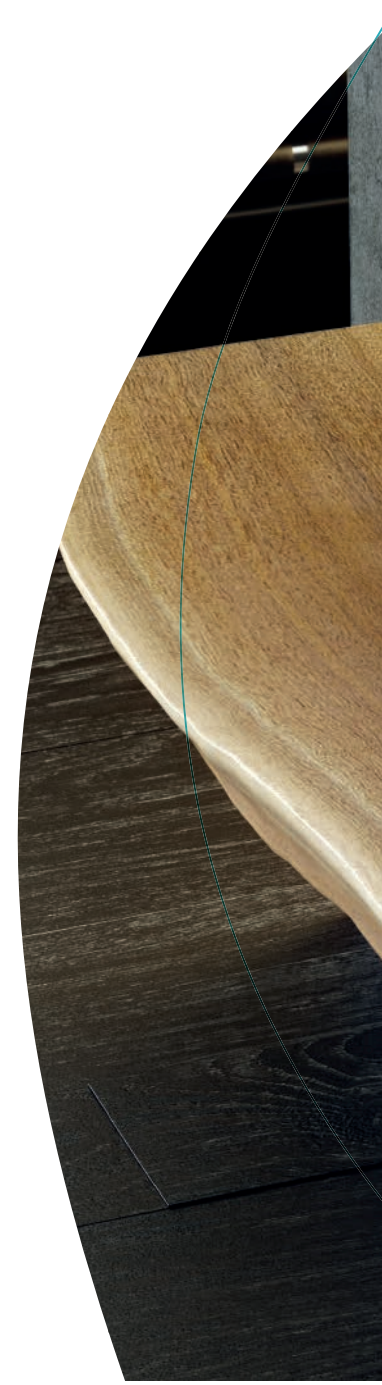



Kenjo | Monomando lavabo | Single lever wash-basin mixers



Ref.: 63130 26 45 66
Monomando de lavabo
Single lever wash-basin mixer



Ref.: 63134 26 45 66
Monomando de lavabo medio alto
Medium height single lever wash-basin mixer



Ref.: 63136 26 45 66
Monomando de lavabo alto
High single lever wash-basin mixer

Kenjo | Lavabo cascada | Waterfall single lever wash-basin mixers



Ref.: 63137 26 45 66
Monomando de lavabo cascada
Waterfall single lever wash-basin mixer



Ref.: 63138 26 45 66
Monomando de lavabo cascada alto
High waterfall single lever wash-basin mixer





Kenjo | Lavabo empotrado | Built-in single lever wash-basin mixers



Ref.: 63131 26 45 66
Monomando de lavabo empotrado caño 16 cm
Built-in wash-basin mixer 16 cm spout



Ref.: 63132 26 45 66
Monomando de lavabo empotrado caño 22 cm
Built-in wash-basin mixer 22 cm spout



Kenjo | Monomando bidé | Single lever bidet mixer



Ref.: 63140 26 45 66
Monomando de bidé
Single lever bidet mixer



Ref.: 63142 26 45 66
Monomando de bidé con transmisión
Single lever bidet mixer with diverter

Kenjo | Baño y ducha | Bath & shower



Ref.: 63100 26 45 67
 Monomando de baño sin kit
 Single lever bath mixer without kit



Ref.: 63110 26 45 67
 Monomando de ducha sin kit
 Single lever shower mixer without kit



Ref.: DXK3 45
 Mango de ducha K3 jets
 K3 jets handshower
Ref.: 100135 60 00
 Flexo H 1/2" - H 1/2" 1,70 m inoxidable
 F 1/2" - F 1/2" Stainless steel flexible hose 1.70 m
Ref.: 100149 45
 Soporte ducha Kenjo
 Kenjo shower holder

Kenjo | Empotrados | Built-in single lever bath and shower mixers



Ref.: 63115 26 45 66
 Monomando de ducha empotrado
 Built-in single lever shower mixer



Ref.: 63116 26 45 66
 Monomando de baño empotrado con inversor
 Built-in single lever bath with mixer with diverter

Kenjo | Termostática | Thermostatic mixers



Ref.: 67100 26 45 67
Termostática de baño sin kit
Thermostatic bath mixer without kit



Ref.: 67110 26 45 67
Termostática ducha sin kit
Thermostatic shower mixer without kit



Kenjo | Cocina | Kitchen



Ref.: FRK63401
Monomando de fregadera cartucho 25
Single lever sink mixer 25 cartridge



Ref.: FRK63400
Monomando de fregadera cartucho 25
Single lever sink mixer 25 cartridge





Kenjo



Ref.: CM63110 26
Columna monomando extensible con kit
Single lever extensible column with kit



Ref.: CT67110 26
Columna termostática extensible con kit
Thermostatic extensible column with kit



Ref.: 1746 45
Set columna extensible con ducha, soporte y flexo
Extensible column set with shower, holder and
flexible hose



Inox

Pasión por la cocina

Especialmente diseñada para el universo culinario, la colección Inox resulta indispensable para cualquier cocina contemporánea por su diseño elegante, estilizado y funcional. Fabricada en acero inoxidable, sus estilizadas formas darán un aspecto siempre limpio y moderno a tu cocina.

Passion for cooking

Especially designed for the culinary universe, the Inox collection is indispensable for any contemporary kitchen, due to its elegant, slender and functional design. Made from stainless steel, its sleek shape will give your kitchen that always clean and modern appearance.

Acero Inoxidable. Cartucho 35
Stainless Steel. Cartridge 35





Inox | Cocina | Kitchen



Ref.: 65219 40 60 66
 Monomando de fregadera cartucho 25
 Single lever sink mixer 25 cartridge



Ref.: 65215 40 60 66
 Monomando de fregadera cartucho 25
 Single lever sink mixer 25 cartridge

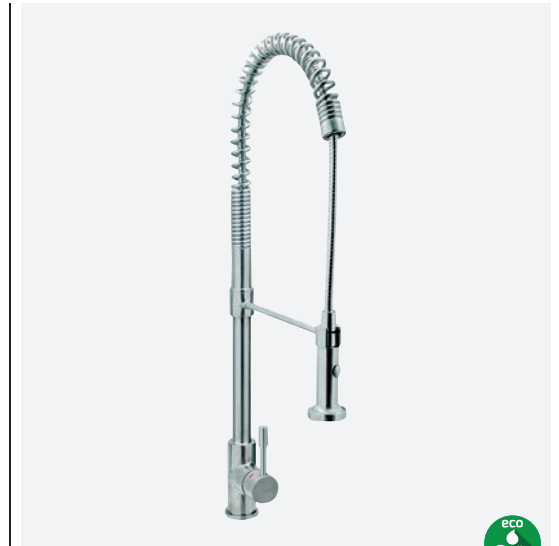

Ref.: 65211 18 60 66
 Monomando de fregadera inox con muelle
 Stainless steel single lever sink mixer with spring



Inox | Cocina | Kitchen



Ref.: 65207 18 60 66
 Monomando de fregadera inox con muelle y
 ducha extraíble
 Stainless steel single lever sink mixer with spring
 and pull-out sprayer

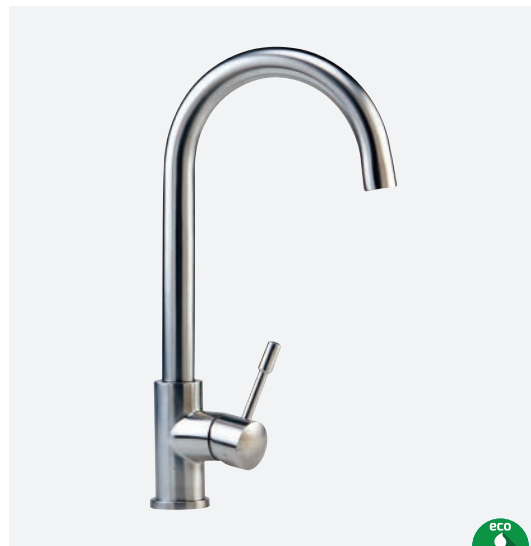

Ref.: 65203 18 60 66
 Monomando de fregadera inox caño cisne
 Stainless steel single lever sink mixer with swan
 spout



Ref.: 65208 18 60 66
 Monomando de fregadera inox con cartucho
 progresivo
 Stainless steel sink mixer with progressive
 cartridge





K8

Simplemente diseño

A veces, lo más sencillo puede ser inolvidable. Como esta colección de formas discretas y sutiles, combinadas con delicadas líneas curvas y rectas que le confieren una personalidad única y la convierten en la elección ideal para el baño o la cocina.

Simply design

Sometimes the simplest things can be unforgettable. Like this collection of discreet, subtle forms, combined with delicate curved and straight lines which give it a unique personality and make it the ideal choice for the bathroom and the kitchen.

Acabado cromado. Cartucho 40
Chromed finish. Cartridge 40

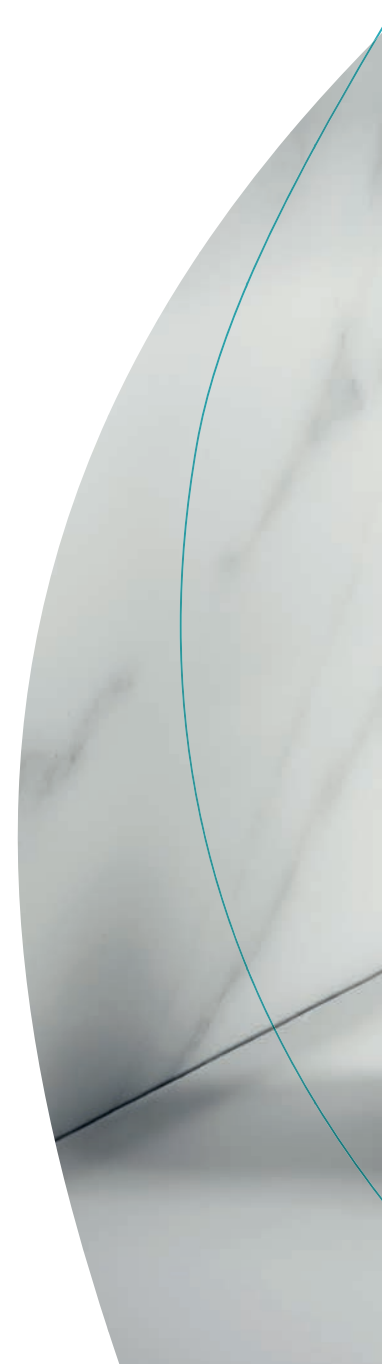



K8 | Monomando lavabo | Single lever wash-basin mixers



Ref.: 60134 28 45 66
Monomando de lavabo medio alto
Medium height single lever wash-basin mixer



Ref.: 61130 28 45 66
Monomando de lavabo Plus
Single lever Plus wash-basin mixer



Ref.: 60130 28 45 66
Monomando de lavabo
Single lever wash-basin mixer

K8 | Monomando lavabo | Single lever wash-basin mixers



Ref.: 60188 28 45 66
Monomando de lavabo centerset 4"
Single lever wash-basin mixer 4" centerset

K8 | Monomando bidé | Single lever bidet mixers



Ref.: 60140 28 45 66
Monomando de bidé
Single lever bidet mixer



Ref.: 61142 28 45 66
Monomando de bidé con transmisión
Single lever bidet mixer with diverter





K8 | Baño y ducha | Bath & shower



Ref.: 60100 28 45 66
Monomando de baño con kit
Single lever bath mixer with kit



Ref.: 60110 28 45 66
Monomando de ducha con kit
Single lever shower mixer with kit



Ref.: 100175 45 00
Mango de ducha E1 jet
E1 jet handshower
Ref.: 100135 60 00
Flexo H 1/2" - H 1/2" 1,70 m inoxidable
F 1/2" - F 1/2" Stainless steel flexible hose 1.70 m
Ref.: 100152 45 00
Soporte ducha Combi
Combi shower holder

K8 | Empotrados | Built-in single lever bath & shower mixers



Ref.: 61115 28 45 66
Monomando de ducha empotrado
Built-in single lever shower mixer



Ref.: 61116 28 45 66
Monomando de baño empotrado con inversor
Built-in single lever bath mixer with diverter



K8 | Cocina | Kitchen



Ref.: 61201 28 45 66
 Monomando de fregadera caño fundido
 Single lever sink mixer casted spout



Ref.: 61203 28 45 66
 Monomando de fregadera caño conformado
 Single-lever sink mixer tube spout



Ref.: 61204 28 45 66
 Monomando de fregadera caño conformado
 Single-lever sink mixer tube spout

K8 | Cocina | Kitchen



Ref.: 61210 28 45 66
 Monomando de fregadera caño fundido
 Single lever sink mixer casted spout



Ref.: 61206 28 45 66
 Monomando de fregadera ducha extraíble
 Single-lever sink mixer with pull-out spray



Ref.: 61205 28 45 66
 Monomando de fregadera ducha extraíble
 Single lever sink mixer with pull-out spray

K8 | Cocina | Kitchen



Ref.: 61192 28 45 66
Monomando de fregadera mural 15 cm
Wall single-lever sink mixer 15 cm



Ref.: 61190 28 45 66
Monomando de fregadera mural 15 cm caño corto
Wall single lever sink mixer 15 cm short spout



Ref.: 61195 28 45 66
Monomando de fregadera mural 11 cm
Wall single lever sink mixer 11 cm

K8 | Cocina | Kitchen



Ref.: 61196 28 45 66
Monomando de fregadera caño inferior elevado
Wall single lever sink mixer low spout



Ref.: 61200 28 45 66
Monomando de fregadera
Single lever sink mixer



Ref.: 61900 28 45 66
Monomando de fregadera abatible
Single lever folding sink mixer



Ge2

La belleza de la sencillez

La personalidad inconfundible de la colección Ge2 se muestra a través de sus poderosas formas naturales y sus líneas curvas, ergonómicas y ligeramente inclinadas. Un diseño dinámico y sencillo, que otorgará a tu baño y a tu cocina un aspecto sugerente y cautivador.

The beauty of simplicity

The distinctive personality of the Ge2 collection can be seen in its strong natural forms and its curved, ergonomic and delicately sloping lines. Its dynamic and simple design, provides your kitchen and bathroom with a suggestive and captivating appearance.

Acabado cromado. Cartucho 40
Chromed finish. Cartridge 40

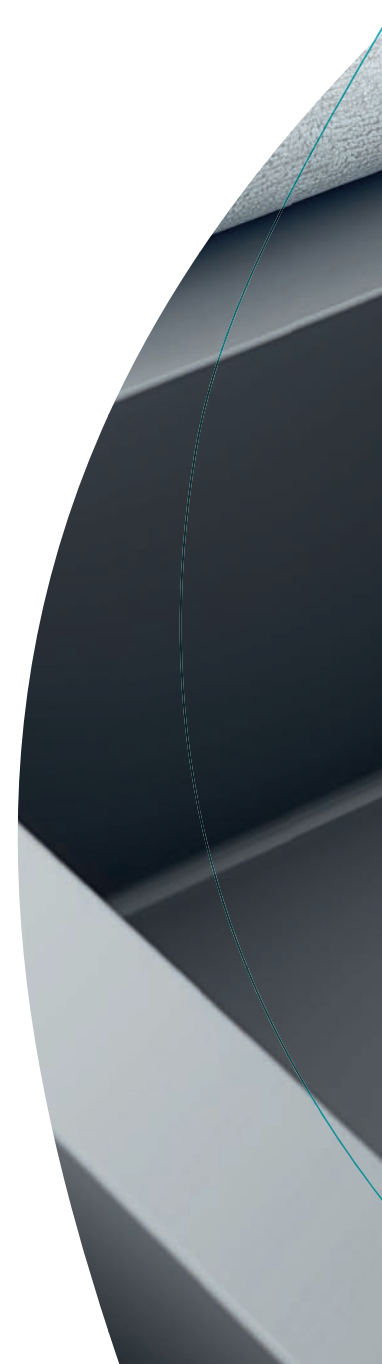



Ge2 | Monomando lavabo | Single lever wash-basin mixers



Ref.: 61130 22 45 66
Monomando de lavabo Plus
Single lever Plus wash-basin mixer



Ref.: 60130 22 45 66
Monomando de lavabo
Single lever wash-basin mixer



Ref.: 60188 22 45 66
Monomando de lavabo centerset 4"
Single lever wash-basin mixer 4" centerset

Ge2 | Monomando bidé | Single lever bidet mixers



Ref.: 60140 22 45 66
Monomando de bidé
Single lever bidet mixer



Ref.: 61142 22 45 66
Monomando de bidé con transmisión
Single lever bidet mixer with diverter

Ge2 | Baño y ducha | Bath & shower



Ref.: 60100 22 45 66
 Monomando de baño con kit
 Single lever bath mixer with kit



Ref.: 60110 22 45 66
 Monomando de ducha con kit
 Single lever shower mixer with kit



Ref.: 100175 45 00
 Mango de ducha E1 jet
 E1 jet handshower
Ref.: 100135 60 00
 Flexo H 1/2" - H 1/2" 1,70 m inoxidable
 F 1/2" - F 1/2" Stainless steel flexible hose 1.70 m
Ref.: 100152 45 00
 Soporte ducha Combi
 Combi shower holder

Ge2 | Empotrados | Built-in single lever bath & shower mixers



Ref.: 61116 22 45 66
 Monomando de baño empotrado con inversor
 Built-in single lever bath mixer with diverter



Ref.: 61115 22 45 66
 Monomando de ducha empotrado
 Built-in single lever shower mixer

Ge2 | Style shower

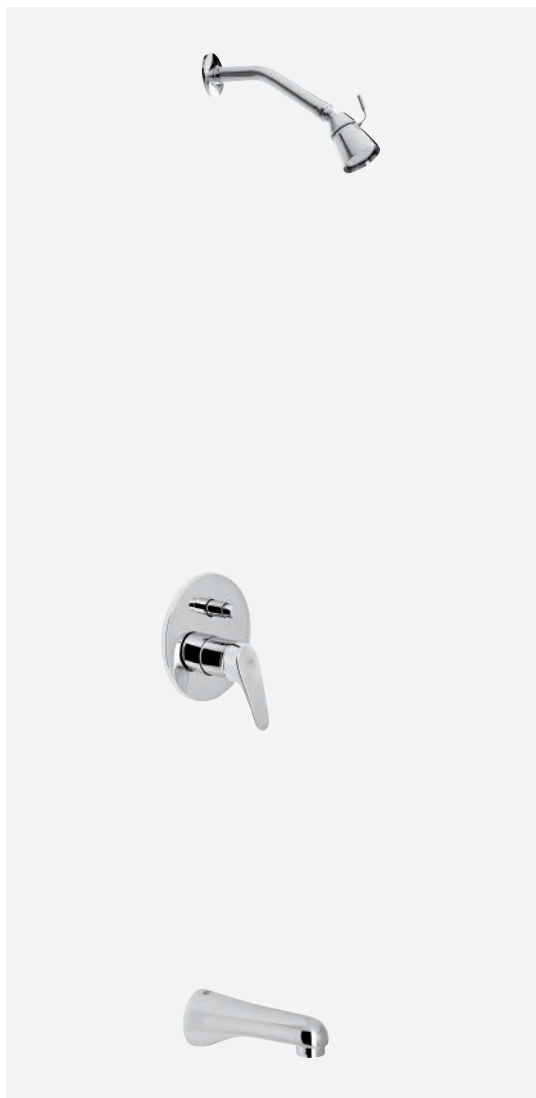

Ref.: 61116 22 45 66

Monomando de baño empotrado con inversor
Built-in single lever bath mixer with diverter

Ref.: 1698 45

Rociador ducha con brazo
Wall shower arm and spray

Ref.: 1667 45

Caño mural baño fundido
Casted wall bath spout



Ref.: 61116 22 45 66

Monomando de baño empotrado con inversor
Built-in single lever bath mixer with diverter

Ref.: B65113 18

Brazo pared redondo 35 cm
Round wall arm 35 cm

Ref.: R65112 18

Rociador redondo 22 cm
Round shower head 22 cm

Ref.: 1638 45

Barra ducha redonda
Round shower bar

Ref.: 1680 04

Toma ducha mural redonda
Round wall flexible connector

Ref.: DXE2 45

Mango de ducha E2 jets
E2 jets handshower

Ref.: 100135 60 00

Flexo H 1/2" - H 1/2" 1,70 m inoxidable
F 1/2" - F 1/2" Stainless steel flexible hose 1.70 m

Ge2 | Teleducha bidé | Bidet shower



Ref.: 60001 22 45 67
Grifo bide mural 1 agua
1 water wall bidet



Ref.: 100141 45
Flexo H 1/2" - H 1/2" 1,20 m inoxidable
F 1/2" - F 1/2" Stainless steel flexible hose 1.20 m
Ref.: 100696 45
Kit ducha sanitaria
Sanitary shower kit



Ref.: 1024 04
Grifo doble combinable a 1/2"- 3/4" y Aireador
Double outlet tap 1/2" - 3/4" and aerator

Ge2 | Grifos 1 agua | One-water taps



Ref.: 1002 04
Grifo lavabo 1 agua cartucho 25
One-water wash-basin tap 25 cartridge



Ref.: 1003 04
Grifo lavabo mural 1 agua cartucho 25
One-water wall wash-basin tap 25 cartridge



Ref.: 1009 04
Grifo fregadera 1 agua cartucho 25
One-water sink tap 25 cartridge

Ge2 | Fregaderas 1 agua | One-water sink taps



Ref.: 1008 04
Grifo mural con tubo 24 cm 1 agua cartucho 25
One-water wall sink tap spout 24 cm 25 cartridge



Ref.: 1005 04
Grifo mural con tubo alto 1 agua cartucho 25
One-water wall sink tap high spout 25 cartridge



Ref.: 60198 05 45 66
Monomando mesada 8"
8" widespread single lever sink mixer

Ge2 | Fregaderas 1 agua | One-water sink taps



Ref.: 60199 05 45 66
Monomando mesada 6"
6" widespread single lever sink mixer



Ref.: 60194 05 45 66
Monomando de fregadera mural 8"
Wall single lever 8" sink mixer

Ge2 | Grifos 1 agua | One-water taps



Ref.: 1023 04
Grifo doble combinable 1/2"-3/4" y 1/2"
Double outlet tap 1/2"-3/4" and 1/2"



Ref.: 1006 04
Grifo lavabo mural 1 agua cartucho 25
One-water wall wash-basin tap 25 cartridge



Ref.: 1007 04
Grifo lavabo 1 agua cartucho 25
One-water wash-basin tap 25 cartridge

New Regent Classic

Glamour vintage

Sus acabados de calidad en cromo o bronce y sus formas inspiradas en el pasado dan forma a esta colección de estilo clásico y elegante. La readaptación del aspecto más tradicional de su diseño, refinado y cautivador, te permitirá disfrutar del encanto vintage en tu baño y tu cocina.

Vintage glamour

Its quality finishes in chrome and bronze, and shapes inspired by the past, give form to this classical and elegant style collection. The re-adaptation of the most traditional aspects of its refined and captivating design, allows you to enjoy vintage charm in your kitchen or bathroom.

Montura 1/4 vuelta cierre cerámico
Ceramic headwork quarter turn

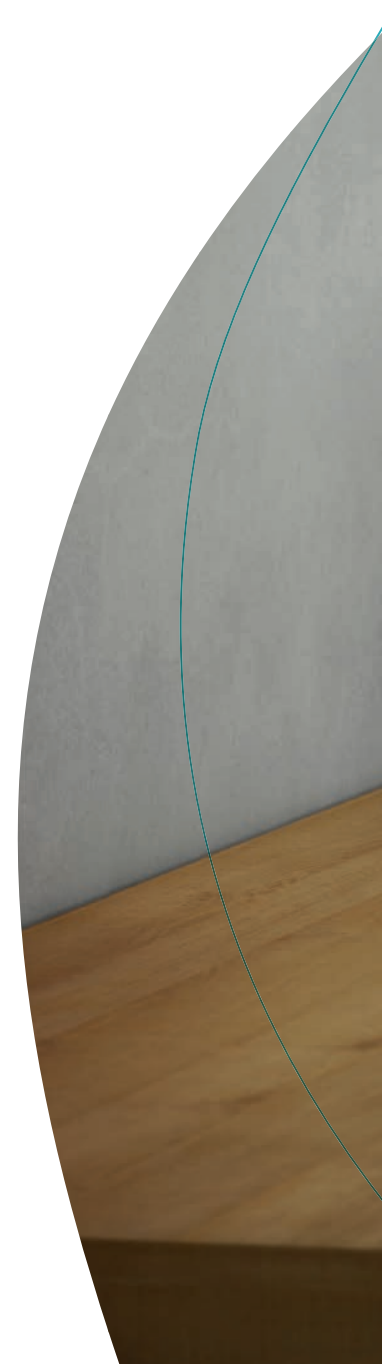



New Regent Classic | Cromo | Chromed



Ref.: 68506 09 45 66
 Monobloc de lavabo cromo
 Chromed wash-basin mixer



Ref.: 68516 09 45 66
 Monobloc de bidé cromo
 Chromed bidet mixer

New Regent Classic | Cromo | Chromed



Ref.: 68526 09 45 66
 Mezclador de baño cromo con kit
 Chromed bath mixer with kit



Ref.: 68531 09 45 66
 Mezclador de ducha cromo con kit
 Chromed shower mixer with kit



Ref.: 100196 45 00
 Mango de ducha New Regent cromo
 New Regent chromed hand shower
Ref.: 100135 60 00
 Flexo H 1/2" - H 1/2" 1,70 m inoxidable
 F 1/2" - F 1/2" Stainless steel flexible hose 1.70 m
Ref.: 1647 45
 Soporte ducha Clásico
 Classic shower holder
Soporte ducha Clásico | Classic shower holder

New Regent Classic | Bronce | Bronze



Ref.: 68506 09 43 66
 Monobloc de lavabo bronce
 Wash-basin mixer bronze



Ref.: 68516 09 43 66
 Monobloc bidet bronce
 Bronze bidet mixer

New Regent Classic | Bronce | Bronze



Ref.: 68526 09 43 66
 Mezclador de baño bronce con kit
 Bronze bath mixer with kit



Ref.: 68531 09 43 66
 Mezclador de ducha bronce con kit
 Bronze shower mixer with kit



Ref.: 100196 43 00
 Mango de ducha New Regent bronce
 New Regent bronze hand shower
Ref.: 100135 43 00
 Flexo H 1/2" - H 1/2" bronce 170 cm
 F 1/2" - F 1/2" bronce 170 cm flexible hose
Ref.: 1647 43

New Regent Classic | Cocina | Kitchen



Ref.: 68595 09 45 66
Monobloc de fregadera cromo
Chromed sink mixer



Ref.: 68595 09 43 66
Monobloc de fregadera bronce
Bronze sink mixer

New Regent Classic | Cocina | Kitchen



Ref.: 68201 39 45 66
Monomando de fregadera cromo
Chromed sink mixer

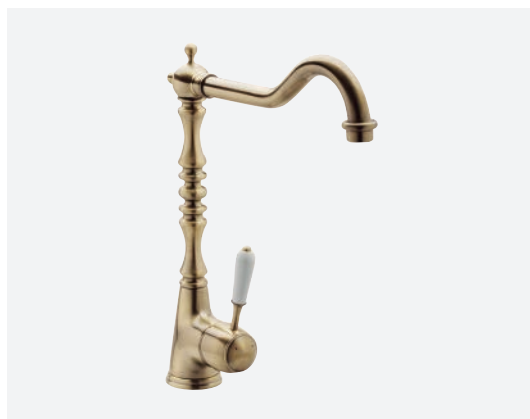

Ref.: 68201 39 43 66
Monomando de fregadera bronce
Bronze sink mixer



New Regent

Romanticismo contemporáneo

De líneas más simples pero igualmente evocadoras, esta seductora colección mantiene parte del encanto y glamour de NewRegentClassic. Sus formas curvilíneas y sus volantes en cruz recuerdan tiempos pasados y aportan un aire de moderno romanticismo a cualquier ambiente.

Contemporary romanticism

The more simple but equally evocative lines of this seductive collection, maintain part of the charm and glamour of NewRegentClassic. Its curvaceous forms and cross-handled taps reflect bygone times and provide an air of modern romanticism to any surroundings.

Acabado cromado. Montura 1/4 vuelta
cierre cerámico
Chromed finish. Ceramic headwork
quarter turn



New Regent | Monobloc lavabo | Wash-basin mixers



Ref.: 68505 09 45 66
Monobloc de lavabo
Wash-basin mixer



Ref.: 68510 09 45 66
Bateria lavabo
Widespread wash-basin mixer



Ref.: 68120 09 45 66
Bateria lavabo
Widespread wash-basin mixer

New Regent | Monobloc lavabo | Wash-basin mixers



Ref.: 68511 09 45 66
Mezclador lavabo 4"
Wash-basin mixer 4"



Ref.: 68500 09 45 66
Grifo lavabo
Wash-basin tap



New Regent | Monobloc bidé | Bidet mixers



Ref.: 68515 09 45 66
Monobloc de bidé
Bidet mixer



Ref.: 68520 09 45 66
Grifo bidé
Bidet tap



Ref.: 68142 09 45 66
Batería de bidé con transmisión
Widespread bidet mixed with transmission

New Regent | Baño y ducha | Bath & shower mixers



Ref.: 68525 09 45 66
Mezclador de baño con kit
Bath mixer with kit



Ref.: 68530 09 45 66
Mezclador de ducha con kit
Shower mixer with kit



Ref.: 100175 45 00
Mango de ducha E1 jet
E1 jet handshower
Ref.: 100135 60 00
Flexo H 1/2" - H 1/2" 1,70 m inoxidable
F 1/2" - F 1/2" Stainless steel flexible hose 1.70 m
Ref.: 100152 45 00
Soporte ducha Combi
Combi shower holder

New Regent | Empotrados | Built-in mixers



Ref.: 68131 09 45 66
 Grupo de lavabo empotrado
 Built-in wash-basin mixer



Ref.: 68535 09 45 66
 Grupo ducha empotrado 8"
 Built-in 8" shower mixer



Ref.: 68527 09 45 66
 Grupo baño empotrado 8" con inversor
 Built-in 8" bath mixer with diverter

New Regent | Llave de paso | **New Regent** | Teleducha | Bidet shower
 Stopcock



Ref.: 68590 09 45 66
 Llave de paso 1/2"
 Stopcock 1/2"



Ref.: 68001 09 45 66
 Grifo de bidé con teleducha
 Bidet tap with shower

New Regent | Cocina | Kitchen



Ref.: 68540 09 45 66
Monobloc fregadera caño tubo
Sink mixer, swan neck spout



Ref.: 68550 09 45 66
Grupo mural fregadera 11 cm caño tubo alto 18 cm
Wall sink mixer with 11 cm high tube, 18 cm spout



Ref.: 68196 09 45 66
Grupo mural fregadera 11 cm caño tubo alto 24 cm
Wall sink mixer with 11cm high tube, 24 cm spout

New Regent | Cocina | Kitchen



Ref.: 68555 09 45 66
Grupo mural fregadera 15 cm caño tubo alto 24 cm
Wall sink mixer with 15 cm with high tube, 24 cm spout



Ref.: 68560 09 45 66
Grupo mural fregadera 15 cm caño tubo bajo 24 cm
Wall sink mixer with 15cm low tube, 24 cm spout



Ref.: 68565 09 45 66
Grupo mural fregadera 20 cm caño tubo alto 24 cm
20 cm wall sink mixer with high tube, 24 cm spout

New Regent | Cocina | Kitchen



Ref.: 68570 09 45 66
 Grupo mural fregadera 20 cm caño tubo alto vertical
 vertical
 20 cm wall sink mixer with swan neck spout



Ref.: 68194 09 45 66
 Mezclador mesada 6" caño tubo
 6" deck mixer with swan neck spout



Ref.: 68545 09 45 66
 Mezclador mesada 8" caño tubo
 8" deck mixer with swan neck spout

New Regent | Cocina | Kitchen



Ref.: 68585 09 45 66
 Grifo fregadera encimera caño tubo vertical
 Deck sink tap with swan neck spout



Ref.: 68575 09 45 66
 Grifo fregadera mural caño tubo vertical
 Wall sink tap with swan neck spout



Ref.: 68580 09 45 66
 Grifo mural fregadera caño tubo alto 24 cm
 Wall sink tap with tube spout 24 cm

New Regent | Cocina | Kitchen



Ref.: 568550 45
Cuerpo grupo mural 11 cm
Wall body mixer 11 cm



Ref.: 568555 45
Cuerpo grupo mural 15 cm
Wall body mixer 15 cm

New Regent | Cocina | Kitchen



Ref.: 568565 45
Cuerpo grupo mural 20 cm
Wall body mixer 20 cm



Ref.: 568575 45
Cuerpo grifo mural
Wall body tap

New Regent | Cocina | Kitchen



Ref.: 68901 45
 Caño alto tubo 18 cm
 High tube spout 18 cm
Ref.: 68902 45
 Caño alto tubo 24 cm
 High tube spout 24 cm
Ref.: 68908 45
 Caño alto tubo 30 cm
 High tube spout 30 cm



Ref.: 68910 45
 Caño bajo tubo 18 cm
 Low tube spout 18 cm
Ref.: 68904 45
 Caño bajo tubo 24 cm
 Low tube spout 24 cm
Ref.: 68909 45
 Caño bajo tubo 30 cm
 Low tube spout 30 cm



Ref.: 68903 45
 Caño tubo vertical
 Swan neck spout

Gamma

Serena calidad

El perfecto equilibrio entre la serenidad del diseño y la calidad se encuentra en esta colección Gamma. Sobria y discreta, su tirador bimando y sus características clásicas, están ideadas para espacios centrados en la funcionalidad.

Serene quality

A perfect balance between the serenity of the design and its quality, can be found in this Gamma collection. Simple and discreet, its two-handle tap and classical characteristics are intended for spaces focused on functionality.

Acabado cromado. Montura convencional
Chromed finish. Conventional headwork

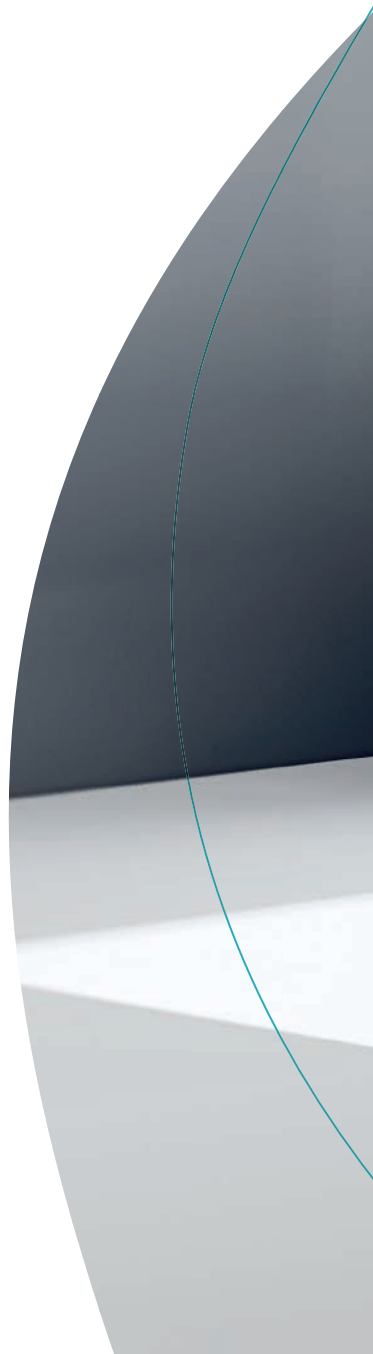



Gamma | Monobloc lavabo | Wash-basin mixers



Ref.: 68130 11 45 66
Monobloc de lavabo
Wash-basin mixer



Ref.: 68120 11 45 66
Bateria de lavabo
Widespread wash-basin mixer

Gamma | Monobloc lavabo | Wash-basin mixers



Ref.: 68122 11 45 66
Mezclador lavabo 4"
Wash-basin mixer 4"



Ref.: 68180 11 45 66
Grifo de lavabo
Wash-basin tap

Gamma | Monobloc bidé | Bath & shower



Ref.: 68140 11 45 66
Monobloc de bidé
Bidet mixer



Ref.: 68160 11 45 66
Grifo bidé
Bidet tap



Ref.: 68142 11 45 66
Bateria de bidé con transmisión
Widespread bidet mixer with transmission

Gamma | Baño y ducha | Bath & shower mixer



Ref.: 68100 11 45 66
Mezclador de baño con kit
Bath mixer with kit



Ref.: 68110 11 45 66
Mezclador de ducha con kit
Shower mixer with kit



Ref.: 100175 45 00
Mango de ducha E1 jet
E1 jet handshower
Ref.: 100135 60 00

Ref.: 100152 45 00
Soporte ducha Combi
Combi shower holder

Gamma | Empotrados | Built-in mixers



Ref.: 68131 11 45 66
Grupo de lavabo empotrado
Built-in wash-basin



Ref.: 68115 11 45 66
Grupo ducha empotrado 8"
Built-in 8" shower mixer



Ref.: 68116 11 45 66
Grupo baño empotrado 8" con inversor
Built-in 8" bath mixer with diverter

Gamma | Llave de paso |
Stopcock



Ref.: 68170 11 45 66
Llave de paso 1/2"
Stopcock 1/2"

Gamma | Teleducha bidé | Bidet shower



Ref.: 68001 11 45 66
Grifo de bidé con teleducha
Bidet tap with shower

Gamma | Cocina | Kitchen



Ref.: 68200 11 45 66
 Monobloc de fregadera caño tubo
 Sink mixer, swan neck spout



Ref.: 68195 11 45 66
 Grupo mural fregadera 11 cm caño tubo alto 18 cm
 Wall sink mixer with 11cm high tube, 18 cm spout



Ref.: 68196 11 45 66
 Grupo mural fregadera 11 cm caño tubo alto 24 cm
 Wall sink mixer with 11 cm, high tube 24 cm spout

Gamma | Cocina | Kitchen



Ref.: 68190 11 45 66
 Grupo mural fregadera 15 cm caño tubo alto 18 cm
 Wall sink mixer with 15 cm, high tube, 18 cm spout



Ref.: 68193 11 45 66
 Grupo mural fregadera 15 cm caño tubo alto 24 cm
 Wall sink mixer with 15 cm with high tube, 24 cm spout



Ref.: 68197 11 45 66
 Grupo mural fregadera 15 cm caño tubo bajo 24 cm
 Wall sink mixer with 15cm low tube, 24 cm spout

Gamma | Cocina | Kitchen



Ref.: 68103 11 45 66
Grupo mural fregadera 20 cm caño tubo alto vertical
20 cm wall sink mixer with swan neck spout



Ref.: 68104 11 45 66
Grupo mural fregadera 20 cm caño tubo alto 24 cm
20 cm wall sink mixer with high tube, 24 cm spout

Gamma | Cocina | Kitchen



Ref.: 68093 11 45 66
Grifo mural fregadera caño tubo alto 24 cm
Wall sink tap with tube spout 24 cm



Ref.: 68003 11 45 66
Grifo fregadera encimera caño tubo vertical
Deck sink tap with swan neck spout



Ref.: 68083 11 45 66
Grifo fregadera mural caño tubo vertical
Wall sink tap with swan neck spout

Gamma | Cocina | Kitchen



Ref.: 68194 11 45 66
Mezclador mesada 6" caño tubo
6" deck mixer with swan neck spout



Ref.: 68199 11 45 66
Mezclador mesada 8" caño tubo
8" deck mixer with swan neck spout

Gamma | Cocina | Kitchen



Ref.: 568195 45
Cuerpo grupo mural 11 cm
Wall body mixer 11 cm



Ref.: 568193 45
Cuerpo grupo mural 15 cm
Wall body mixer 15 cm

Gamma | Cocina | Kitchen



Ref.: 568104 45
Cuerpo grupo mural 20 cm
Wall body mixer 20 cm



Ref.: 568083 45
Cuerpo grifo mural
Wall body tap

Gamma | Cocina | Kitchen



Ref.: 68901 45
Caño alto tubo 18 cm
High tube spout 18 cm

Ref.: 68902 45
Caño alto tubo 24 cm
High tube spout 24 cm

Ref.: 68908 45
Caño alto tubo 30 cm
High tube spout 30 cm



Ref.: 68910 45
Caño bajo tubo 18 cm
Low tube spout 18 cm

Ref.: 68904 45
Caño bajo tubo 24 cm
Low tube spout 24 cm

Ref.: 68909 45
Caño bajo tubo 30 cm
Low tube spout 30 cm



Ref.: 68903 45
Caño tubo vertical
Swan neck spout



GENEBRE

Kalo

Flexibilidad absoluta

De formas elegantes y sencillas, esta versátil propuesta permite distintas combinaciones para crear espacios únicos y ambientes muy personales. Las tres series de grifería bimando conjuntan de manera excelente con la variedad de caños y volantes Kalo, Kross e Ixo.

Absolute flexibility

With elegant and simple shapes, this versatile proposal provides different combinations, for creating a unique space and very personal surroundings. The three series of two-handle taps combine excellently with the variety of Kalo, Kross and Ixo spouts and handles.

Acabado cromado. Montura 1/4 vuelta
cierre cerámico
Chromed finish. Ceramic headwork
quarter turn





Kalo | Batería de lavabo | Widespread wash-basin mixers



Ref.: 68120 07 45 66
Batería de lavabo caño recto
Widespread wash-basin mixer with straight pipe spout



Ref.: 68124 07 45 66
Batería de lavabo caño cisne
Widespread wash-basin mixer with swan pipe spout



Ref.: 68125 07 45 66
Batería de lavabo caño inclinado
Widespread wash-basin mixer with sloping pipe spout

Kalo | Lavabo empotrado | Built-in wash-basin mixers



Ref.: 68131 07 45 66
Grupo de lavabo empotrado caño 16 cm
Built-in wash-basin mixer with 16 cm pipe spout



Ref.: 68132 07 45 66
Grupo de lavabo empotrado caño 22 cm
Built-in wash-basin with 22 cm pipe spout

Kalo | Inversor | Diverter



Ref.: 63114 30 45 66

Inversor cerámico 3 vías empotrado placa redonda
Built-in 3 way ceramic diverter with round plate

Las series Kalo, Kross y Ixo nacen de la combinación de diferentes componentes: cuerpos, caños y volantes.

Busque la combinación que mejor se adapte a su baño.

Puede pedirla utilizando la referencia del catálogo (conjunto) o bien por referencia de cada uno de los componentes (ver información técnica pagina 231).

The series Kalo, Kross and Ixo are born from the combination of different components: bodies, pipes and handles.

Look for the combination that best suits your bathroom.

You can order it using the set reference or by components reference (see technical information page 231).

Kalo | Baño y ducha empotrado | Built-in bath & shower mixers

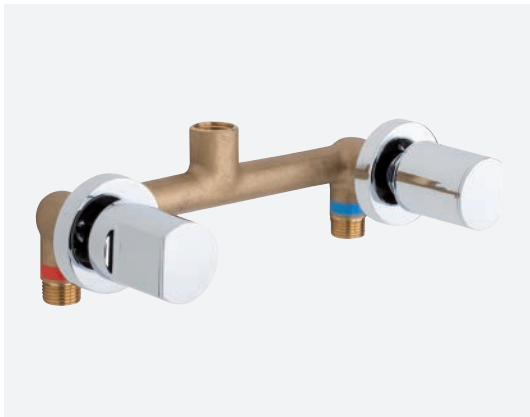

Ref.: 68115 07 45 66

Grupo ducha empotrado 8"
Built-in 8" shower mixer



Ref.: 68116 07 45 66

Grupo baño empotrado 8" con inversor
Built-in 8" bath mixer with diverter



Ref.: 68113 07 45 66

Batería de baño con inversor
Widespread bath mixer with diverter

Kalo | Bateria de bidé | Widespread bidet mixer



Ref.: 68142 07 45 66
Bateria de bidé con transmisión
Widespread bidet mixer with transmission

Kalo | Llave de paso | Stopcock



Ref.: 68170 07 45 66
Llave de paso 1/2"
Stopcock 1/2"





Kross

Variedad y estilo

Las posibilidades son innumerables en esta colección diseñada para destacar los volantes en los baños más sofisticados. Los diferentes tipos de caño y las múltiples opciones se adaptan a la perfección a distintos ambientes y estilos.

Variety and style

This collection designed to showcase handles in the most sophisticated of bathrooms, provides you with countless possibilities. The different types of spouts and multiple options, adapt perfectly to distinct styles and spaces.

Acabado cromado. Montura 1/4 vuelta
cierre cerámico
Chromed finish. Ceramic headwork
quarter turn

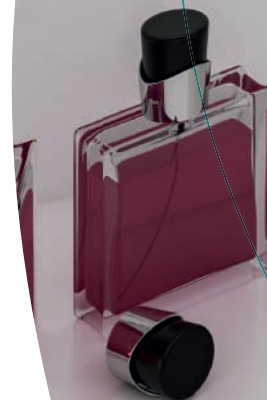



Kross | Batería de lavabo | Widespread wash-basin mixers



Ref.: 68120 08 45 66
Batería de lavabo caño recto
Widespread wash-basin mixer with straight pipe spout



Ref.: 68124 08 45 66
Batería de lavabo caño cisne
Widespread wash-basin mixer with swan pipe spout



Ref.: 68125 08 45 66
Batería de lavabo caño inclinado
Widespread wash-basin mixer with sloping pipe spout

Kross | Lavabo empotrado | Built-in wash-basin mixers



Ref.: 68131 08 45 66
Grupo de lavabo empotrado caño 16 cm
Built-in wash-basin mixer with 16 cm pipe spout



Ref.: 68132 08 45 66
Grupo de lavabo empotrado caño 22 cm
Built-in wash-basin mixer with 22cm pipe spout

Kross | Inversor | Diverter



Ref.: 63114 30 45 66
 Inversor cerámico 3 vías empotrado placa redonda
 Built-in 3 way ceramic diverter with round plate

Las series Kalo, Kross y Ixo nacen de la combinación de diferentes componentes: cuerpos, caños y volantes.
 Busque la combinación que mejor se adapte a su baño.
 Puede pedirla utilizando la referencia del catálogo (conjunto) o bien por referencia de cada uno de los componentes (ver información técnica pagina 233).

The series Kalo, Kross and Ixo are born from the combination of different components: bodies, pipes and handles.
 Look for the combination that best suits your bathroom.
 You can order it using the set reference or by components reference (see technical information page 233).

Kross | Baño y ducha empotrado | Built-in bath & shower mixers

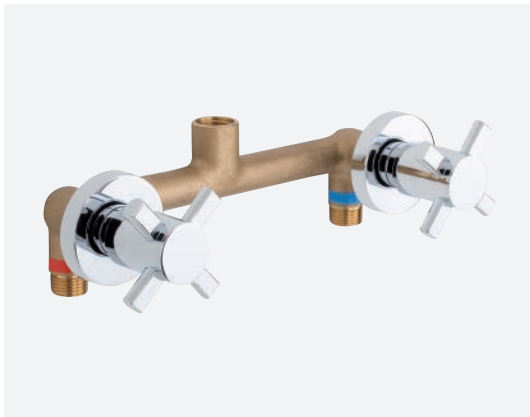

Ref.: 68115 08 45 66
 Grupo ducha empotrado 8"
 Built-in 8" shower mixer



Ref.: 68116 08 45 66
 Grupo ducha empotrado 8" con inversor
 Built-in 8" bath mixer with diverter



Ref.: 68113 08 45 66
 Batería de baño con inversor
 Widespread bath mixer with diverter

Kross | Batería de bidé | Widespread bidet mixer



Ref.: 68142 08 45 66

Batería de bidé con transmisión
Widespread bidet mixer with transmission

Kross | Llave de paso | Stopcock



Ref.: 68170 08 45 66

Llave de paso 1/2"
Stopcock 1/2"





Ixo

Infinitas posibilidades

Las formas llamativamente esbeltas y geométricas de los volantes de la colección Ixo crean bellas combinaciones con las numerosas alternativas de caños. El diseño, diferente y actual, crea una especial fusión entre el estilo clásico y el minimalista.

Endless possibilities

The slender and geometric eye-catching shapes of the handles of the Ixo collection, can be beautifully combined with numerous spout options. This different and on-trend design creates a special fusion between classical and minimalist styles.

Acabado cromado. Montura 1/4 vuelta
cierre cerámico
Chromed finish. Ceramic headwork
quarter turn





Ixo | Batería de lavabo | Widespread wash-basin mixers



Ref.: 68120 12 45 66
Batería de lavabo caño recto
Widespread wash-basin mixer with straight pipe spout



Ref.: 68124 12 45 66
Batería de lavabo caño cisne
Widespread wash-basin mixer with swan pipe spout



Ref.: 68125 12 45 66
Batería de lavabo caño inclinado
Widespread wash-basin mixer with sloping pipe spout

Ixo | Lavabo empotrado | Built-in wash-basin mixers



Ref.: 68131 12 45 66
Grupo de lavabo empotrado caño 16 cm
Built-in wash-basin mixer with 16 cm pipe spout



Ref.: 68132 12 45 66
Grupo de lavabo empotrado caño 22 cm
Built-in wash-basin mixer with 22 cm pipe spout

Ixo | Inversor | Diverter



Ref.: 63114 30 45 66

Inversor cerámico 3 vías empotrado placa redonda
Built-in 3 way ceramic diverter with round plate

Las series Kalo, Kross y Ixo nacen de la combinación de diferentes componentes: cuerpos, caños y volantes.
Busque la combinación que mejor se adapte a su baño.
Puede pedirla utilizando la referencia del catálogo (conjunto) o bien por referencia de cada uno de los componentes (ver información técnica pagina 235).

The series Kalo, Kross and Ixo are born from the combination of different components: bodies, pipes and handles.
Look for the combination that best suits your bathroom.
You can order it using the set reference or by components reference (see technical information page 235).

Ixo | Baño y ducha empotrado | Built-in bath & shower mixers

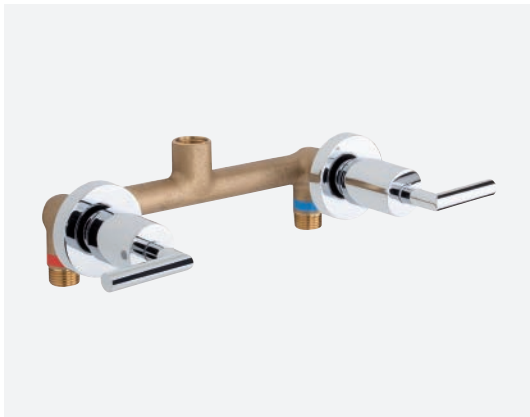

Ref.: 68115 12 45 66

Grupo ducha empotrado 8"
Built-in 8" shower mixer

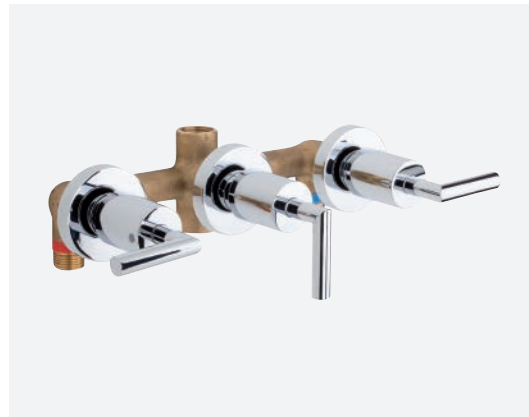

Ref.: 68116 12 45 66

Grupo ducha empotrado 8" con inversor
Built-in 8" shower mixer with diverter



ixo | Batería de bidé | Widespread bidet mixer



Ref.: 68113 12 45 66
Batería de baño con inversor
Widespread bath mixer with diverter



Ref.: 68142 12 45 66
Batería de bidé con transmisión
Widespread bidet mixer with transmission

ixo | Llave de paso | Stopcock



Ref.: 68170 12 45 66
Llave de paso 1/2"
Stopcock 1/2"

Style Shower

Duchas versátiles

Convertir la ducha en un espacio de bienestar personal es posible gracias a esta colección donde cada pieza es un diseño inteligente y versátil. En GENE BRE ponemos a tu disposición una gran variedad de accesorios, complementos y mangos de duchas perfectos para cada modelo.

Versatile showers

Converting your shower into a space of personal well-being is possible, thanks to this collection where each piece has an intelligent and versatile design. At GENE BRE we make a wide variety of shower hoses, accessories and add-ons available to you, perfect for every shower model.

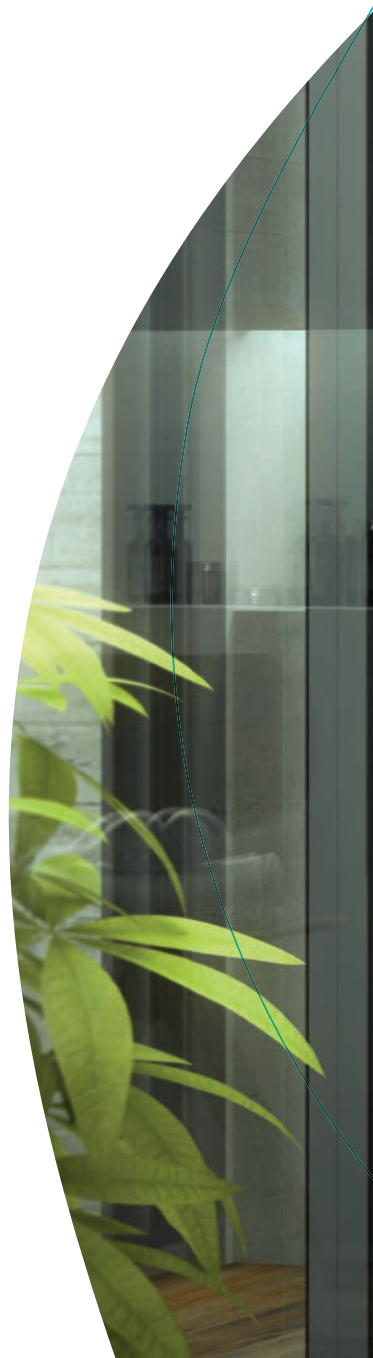



Style shower



Ref.: 65114 30 45 66
 Inversor cerámico 3 vías empotrado con placa cuadrada
 Built-in 3-way ceramic diverter with square plate
Ref.: 65115 18 45 66
 Monomando de ducha empotrado
 Built-in single lever shower mixer
Ref.: 1643 45
 Rociador doble función cascada-lluvia
 Shower head double function waterfall-rain
Ref.: 1680 04
 Toma ducha mural redonda
 Round wall flexible connector
Ref.: 1748 45
 Conjunto Tau, barra, flexo y ducha 5 jets
 Tau set, bar, hose and 5 jets handshower



Ref.: 63116 26 45 66
 Monomando de baño empotrado con inversor
 Built-in single lever bath with mixer with diverter
Ref.: 1672 45
 Brazo a techo cuadrado 15 cm
 Square roof arm 15 cm
Ref.: R63112 26
 Rociador cuadrado 22 cm
 Square shower head 22 cm
Ref.: 1679 04
 Toma ducha mural cuadrada
 Square wall flexible connector
Ref.: 1747 45
 Conjunto Kenjo, barra, flexo y ducha 3 jets
 Kenjo set, bar, flexible hose and 3 jets handshower



Ref.: 65118 18 45 66
 Monomando empotrado con inversor cerámico 3 vías
 Built-in single lever mixer with 3-way ceramic diverter
Ref.: B65113 18
 Brazo pared redondo 35 cm
 Round wall arm 35 cm
Ref.: R65112 18
 Rociador redondo 22 cm
 Round shower head 22 cm
Ref.: 1680 04
 Toma ducha mural redonda
 Round wall flexible connector
Ref.: 1748 45
 Conjunto Tau, barra, flexo y ducha 5 jets
 Tau set, bar, hose and 5 jets handshower
Ref.: 1668 45
 Caño mural baño cilíndrico
 Round wall bath spout



Style shower



Ref.: 64118 04 45 66

Monomando empotrado con inversor cerámico 3 vías

Built-in single handle mixer with 3-way ceramic diverter

Ref.: 1671 45

Brazo a techo redondo 15 cm

Round roof arm 15 cm

Ref.: R65112 18

Rociador redondo 22 cm

Round shower head 22 cm

Ref.: 1680 04

Toma ducha mural redonda

Round wall flexible connector

Ref.: 1639 45

Barra ducha metálica

Metallic shower bar

Ref.: 100140 30

Flexo H 1/2" - H 1/2" 1,70 m. PVC antirrotura

F 1/2" - F 1/2" PVC flexible hose 1.70 m anti-breaking

Ref.: DXT3 45

Mango de ducha T3 jets

T3 jets handshower

Ref.: 1668 45

Caño mural baño cilíndrico

Round wall bath spout



Ref.: 63100 26 45 67

Monomando de baño sin kit

Single lever bath mixer without kit

Ref.: 1746 45

Set columna extensible con ducha, soporte y flexo

Extendible column set with shower, holder and flexible hose



Ref.: 67110 26 45 67

Termostática ducha sin kit

Thermostatic shower mixer without kit

Ref.: 1746 45

Set columna extensible con ducha, soporte y flexo

Extendible column set with shower, holder and flexible hose





Style shower



Ref.: 64115 16 45 66
Monomando de ducha empotrado
Built-in single lever shower mixer

Ref.: 1680 04
Toma ducha mural redonda
Round wall flexible connector

Ref.: 1745 45
Set columna extensible con ducha, soporte y flexo
Extensible column set with shower, holder and flexible hose



Ref.: 68115 08 45 66
Grupo ducha empotrado 8"
Built-in 8" shower mixer

Ref.: 1680 04

Ref.: 1745 45
Set columna extensible con ducha, soporte y flexo
Extensible column set with shower, holder and flexible hose

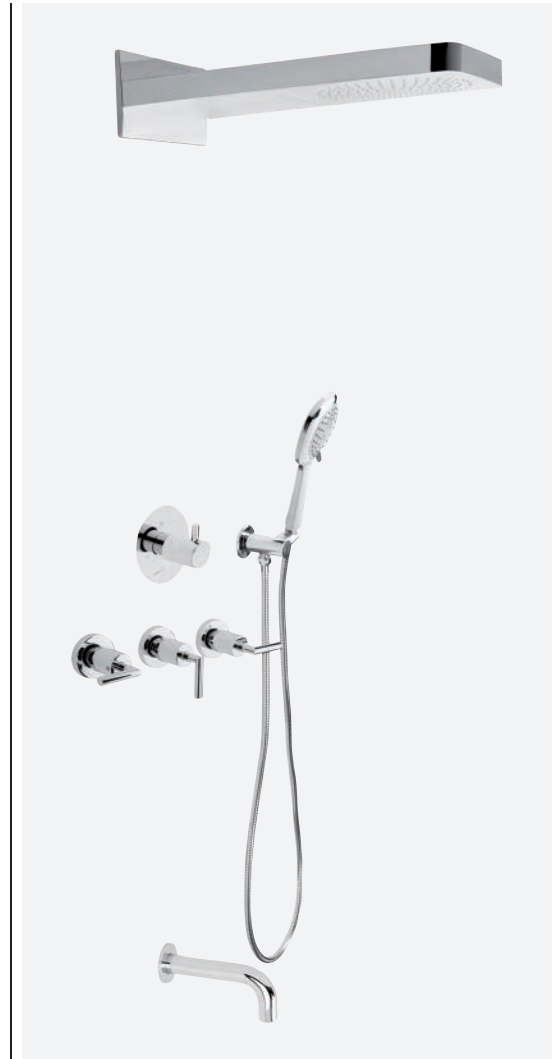

Ref.: 68116 12 45 66
Grupo ducha empotrado 8" con inversor
Built-in 8" shower mixer with diverter

Ref.: 63114 30 45 66
Inversor cerámico 3 vías empotrado placa redonda
Built-in 3 way ceramic diverter with round plate

Ref.: 1643 45
Rociador doble función cascada-lluvia
Shower head double function waterfall-rain

Ref.: 1633 04
Soporte ducha con toma cilíndrico
Round flexible wall conector

Ref.: 100137 60 00
Flexo extensible H 1/2" - H 1/2" 1,70 - 2,25 m inoxidable
F 1/2" - F 1/2" Extensible stainless steel flexible hose 1.70 to 2.25 m

Ref.: DXT3 45
Mango de ducha T3 jets
T3 jets handshower

Ref.: 1668 45
Caño mural baño cilíndrico
Round wall bath spout



Style shower

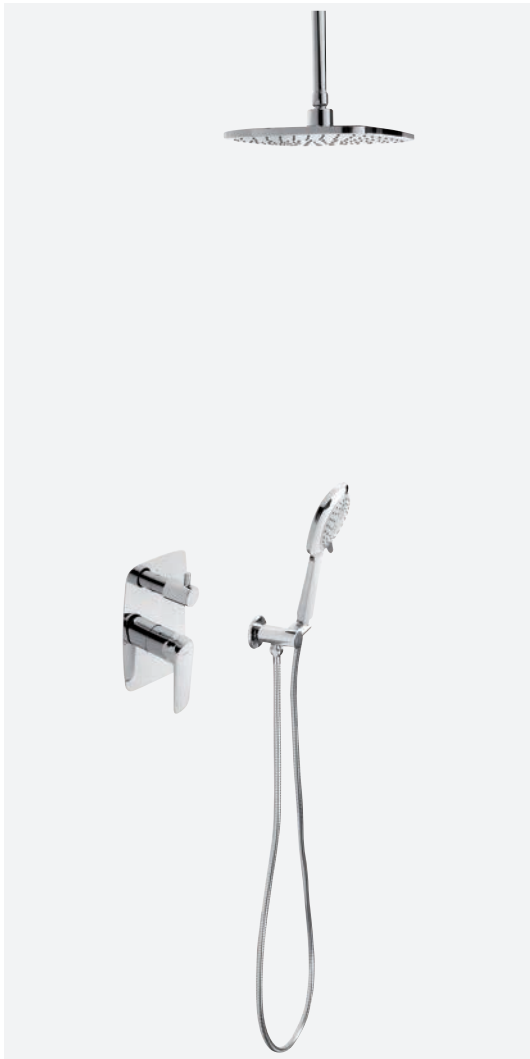

Ref.: 62117 31 45 66

Monomando empotrado con inversor cerámico 2 vías

Built-in single lever mixer with 2 way ceramic diverter

Ref.: 1671 45

Brazo a techo redondo 15 cm

Round roof arm 15 cm

Ref.: R65112 08

Rociador ovalado 22 cm

Oval shower head 22 cm

Ref.: 1633 04

Soporte ducha con toma cilíndrico

Round flexible wall conector

Ref.: 100137 60 00

Flexo extensible H 1/2" - H 1/2" 1,70 - 2,25 m inoxidable

F 1/2" - F 1/2" Extensible stainless steel flexible hose 1.70 to 2.25 m

Ref.: DX03 45

Mango de ducha O3 jets

O3 jets handshower



Ref.: 64116 14 45 66

Monomando de baño empotrado con inversor

Built-in single lever bath mixer with diverter

Ref.: B65113 18

Brazo pared redondo 35 cm

Round wall arm 35 cm

Ref.: R63112 26

Rociador cuadrado 22 cm

Square shower head 22 cm

Ref.: 1668 45

Caño mural baño cilíndrico

Round wall bath spout



Ref.: 63116 26 45 66

Monomando de baño empotrado con inversor

Built-in single lever bath with mixer with diverter

Ref.: B63113 26

Brazo pared cuadrado 35 cm

Square wall arm 35 cm

Ref.: R63112 26

Rociador cuadrado 22 cm

Square shower head 22 cm

Ref.: 1674 45

Caño mural baño cuadrado

Square wall bath spout



Accesorios

Accessories

Un toque personal

La selección cuidadosa de los detalles transmite personalidad. Con GENE BRE resulta posible combinar los modelos de grifería con una amplia variedad de accesorios y complementos, funcionales y decorativos, para aportar un toque propio a cada baño.

A personal touch

Carefully selected details transmit personality. At GENE BRE, it is possible to combine tap models with a wide range of functional and decorative add-ons and accessories, to give your own personal touch to each bathroom.

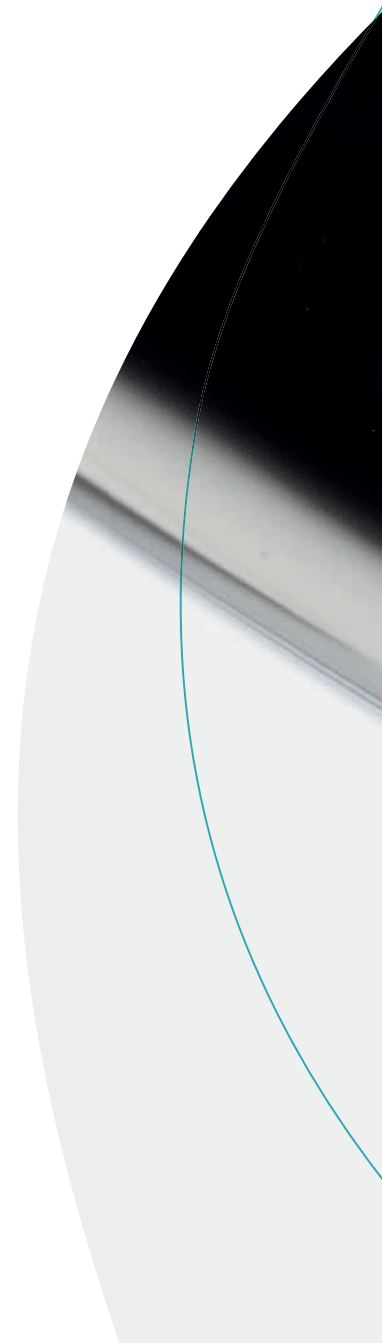



Accesorios | Mangos de ducha | Accessories | Handshowers



Ref.: DXK3 45
Mango de ducha K3 jets
K3 jets handshower



Ref.: DXT5 45
Mango de ducha T5 jets
T5 jets handshower



Ref.: DXT3 45
Mango de ducha T3 jets
T3 jets handshower

Accesorios | Mangos de ducha | Accessories | Handshowers



Ref.: DXO3 45
Mango de ducha O3 jets
O3 jets handshower



Ref.: DXE5 45
Mango de ducha E5 jets
E5 jets handshower



Ref.: DXE2 45
Mango de ducha E2 jets
E2 jets handshower

Accesorios | Mangos de ducha | Accessories | Handshowers



Ref.: DXK1 45
Mango de ducha K1 jets
K1 jet handshower



Ref.: 100197 45 00
Mango de ducha C1 jet
C1 jet handshower



Ref.: 100175 45 00
Mango de ducha E1 jet
E1 jet handshower

Accesorios | Kits de ducha | Accessories | Shower kits



Ref.: 100698 45
Kit de ducha Kenjo, flexo, soporte y ducha 3 jets
Kenjo shower set, flexible hose, holder and 3 jets
handshower



Ref.: 100699 45
Kit de ducha Tau, flexo, soporte y ducha 5 jets
Tau shower set, flexible hose, holder and 5 jets
handshower



Ref.: 100697 45
Kit de ducha GE2, flexo, soporte y ducha 1 jet
GE2 shower set, flexible hose, holder and 1 jet
handshower

Accesorios | Conjuntos barra | Accessories | Bar sets



Ref.: 1748 45
Conjunto Tau, barra, flexo y ducha 5 jets
Tau set, bar, hose and 5 jets handshower



Ref.: 1747 45
Conjunto Kenjo, barra, flexo y ducha 3 jets
Kenjo set, bar, flexible hose and 3 jets handshower



Ref.: 1636 45
Barra ducha TAU
TAU shower bar

Accesorios | Barra ducha | Accessories | Shower bars



Ref.: 1637 45
Barra ducha Kenjo
Kenjo shower bar



Ref.: 1638 45
Barra ducha redonda
Round shower bar



Ref.: 1639 45
Barra ducha metálica
Metallic shower bar

Accesorios | Flexos | Accessories | Flexible hoses



Ref.: 100135 60 00
Flexo H 1/2" - H 1/2" 1,70 m inoxidable
F 1/2" - F 1/2" Stainless steel flexible hose 1.70 m



Ref.: 100137 60 00
Flexo extensible H 1/2" - H 1/2" 1,70 - 2,25 m
inoxidable
F 1/2" - F 1/2" Extensible stainless steel flexible
hose 1.70 to 2.25 m



Ref.: 100140 30
Flexo H 1/2" - H 1/2" 1,70 m. PVC antirrotura
F 1/2" - F 1/2" PVC flexible hose 1.70 m anti-
breaking

Accesorios | Flexos | Accessories | Flexible hoses



Ref.: 100141 45
Flexo H 1/2" - H 1/2" 1,20 m inoxidable
F 1/2" - F 1/2" Stainless steel flexible hose 1.20 m

Accesorios | Soportes ducha | Accessories | Shower holders



Ref.: 100152 45 00
Soporte ducha Combi
Combi shower holder



Ref.: 100149 45
Soporte ducha Kenjo
Kenjo shower holder



Ref.: 100153 45
Soporte ducha cilíndrico
Cylindrical shower holder

Accesorios | Soportes ducha | Accessories | Shower holders



Ref.: 100068 45
Soporte ducha ovalado
Oval shower holder



Ref.: 1633 04
Soporte ducha con toma cilíndrico
Round flexible wall conector



Ref.: 1649 04
Soporte ducha con toma cuadrado
Square flexible wall conector

Accesorios | Tomas de ducha | Accessories | Wall connectors



Ref.: 1680 04
Toma ducha mural redonda
Round wall flexible connector



Ref.: 1679 04
Toma ducha mural cuadrada
Square wall flexible connector

Accesorios | Rociadores y brazos | Accessories | Shower heads and sprayer arms



Ref.: 1643 45
Rociador doble función cascada-lluvia
Shower head double function waterfall-rain



Ref.: R63112 08
Rociador ovalado 22 cm
Oval shower head 22 cm

Ref.: 1671 45
Brazo a techo redondo 15 cm
Round roof arm 15 cm



Ref.: R63112 26
Rociador cuadrado 22 cm
Square shower head 22 cm

Ref.: 1672 45
Brazo a techo cuadrado 15 cm
Square roof arm 15 cm

Accesorios | Rociadores y brazos | Accessories | Shower heads and sprayer arms



Ref.: R65112 18
 Rociador redondo 22 cm
 Round shower head 22 cm
Ref.: 1671 45
 Brazo a techo redondo 15 cm
 Round roof arm 15 cm



Ref.: R63112 08
 Rociador ovalado 22 cm
 Oval shower head 22 cm
Ref.: B65113 18
 Brazo pared redondo 35 cm
 Round wall arm 35 cm

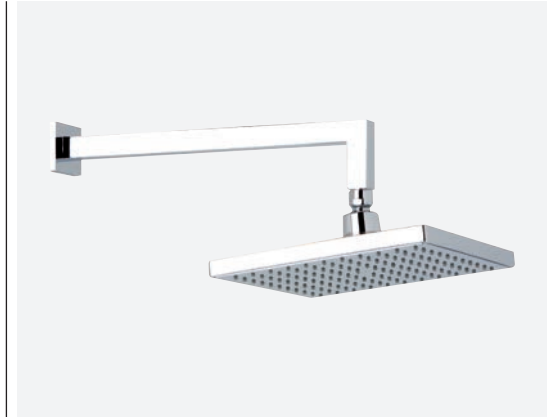

Ref.: R63112 26
 Rociador cuadrado 22 cm
 Square shower head 22 cm
Ref.: B63113 26
 Brazo pared cuadrado 35 cm
 Square wall arm 35 cm

Accesorios | Rociadores y brazos | Accessories | Shower heads and sprayer arms



Ref.: R65112 18
 Rociador redondo 22 cm
 Round shower head 22 cm
Ref.: B65113 18
 Brazo pared redondo 35 cm
 Round wall arm 35 cm



Ref.: 1698 45
 Rociador ducha con brazo
 Wall shower arm and spray



Ref.: 1155 04
 Rociador cilíndrico 10cm
 Cylindrical shower head 10cm
Ref.: B65114 18
 Brazo pared redondo 24 cm
 Round arm 24 cm
Ref.: 1699 45 00

Accesorios | Válvulas de escuadra | Accessories | Angle valves



Ref.: 3104 04
Válvula de escuadra redonda 3/8"
Round angle valve 3/8"

Ref.: 3104 05
Válvula de escuadra redonda 1/2"
Round angle valve 1/2"



Ref.: 3106 04
Válvula de escuadra cuadrada 3/8"
Square angle valve 3/8"

Ref.: 3106 05
Válvula de escuadra cuadrada 1/2"
Square angle valve 1/2"

Accesorios | Válvulas de escuadra | Accessories | Angle valves



Ref.: 3107 03
Válvula de escuadra doble 1/2" - 3/8" ducha-
inodoro
Double angle valve 1/2" - 3/8"

Ref.: 3107 04
Válvula de escuadra doble 1/2" - 1/2" ducha-
inodoro
Double angle valve 1/2" - 1/2"



Ref.: 3108 03
Válvula de escuadra doble 1/2" - 3/8" Inox
SS double angle valve 1/2" - 3/8"

Ref.: 3108 04
Válvula de escuadra doble 1/2" - 1/2" Inox
SS double angle valve 1/2" - 1/2"



Ref.: 3109 04
Válvula de escuadra doble 1/2" - 3/8"
Double angle valve 1/2" - 3/8"

Accesorios | Kits de ducha | Accessories | Shower kits



Ref.: 100694 45
 Kit ducha sanitaria
 Sanitary shower kit



Ref.: 100694 60
 Kit ducha sanitaria inox
 Inox sanitary shower kit



Ref.: 100696 45
 Kit ducha sanitaria
 Sanitary shower kit

Accesorios | Caños lavabo | Accessories | Wash basin spout



Ref.: 1667 45
 Caño mural baño fundido
 Casted wall bath spout



Ref.: 1668 45
 Caño mural baño cilíndrico
 Round wall bath spout



Ref.: 1674 45
 Caño mural baño cuadrado
 Square wall bath spout

Accesorios | Caños lavabo | Accessories | Wash basin spout



Ref.: 68911 45
Caño mural tubo recto 16 cm
Wall mounted pipe spout 16 cm



Ref.: 68912 45
Caño mural tubo recto 22 cm
Wall mounted pipe spout 22 cm



Ref.: 68913 45
Caño mural tubo inclinado 20 cm
Wall mounted sloping pipe spout 20 cm

Accesorios | Caños lavabo | Accessories | Wash basin spout



Ref.: 68914 45
Caño mural tubo retro 20 cm
Wall mounted retro pipe spout 20 cm



Ref.: 68915 45
Caño encimera recto tubo
Straight pipe spout



Ref.: 68916 45
Caño encimera cisne tubo
Swan neck pipe spout

Accesorios | Sifones | Accessories | Siphons



Ref.: 68917 45
Caño encimera inclinado tubo
Sloping pipe spout



Ref.: 1621 07
Sifon botella para lavabo y bidé 1 1/4"
1 1/4" bidet and wash-basin siphon

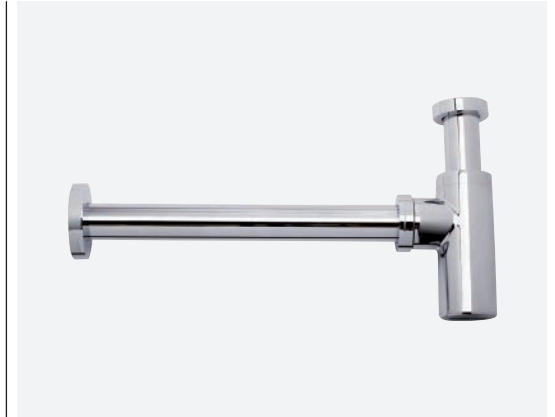

Ref.: 1622 07
Sifon botella para lavabo y bidé 1 1/4"
1 1/4" bidet and wash-basin siphon

Accesorios | Sifones | Accessories | Siphons



Ref.: 100134 07
Tuerca para sifon 1 1/4"
1 1/4" siphon nut



Ref.: 100134 08
Tuerca para sifon 1 1/2"
1 1/2" siphon nut



Ref.: 9908 0046
Adaptador sifon 1 1/4" - 1"
Siphon adaptor 1 1/4" - 1"

Accesorios | Válvulas de desagüe | Accessories | Drain valves



Ref.: 100202 45
Tapa universal "Click remove"
"Click remove" universal cover



Ref.: 100211 45
Válvula click "Luxe" 11/4"
11/4" "Luxe" click valve



Ref.: 100211 43
Válvula click "Luxe" bronce 11/4"
11/4" "Luxe" click valve bronze

Accesorios | Válvulas de desagüe | Accessories | Drain valves



Ref.: 100205 45
Válvula click universal 11/4"
11/4" universal click valve



Ref.: 100204 45
Válvula click Kenjo 11/4"
11/4" Kenjo click valve



Ref.: 100206 45
Válvula click 11/4" con rebodadero
11/4" click valve with overflow

Accesorios | Válvulas de desagüe | Accessories | Drain valves



Ref.: 100207 45
Válvula click 1 1/4"
1 1/4" click valve



Ref.: 100208 45
Válvula click 1 1/4" bañera
1 1/4" bath click valve



Ref.: 100209 45
Válvula click 1 1/4" con/sin rebosadero
1 1/4" click valve with/out overflow

Accesorios | Válvulas de desagüe | Accessories | Drain valves



Ref.: 100210 45
Válvula click 1 1/4" con/sin rebosadero
1 1/4" click valve with/out overflow



Ref.: 100200 45
Válvula automática plástico 1 1/4"
1 1/4" plastic automatic valve



Ref.: 100203 45
Válvula automática metálica 1 1/4"
1 1/4" metallic automatic valve

Accesorios | Accessories |



Ref.: 100122 45
Conjunto florón y excéntricas gigantes
Giant escutcheon eccentric set



Ref.: P130
Placa adaptadora 4"
4" adaptor plate



Ref.: P200
Placa adaptadora 8"
8" adaptor plate



Recambios Spare parts

La importancia del mantenimiento

Mantener el baño en perfecto estado a lo largo del tiempo es esencial. Por este motivo, en GENE BRE te ofrecemos una amplia colección de recambios originales de alta calidad.

The importance of maintenance

Maintaining your bathroom in perfect condition over time is essential. That is why, at GENE BRE we offer you an extensive collection of high quality original spare parts.

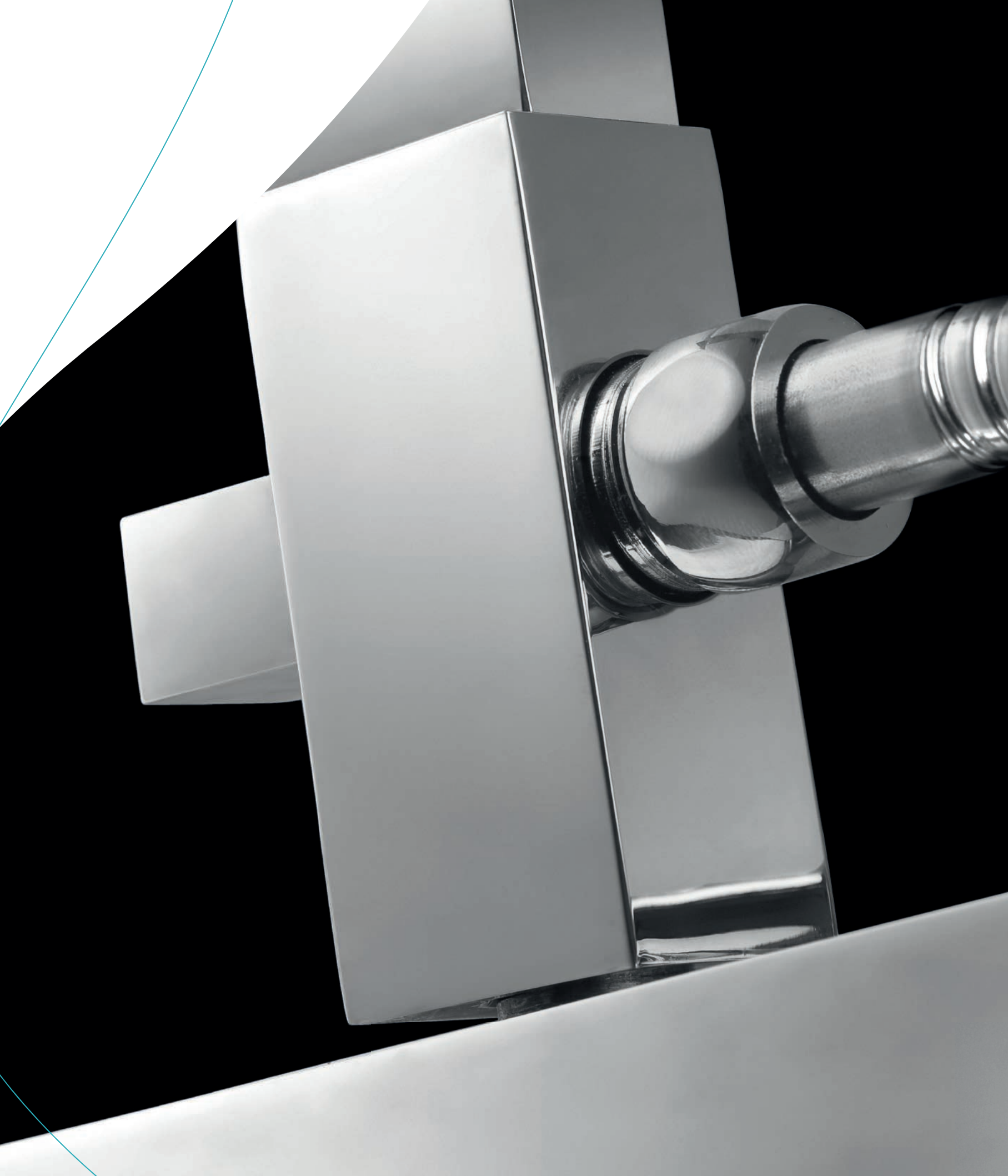

Recambios
Spare parts



Maneta
Handle

Ref.:

100001 05 45
100001 06 45
100001 08 45
100001 14 45
100001 16 45
100001 18 45
100001 19 45
100001 22 45
100001 26 45
100001 28 45
100001 29 45
100001 31 45
100001 33 45
100001F 16 45
100001R 16 45
100001R 19 45
100001V 05 45
100001V 06 45
100001V 14 45
100001V 16 45
100001V 18 45
100001V 19 45
100001V 28 45
100001V 33 45
100001V 37 45
100001V 39 43

100001V 39 45
100001V 40 60
9908 0039
9908 0040
9908 0045
9908 0235
9908 0251

Descripción | Description

Maneta Sara | Sara lever
 Maneta Sigma | Sigma lever
 Maneta Kode | Kode lever
 Maneta Klip 2 | Klip 2 lever
 Maneta Klip | Klip lever
 Maneta Tau | Tau lever
 Maneta Oslo | Oslo lever
 Maneta GE2 | GE2 lever
 Maneta Kenjo | Kenjo lever
 Maneta K8 | K8 lever
 Maneta Tau 2 | Tau 2 lever
 Maneta Kode corta | Short Kode lever
 Maneta GE2 corta | Short GE2 lever
 Maneta Kelogic | Kelogic lever
 Maneta Kelogic marcado vertical | Vertical marked Kelogic lever
 Maneta Oslo marcado vertical apertura en frío | Vertical marked cold Oslo lever
 Maneta Sara marcado vertical | Vertical marked Sara lever
 Maneta Sigma marcado vertical | Vertical marked Sigma lever
 Maneta Klip 2 marcado vertical | Vertical marked Klip2 lever
 Maneta Klip marcado vertical | Vertical marked Klip lever
 Maneta Tau marcado vertical | Vertical marked Tau lever
 Maneta Oslo marcado vertical | Vertical marked Oslo lever
 Maneta K8 marcado vertical | Vertical marked K8 lever
 Maneta GE2 corta marcado vertical | Vertical marked short GE2 lever
 Maneta Tau 35 marcado vertical | Vertical marked Tau 35 lever
 Maneta New Regent marcado vertical bronce | Vertical marked New Regent bronze lever
 Maneta New Regent marcado vertical | Vertical marked New Regent lever
 Maneta Flat | Flat handle
 Maneta FRT65401 | FRT65401 lever
 Maneta FRT65402 | FRT65402 lever
 Maneta FRK | FRK lever
 Maneta inversor columna Oslo | Oslo column diverter lever
 Maneta para 65212 18 45 66 | Lever for 65212 18 45 66

Recambios
Spare parts



Volantes
Handles

Ref.:

- 68988 18**
- 68989 26**
- 68991 14**
- 68992 26**
- 68994 14**
- 68998 07 45**
- 68998 08 45**
- 68998 09 43**
- 68998 09 45**
- 68998 11 45**
- 68998 12 45**
- 68998 28 45**
- 68998 30 45**
- 68998 31 45**
- 9908 0056**
- 9908 0100**
- 9908 0101**
- 9908 0234**
- 9908 0239**
- 9908 0240**
- 9908 0102**
- 9908 0103**
- 100175 45 00**
- 100187 45**
- 100190 45**
- 100196 43 00**
- 100196 45 00**
- 100197 45 00**
- 100199 45**
- 100252 45**
- 100696 45**
- 9908 0255**
- 9908 0260**

Descripción | Description

- Kit volantes columnas termostáticas Tau | Tau thermostatic column handle set
- Kit volantes columnas termostáticas Kenjo | Kenjo thermostatic column handle set
- Kit volantes termostática Tau | Tau thermostatic mixer handle set
- Kit volantes termostáticas Kenjo | Kenjo thermostatic mixer handle set
- Kit volantes termostáticas | Thermostatic mixer handle set
- Volante Kalo | Kalo handle
- Volante Kross | Kross handle
- Volante Regent bronce | Bronze Regent handle
- Volante Regent | Regent handle
- Volante Gamma | Gamma handle
- Volante Ixo | Ixo handle
- Volante Office | Office handle
- Volante Tau | Tau handle
- Volante osmosis | Osmosis handle
- Kit volante termostatica empotrada 2 y 3 vías | Built-in 2 and 3 ways thermostatic handle set
- Cobertor volante termostático | Thermostatic mixer handle cover
- Volante para cartucho termostático | Thermostatic mixer cartridge handle
- Volante inversor set Oslo | Oslo set diverter handle
- Volante montura columna Oslo | Oslo column headwork handle
- Volante cartucho columna Oslo | Oslo column cartridge handle
- Florón para 568120 45 | Scutcheon for 568120 45
- Soporte florón para 568120 45 | Scutcheon support for 568120 45
- Mango de ducha E1 jet | E1 jet handshower
- Mango ducha extraible para 65206 | Pull-out 65206 sink tap sprayer
- Mango ducha de fregadera extraible | Pull-out sink tap sprayer
- Mango de ducha New Regent bronce | New Regent bronze hand shower
- Mango de ducha New Regent cromo | New Regent chromed hand shower
- Mango de ducha C1 jet | C1 jet handshower
- Mango ducha extraible para FRV61205 | Pull-out FRV61205 sink tap sprayer
- Mango extraible fregadera | Pull-out sink tap sprayer
- Kit ducha sanitaria | Sanitary shower kit
- Mango Ducha para 65212 18 45 66 | Hand shower for 65212 18 45 66
- Mango ducha extraible E1 | Pull-out E1 sink tap sprayer



Florón
Scutcheon



Duchas
Shower

Recambios
Spare parts



Flexo
Flexible hose

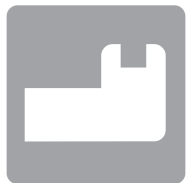

Soporte ducha
fijos
Fixed shower
holders

Ref.:

DXK3 45

DXL3 45

DXT5 45

R63112 26

R65112 18

R65112 19

100135 43 00

100135 60 00

100140 30

100141 45

100143 45

9908 0080

9908 0203

9908 0206

9908 0256

9908 0258

9908 0262

100067 45

100149 45

100152 45 00

100153 45

1647 43

1647 45

9908 0031

9908 0034

9908 0172

9908 0173

9908 0231

9908 0232

9908 0254

9908 0259

Descripción | Description

Mango de ducha K3 jets | K3 jets handshower

Mango de ducha L3 jets | L3 jets handshower

Mango de ducha T5 jets | T5 jets handshower

Rociador cuadrado 22 cm | Square shower head 22 cm

Rociador redondo 22 cm | Round shower head Ø 22 cm

Rociador D22 Oslo | Oslo D22 shower head

Flexo H 1/2" - H 1/2" bronce 1,7 m | F 1/2" - F 1/2" bronce 1.7 m flexible hose

Flexo H 1/2" - H 1/2" 1,7 m | F 1/2" - F 1/2" 1.7 m flexible hose

Flexo PVC H 1/2" - H 1/2" plata 1,7 m | F 1/2" - F 1/2" 1.7 m PVC silver flexible hose

Flexo teleducha H 1/2" - H 1/2" 1,2 m | F 1/2" - F 1/2" 1.2 m bidet shower flexible hose

Flexo flegadera 15 x 1 - H 1/2" 1,15 m | 15 x 1 - F 1/2" 1,15 m pull-out sink tap hose

Flexo para 65207 18 60 66 | Flexible hose for 65207 18 60 66

Flexo H 1/2" - H 1/2" 0,6 m cromado | F 1/2" - F 1/2" 0.6 m chromed flexible hose

Flexo H 1/2" - H 1/2" 1,5 m cromado | F 1/2" - F 1/2" 1.5 m chromed flexible hose

Flexo para 65212 18 45 66 | Flexible hose for 65212 18 45 66

Flexo para 65219 18 45 66 | Flexible hose for 65219 18 45 66

Flexo para FRV61206 | Flexible hose for FRV61206

Soporte ducha GE2 | GE2 shower holder

Soporte ducha Kenjo | Kenjo shower holder

Soporte ducha | Shower holder

Soporte ducha cilíndrico | Cylindrical shower holder

Soporte ducha Clásico bronce | Classic bronze shower holder

Soporte ducha Cásico | Classic shower holder

Soporte deslizante columna redonda | Round column shower holder

Soporte deslizante columna cuadrada | Square column shower holder

Soporte superior set redondo | Upper holder of round set

Soporte superior set cuadrado | Upper holder of square set

Soporte deslizante columna Oslo | Oslo column sliding shower holder

Soporte columna Oslo | Oslo column holder

Soporte ducha para 65212 18 45 66 | Shower holder for 65212 18 45 66

Soporte ducha para 65219 18 45 66 | Shower holder for 65219 18 45 66

Recambios
Spare parts



Soportes ducha
deslizantes
Sliding shower
holders



Caño
Spout



Aireador
Aerator

Ref.:

- 9908 0076**
- 9908 0077**
- 9908 0078**
- 9908 0079**

- 68901 45**
- 68902 45**
- 68903 45**
- 68904 45**
- 68911 45**
- 68912 45**
- 68913 45**
- 68914 45**
- 68915 45**
- 68916 45**
- 68917 45**
- 68922 45**
- 68924 45**
- 68925 45**
- 68926 45**
- 68927 45**
- 68928 45**
- 68929 45**
- 9908 0253**

- 100066 45**
- 100072 45**
- 100073 43**
- 100073 45**
- 100074 45**
- 100078 45**
- 100080 45**
- 100082 45**
- 100083 43**
- 100083 45**

Descripción | Description

Soporte deslizante ducha para 1636 45 | Sliding shower holder for 1636 45
 Soporte deslizante ducha para 1637 45 | Sliding shower holder for 1637 45
 Soporte deslizante ducha para 1638 45 | Sliding shower holder for 1638 45
 Soporte deslizante ducha para 1639 45 | Sliding shower holder for 1639 45

Caño alto tubo 18 cm | High pipe spout 18 cm
 Caño alto tubo 24 cm | High pipe spout 24 cm
 Caño tubo cisne | Vertical pipe spout
 Caño bajo tubo 24 cm | Low pipe spout 24 cm
 Caño mural tubo recto 16 cm | Wall-mounted pipe spout 16 cm
 Caño mural tubo recto 22 cm | Wall-mounted pipe spout 22 cm
 Caño mural tubo inclinado 20 cm | Wall-mounted sloping pipe spout 20 cm
 Caño mural tubo retro 20 cm | Wall-mounted retro pipe spout 20 cm
 Caño encimera recto tubo | Straight pipe spout
 Caño encimera cisne tubo | Swan neck pipe spout
 Caño encimera inclinado tubo | Sloping pipe spout
 Caño inferior elevado | High lower spout
 Caño mural tubo recto 16 cm | Wall mounted pipe spout 16 cm
 Caño mural tubo recto 22 cm | Wall mounted pipe spout 22 cm
 Caño mural rectangular 16 cm | Wall mounted rectangular pipe spout 16 cm
 Caño mural rectangular 22 cm | Wall mounted rectangular pipe spout 22 cm
 Caño mural tubo recto 16 cm D20 | D 20 Wall mounted pipe spout 16 cm
 Caño mural tubo recto 22 cm D20 | D 20 Wall mounted pipe spout 22 cm
 Caño para 65212 18 45 66 | Spout for 65212 18 45 66

Aireador M18 x 1 antical | M18 x 1 anti-lime aerator
 Aireador M24 x 1 antical antivandálico | M24 x 1 Antivandal anti-lime aerator
 Aireador H22x1 antical bronce retro | F22x1 bronze anti-lime retro aerator
 Aireador | Aireator
 Aireador M24 x 1 antical economizador Kelogic | M24 x 1 Antivandal anti-lime Kelogic aerator
 Aireador H22 x 1 antical economizador (blister 2 u.) | F22 x 1 Economizer anti-lime aerator (blister 2 u.)
 Aireador para 65203 18 45 66 | 65203 18 45 66 aerator
 Aireador 2 salidas antical | Double flow anti-lime aerator
 Aireador M28 x 1 antical bronce | M28 x 1 anti-lime bronze aerator
 Aireador M28 x 1 antical | M28 x 1 anti-lime aerator

Recambios
Spare parts



Cartucho
Cartridge



Montura
Headwork

Ref.:

100085 43
100085 45
100086 43
100086 45
100088 45
100089 45
9908 0026
9908 0043
9908 0044
9908 0267
9908 0268

100036

100037

100042

100044

100045

100046

100047

100048

100049

100051

100053

100054

100057

100064

9908 0051

67895 45

67896 45

67897 45

67898 45

67995 14

67999 45

68995 09

68995 11

Descripción | Description

Aireador M24 x 1 antical bronce | M24 x 1 anti-lime bronze aerator
Aireador M24 x 1 antical | M24 x 1 anti-lime aerator
Aireador M24 x 1 antical con rótula bronce | M24 x 1 bronze anti-lime aerator w/ kneecap
Aireador M24 x 1 antical con rótula | M24 x 1 anti-lime aerator w/ kneecap
Atomizador H22 x 1 antical | F22 x 1 anti-lime aerator
Aireador H18 x 1 antical | F18 x 1 aerator anti-lime
Aireador para caño rectangular | Rectangular spout aerator
Aireador para 65203 18 60 66 | 65203 18 60 66 aerator
Aireador para 65208 18 60 66 | 65208 18 60 66 aerator
Aireador antivandálico orientable | Antivandal orientable aerator
Aireador antivandálico | Antivandal aerator

Cartucho cerámico D35 salida libre 2 posiciones | 2 Positions free flow D35 ceramic cartridge

Cartucho termóstático | Thermostatic mixer cartridge

Cartucho cerámico D25 convencional 1 agua | 1 water conventional D25 ceramic cartridge

Cartucho cerámico D25 convencional | Conventional D25 ceramic cartridge

Cartucho cerámico D40 convencional 2 posiciones | 2 positions conventional D40 ceramic cartridge

Cartucho cerámico progresivo | Progressive ceramic cartridge

Cartucho termóstático D24 | D24 thermostatic cartridge

Cartucho cerámico D40 salida libre 2 posiciones | 2 positions free flow D40 ceramic cartridge

Cartucho cerámico D40 convencional | Conventional D40 ceramic cartridge

Cartucho cerámico D40 salida libre | Free flow D40 ceramic cartridge

Cartucho cerámico D35 convencional | Conventional D35 ceramic cartridge

Cartucho cerámico D35 salida libre | Free flow D35 ceramic cartridge

Cartucho cerámico D25 convencional | Conventional D25 ceramic cartridge

Cartucho cerámico D40 junta superior salida libre 2 posiciones | 2 positions free flow D40 ceramic cartridge upper gasket

Cartucho termóstático empotrada | Built-in tap thermostatic mixer cartridge

Montura cerámica larga | Ceramic long headwork

Montura convencional larga | Conventional long headwork

Montura cerámica apertura derecha | Clockwise opening ceramic headwork

Montura cerámica larga apertura derecha | Clockwise opening long ceramic headwork

Montura cerámica para termóstática | Thermostatic tap ceramic headwork

Montura cerámica agua filtrada | Ceramic headwork filtered water

Montura cerámica | Ceramic headwork

Montura convencional | Conventional headwork

Recambios
Spare parts



Inversor
Diverter



Conexión
flexible
Connection set



Conjunto
sujeción
Fixation set

Ref.:

9908 0238

100069

100117 45

100157 45

100158 45

100159 45

100160 45

100161 45

100162 45

100164 45

100173 45

100174 45

9908 0024

9908 0025

9908 0032

9908 0035

9908 0052

9908 0054

9908 0233

9908 0237

9908 0252

100100

100103

100104

100105

100111

100118

100090

100091

100092

100095

100097

100098

9908 0042

9908 0047

9908 0048

Descripción | Description

Montura cerámica para termostática Oslo | Oslo thermostatic ceramic headwork

Inversor cerámico columna termostática | Thermostatic column ceramic diverter

Inversor compacto Oslo | Oslo compact diverter

Inversor Kelogic | Kelogic diverter

Inversor termostático Kenjo | Kenjo thermostatic diverter

Inversor cerámico termostática | Thermostatic ceramic diverter

Inversor ABS cromo | ABS chromed diverter

Inversor botón | Button diverter

Inversor largo baño empotrado | Built-in large push-button diverter

Inversor compacto Tau | Tau compact diverter

Inversor cerámico largo baño empotrado | Built-in large push-button diverter

Inversor convencional para batería bidet | Bidet set conventional diverter

Inversor cerámico 2 vías | 2 way ceramic diverter

Inversor cerámico 3 vías | 3 way ceramic diverter

Inversor columna redonda | Round column diverter

Inversor columna cuadrada | Square column diverter

Inversor cerámico termostática 2 vías | 2 way thermostatic tap ceramic diverter

Inversor cerámico termostática 3 vías | 3 way thermostatic tap ceramic diverter

Inversor cerámico columna Oslo | Oslo column ceramic diverter

Inversor columna Oslo | Oslo column diverter

Inversor para 65212 18 45 66 | Diverter for 65212 18 45 66

Juego de conexiones 10 x 1 - H 3/8" a 55 cm | 10 x 1 - F 3/8" 55 cm connection set

Juego de conexiones 10/100 x H 3/8" a 35 cm | Connctions set F 3/8" x 10/100 to 35 cm

Conexión PVC 10x1 - H 3/8" a 60 cm | 10x1 - F 3/8" 60 cm PVC connection

Juego de conexiones 10 x 1 - H 3/8" a 40 cm | 10 x 1 - F 3/8" 40 cm connection set

Juego de conexiones 10x1 - 15x1 a 15 cm | 10x1 - 15x1 15 cm connection set

Conjunto sujeción | Fixation set

Conjunto sujeción 2 tornillos | 2 screws fixation set

Conjunto sujeción Klip | Klip Fixation set

Conjunto sujeción Kenjo | Kenjo fixation set

Conjunto sujeción fregadera extraíble | Pull-out sink tap fixation set

Conjunto sujeción 1/2" | Fixation set 1/2"

Conjunto sujeción M32 | M32 fixation set

Conjunto sujeción lavabo Oslo | Oslo basin fixation set

Conjunto sujeción lavabo medio alto Oslo | Oslo medium high basin fixation set

Recambios
Spare parts



Conjunto excéntrica
Eccentric set



Cuerpo
body



Placa
Tap plates

Ref.:

- 9908 0049**
- 9908 0050**
- 9908 0064**
- 9908 0264**
- 9908 0265**
- 9908 0266**
- 9908 0271**

- 100114 45**
- 100125 43**
- 100125 45**
- 100126 45**
- 100127 45**
- 100128 45**

- 51744 45**
- 568113 45**
- 568115 45**
- 568116 45**
- 568120 45**
- 568131 45**
- 568142 45**
- 568170 45**
- 9908 0170**
- 9908 0171**
- 5CT65111 45**
- 5CM65111 45**

- 9908 0053**
- 9908 0055**
- PK115**
- PK116**
- PK131**
- PL115**
- PL116**
- PL131**
- PO113**
- PO115**
- PO117**

Descripción | Description

- Conjunto sujeción lavabo alto Oslo | Oslo high basin fixation set
- Conjunto sujeción bidé Oslo | Oslo bidet fixation set
- Conjunto Sujeción | Fixation set
- Conjunto sujeción 61200 | 61200 fixation set
- Conjunto sujeción 115 M8 | 115 M8 fixation set
- Conjunto sujeción FRK | FRK fixation set
- Conjunto Sujeción para 65700 18 45 66 | Fixation set for 65700 18 45 66

- Conjunto florón y excéntricas oval | Oval scutcheon and eccentric set
- Conjunto florón y excéntricas bronce | Bronze scutcheon and eccentric set
- Conjunto florón y excéntricas | Scutcheon and eccentric set
- Conjunto florón y excéntricas redondo D60 | Round D60 scutcheon and eccentric set
- Conjunto florón y excéntricas redondo D65 | Round D65 scutcheon and eccentric set
- Conjunto florón y excéntricas cuadrado | Square scutcheon and eccentric set

- Cuerpo inversor set Oslo | Oslo set diverter body
- Batería de baño con inversor | Widespread bath mixer with diverter
- Grupo ducha empotrado 8" | Built-in 8" shower mixer
- Grupo baño empotrado 8" con inversor | Built-in 8" bath mixer with diverter
- Batería de lavabo | Widespread wash-basin mixer
- Grupo de lavabo empotrado | Built-in wash-basin mixer
- Batería de bidé con transmisión | Widespread bidet mixer with transmission
- Llave de paso 1/2" | Stopcock 1/2"
- Inversor set redondo con base | Round set diverter with base
- Inversor set cuadrado con base | Square set diverter with base
- Cuerpo termostático columna Oslo | Oslo column thermostatic mixer body
- Cuerpo monomando columna Oslo | Oslo column single lever mixer body

- Placa termostática empotrada 3 vías | Built-in 2 way thermostatic mixer plate
- Placa termostática empotrada 2 vías | Built-in 3 way thermostatic mixer plate
- Placa ducha empotrada | Built-in shower mixer plate
- Placa baño/ducha empotrado | Built-in bath/shower mixer plate
- Placa lavabo caño cuadrado | Square spout basin plate
- Placa ducha empotrada | Built-in shower mixer plate
- Placa baño/ducha empotrado | Built-in bath/shower mixer plate
- Placa lavabo ovalada D35 | D35 oval basin mixer plate
- Placa inversor ovalada | Diverter oval plate
- Placa ovalada ducha empotrada | Built-in shower mixer plate
- Placa ovalada empotrada 2 vías | Built-in 2 way oval plate

Recambios
Spare parts



Inversor
Diverter

Ref.:

PO118
PO131
PR113
PS115
PS116
PT113
PT115
PT116
PT117
PT118
PT131

100019
9908 0269
9908 0270
9908 0271
9908 0030
9908 0033
9908 0063
9908 0074
9908 0075
9908 0152
9908 0153
9908 0154
9908 0230
9908 0257
9908 0261
J15
J16
J18
J19
J20
J61
J65
J67
J68

Descripción | Description

Placa ovalada empotrada 3 vías | Built-in 3 way oval plate
Placa lavabo ovalada | Oval basin plate
Placa inversor redonda | Diverter round plate
Placa ducha empotrada | Built-in shower mixer plate
Placa baño/ducha empotrado | Built-in bath/shower mixer plate
Placa inversor cuadrada | Diverter square plate
Placa ducha empotrada | Built-in shower tap plate
Placa baño/ducha empotrado | Built-in bath/shower mixer plate
Placa rectangular empotrada 2 vías | Built-in 2 way rectangular plate
Placa rectangular inversor empotrada 3 vías | Built-in 3 way rectangularplate
Placa lavabo rectangular | Rectangular basin mixer plate

Set de juntas inversor monomando bidé | Gasket set single lever bidet diverter
Set de juntas para 65215 40 60 66 | Gasket set for 65215 40 60 66
Set de juntas para 65219 40 60 66 | Gasket set for 65219 40 60 66
Conjunto Sujeción para 65700 18 45 66 | Fixation set for 65700 18 45 66
Set juntas columna redonda | Round column gasket set
Set juntas columna cuadrada | Square column gasket set
Set juntas montura convencional | Join set conventional headwork
Set de juntas para 61900 28 45 66 | Gasket set for 61900 28 45 66
Set de juntas para 65900 18 45 66 | Gasket set for 65900 18 45 66
Set de juntas serie A | A series gasket set
Set de juntas serie B | B series gasket set
Set de juntas serie C | C series gasket set
Set juntas columna Oslo | Oslo column gasket set
Set de juntas para 65212 18 45 66 | Gasket set for 65212 18 45 66
Set de juntas para 65219 18 45 66 | Gasket set for 65219 18 45 66
Set de juntas inversor monomando bidé | Single lever bidet mixer diverter gasket set
Set de juntas R16 | R16 gasket set
Set de juntas para 65203 18 60 66 | Gasket set for 65203 18 60 66
Set de juntas para 65208 18 60 66 | Gasket set for 65208 18 60 66
Set de juntas para 65211 18 60 66 | Gasket set for 65211 18 60 67
Set de juntas 61200 | 61200 gasket set
Set de juntas R21 | R21 gasket set
Set de juntas 65702 18 45 66 | 65702 18 45 66 gasket set
Set de juntas caño tubo | Pipe spout gasket set

Recambios
Spare parts



Muelles
Springs



Set retenciones
Check valve sets



Tapones
Caps

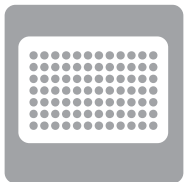

Filtros
Filter

Ref.:

9908 0155

9908 0156

9908 0157

9908 0011

9908 0012

9908 0236

9908 0162

9908 0163

9908 0164

9908 0165

9908 0166

9908 0167

9908 0168

FT92

Descripción | Description

Muelle click L25 | L25 click spring

Muelle click L35 | L35 click spring

Muelle click L38 | L38 click spring

Retenciones termostáticas murales | Wall thermostatic mixer check valve

Retenciones termostáticas empotradas | Built-in tap thermostatic mixer check valve

Set de retenciones para termostáticas Oslo | Oslo thermostatic mixer check valve set

Tapón V-Click "Luxe" | Cap V-Click "Luxe"

Tapón V-Click "Luxe Bronce" | Cap V-Click "Luxe Bronze"

Tapón V-Click Kenjo | Cap V-Click Kenjo

Tapón V-click 1 1/4" | Cap V-click 1 1/4"

Tapón V-click 1 1/2" | Cap V-click 1 1/2"

Tapón V-click 1 1/4" | Cap V-click 1 1/4"

Tapón V-click 1 1/4" | Cap V-click 1 1/4"

Filtro declorador | Declorator filter



Información técnica Technical information

Consulte la ficha técnica de nuestros productos

Para encontrar toda la información técnica de cualquier producto, localice la referencia del artículo.

Consult data sheet of our products

Use the item reference to find all of the technical information on any of our products.

Simbolos | Symbols

	Maneta Handle		Volantes Handles		Florón Scutcheon		Duchas Shower
	Flexo Flexible hose		Soporte ducha fijos Fixed shower holders		Soportes ducha deslizantes Sliding shower holders		Caño Spout
	Aireador Aerator		Cartucho Cartridge		Montura Headwork		Inversor Diverter
	Conexión flexible Connection set		Conjunto sujeción Fixation set		Conjunto excéntrica Eccentric set		Cuerpo Body
	Placa Tap plates		Set juntas Gasket set		Muelles Springs		Set retenciones Check valve sets
	Tapones Caps		Filtros Filter				

serie Kode | Acabado cromado. Cartucho 40 | Chromed finish. Cartridge 40

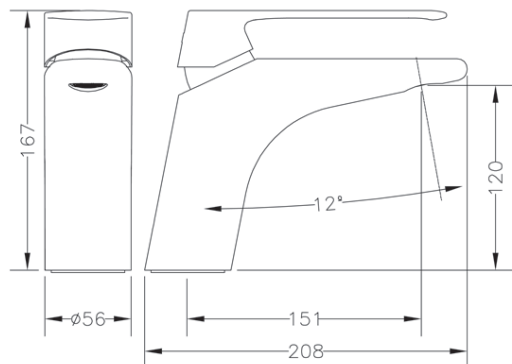

Ref.: 62130 08 45 66
Monomando de lavabo
Single lever wash-basin mixer

Box: 1 | Carton: 8 | Pallet: 192



100001 08 45 | 100072 45 | 100045 | 100105 | 100092

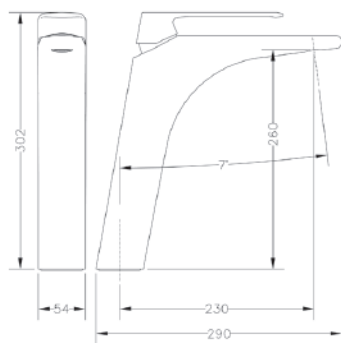

Ref.: 62136 08 45 66
Monomando de lavabo alto
High single lever wash-basin mixer

Box: 1 | Carton: 4 | Pallet: 96



100001 08 45 | 100072 45 | 100064 | 100105 | 9908 0042

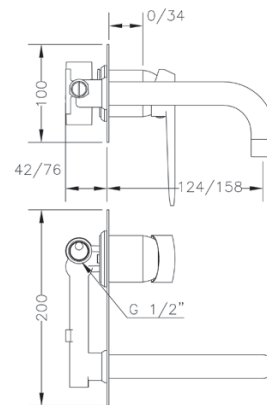

Ref.: 62131 31 45 66
Monomando de lavabo empotrado caño 16 cm
Built-in wash-basin mixer 16 cm spout

Box: 1 | Carton: 6 | Pallet: 144



100001 31 45 | 68924 45 | 100088 45 | 100049 | PO131

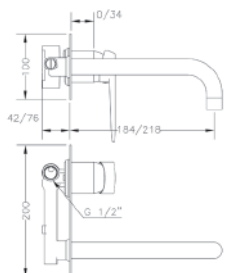

Ref.: 62132 31 45 66
Monomando de lavabo empotrado caño 22 cm
Built-in wash-basin mixer 22 cm spout

Box: 1 | Carton: 6 | Pallet: 144



100001 31 45 | 68925 45 | 100088 45 | 100049 | PO131

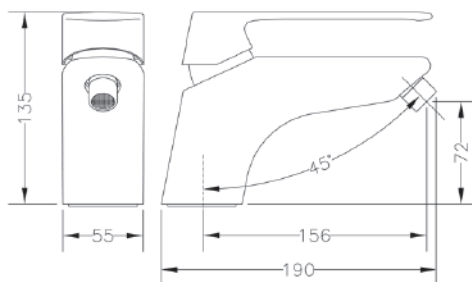

Ref.: 62140 08 45 66
Monomando de bidé
Single lever bidet mixer

Box: 1 | Carton: 8 | Pallet: 192



100001 08 45 | 100086 45 | 100045 | 100105 | 100092

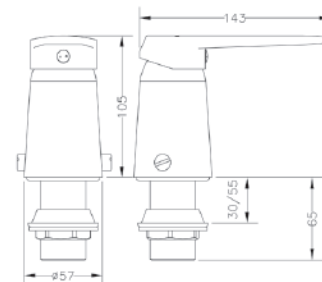

Ref.: 62142 31 45 66
Monomando de bidé con transmisión
Single lever bidet mixer with diverter

Box: 1



100001 31 45 | 100051 | 100111 | 100104 | J15

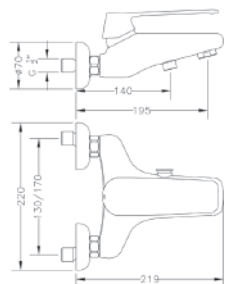

Ref.: 62100 08 45 67
Monomando de baño sin kit
Single lever bath mixer without kit

Box: 1 | Carton: 6 | Pallet: 144



100001 08 45 | 100083 45 | 100045 | 100161 45 | 100114 45

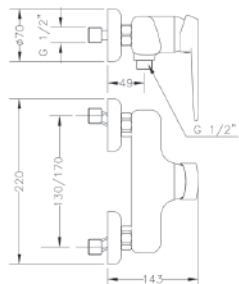

Ref.: 62110 31 45 67
Monomando de ducha sin kit
Single lever shower mixer without kit

Box: 1 | Carton: 6 | Pallet: 144



100001 31 45 | 100045 | 100114 45

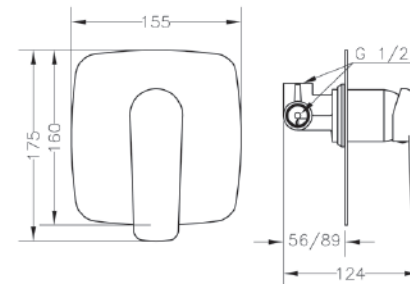

Ref.: 62115 31 45 66
Monomando de ducha empotrado
Built-in single lever shower mixer

Box: 1 | Carton: 8 | Pallet: 192



100001 31 45 | 100049 | PO115

serie Kode | Acabado cromado. Cartucho 40 | Chromed finish. Cartridge 40

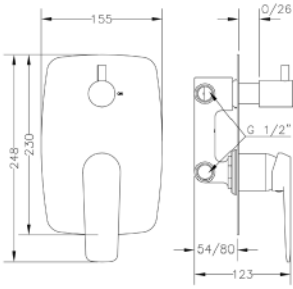

Ref.: 62117 31 45 66
 Monomando empotrado con inversor cerámico 2 vías
 Built-in single lever mixer with 2 way ceramic diverter

Box: 1 | Carton: 6 | Pallet: 108



100001 31 45 | 68998 30 45 | 100049 | 9908 0024 | PO117

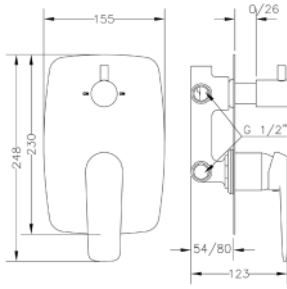

Ref.: 62118 31 45 66
 Monomando empotrado con inversor cerámico 3 vías
 Built-in single lever mixer with 3 way ceramic diverter

Box: 1 | Carton: 6 | Pallet: 144



100001 31 45 | 68998 30 45 | 100049 | 9908 0025 | PO118

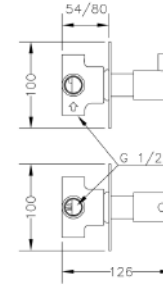

Ref.: 62114 30 45 66
 Inversor cerámico 3 vías empotrado con placa ovalada
 Built-in 3 way ceramic diverter with oval plate
Box: 1 | Carton: 8 | Pallet: 384



68998 30 45 | 9908 0025 | PO113

serie Oslo | Acabado cromado. Cartucho 35 | Chromed finish. Cartridge 35

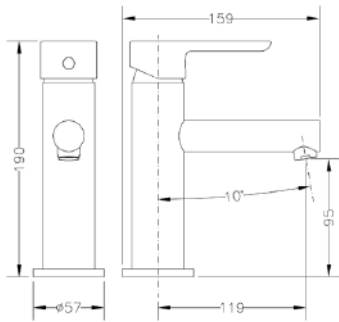

Ref.: 65130 19 45 66
 Monomando de lavabo
 Single lever wash-basin mixer

Box: 1 | Carton: 12 | Pallet: 192



100001 19 45 | 100066 45 | 100036 | 100105 | 9908 0047

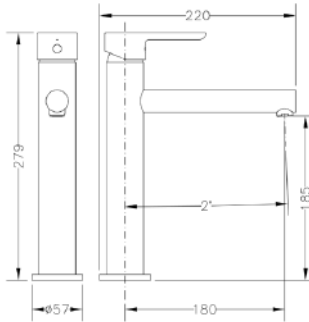

Ref.: 65134 19 45 66
 Monomando de lavabo medio alto
 Medium height single lever wash-basin mixer

Box: 1 | Carton: 10 | Pallet: 80



100001 19 45 | 100066 45 | 100036 | 100100 | 9908 0048

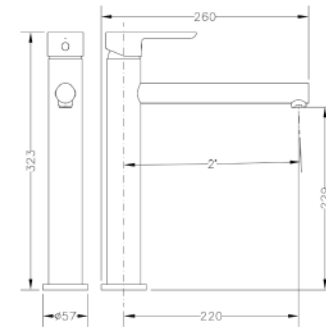

Ref.: 65136 19 45 66
 Monomando de lavabo alto
 High single lever wash-basin mixer

Box: 1 | Carton: 10 | Pallet: 80



100001 19 45 | 100066 45 | 100036 | 100100 | 9908 0049

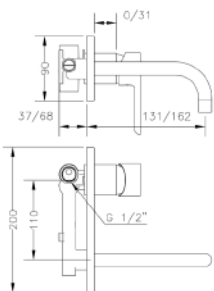

Ref.: 65131 19 45 66
 Monomando de lavabo empotrado caño 16 cm
 Built-in wash-basin mixer 16 cm spout

Box: 1 | Carton: 6 | Pallet: 144



100001 19 45 | 68928 45 | 100089 45 | 100053 | PL131

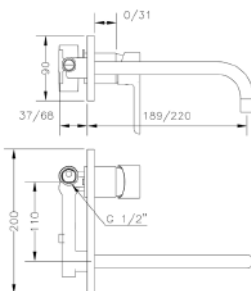

Ref.: 65132 19 45 66
 Monomando de lavabo empotrado caño 22 cm
 Built-in wash-basin mixer 22 cm spout

Box: 1 | Carton: 6 | Pallet: 144



100001 19 45 | 68929 45 | 100089 45 | 100053 | PL131

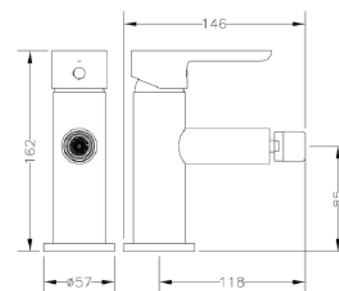

Ref.: 65140 19 45 66
 Monomando de bidé
 Single lever bidet mixer

Box: 1 | Carton: 12 | Pallet: 192



100001 19 45 | 100086 45 | 100054 | 100105 | 9908 0050

serie Oslo | Acabado cromado. Cartucho 35 | Chromed finish. Cartridge 35

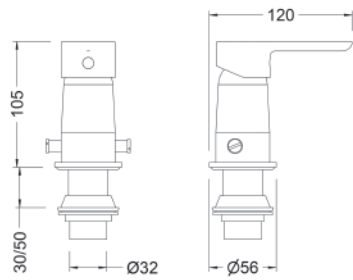

Ref.: 65142 19 45 66
 Monomando de bidé con transmisión
 Single lever bidet mixer with diverter

Box: 1 | Carton: 12 | Pallet: 288



100001 19 45 | 100053 | 100019 | 100111 | 100104 | J15

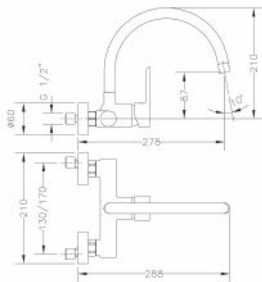

Ref.: 65192 19 45 66
 Monomando de fregadera mural 15 cm
 Wall single lever sink mixer 15 cm

Box: 1 | Carton: 6 | Pallet: 54



100001V 19 45 | 100089 45 | 100054 | 100126 45 | J16

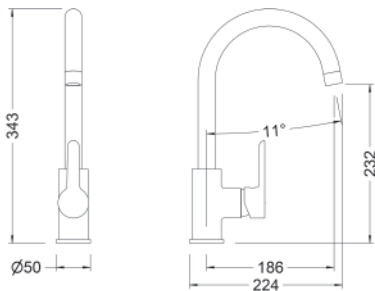

Ref.: 65203 19 45 66
 Monomando de fregadera apertura en frío
 Single lever sink mixer cold start

Box: 1 | Carton: 8 | Pallet: 96



100001R 19 45 | 100088 45 | 100053 | 100105 | 100090



J16

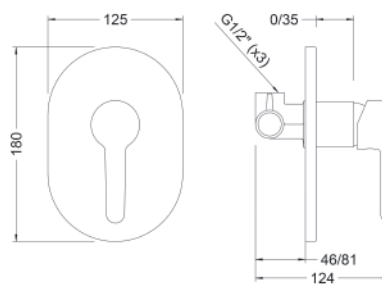

Ref.: 65115 19 45 66
 Monomando de ducha empotrado
 Built-in single lever shower mixer

Box: 1 | Carton: 12 | Pallet: 324



100001 19 45 | 100053 | PL115

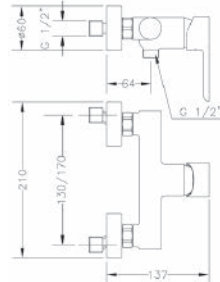

Ref.: 65110 19 45 66
 Monomando de ducha con kit
 Single lever shower mixer with kit

Box: 1 | Carton: 8 | Pallet: 96



100001 19 45 | 100197 45 00 | 100135 60 00 | 100153 45



100054 | 100126 45

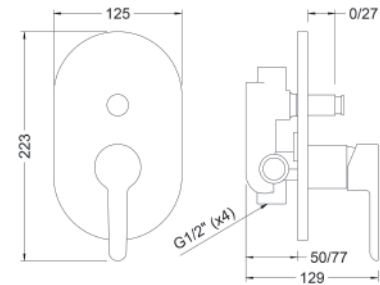

Ref.: 65116 19 45 66
 Monomando de baño empotrado con inversor
 Built-in single lever bath mixer with diverter

Box: 1 | Carton: 12 | Pallet: 324



100001 19 45 | 100053 | 100162 45 | PL116

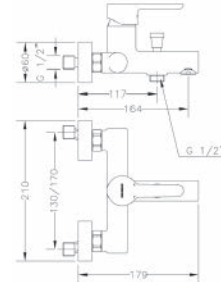

Ref.: 65100 19 45 66
 Monomando de baño con kit
 Single lever bath mixer with kit

Box: 1 | Carton: 8 | Pallet: 96



100001 19 45 | 100197 45 00 | 100135 60 00 | 100153 45



100085 45 | 100054 | 100117 45 | 100126 45

serie Oslo | Acabado cromado. Cartucho 35 | Chromed finish. Cartridge 35

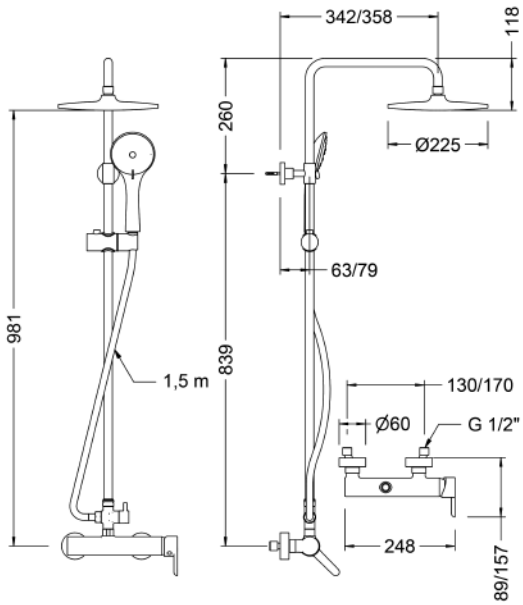

Ref.: CM65110 19
 Columna monomando fija con kit
 Single lever fixed column with kit

Box: 1 | Carton: 4 | Pallet: 24

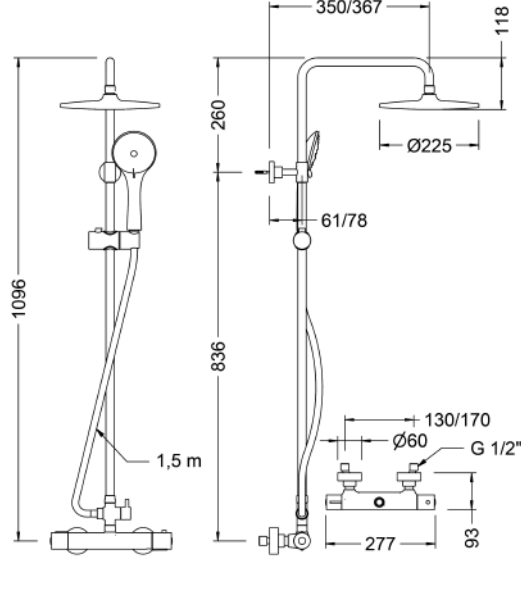

Ref.: CT67110 19
 Columna termostática fija con kit
 Thermostatic fixed column with kit

Box: 1 | Carton: 4 | Pallet: 24

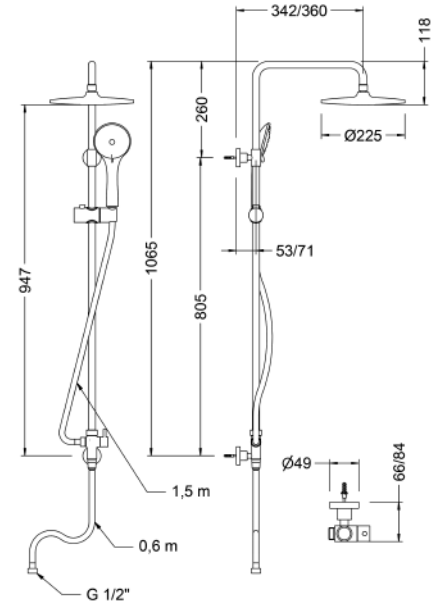
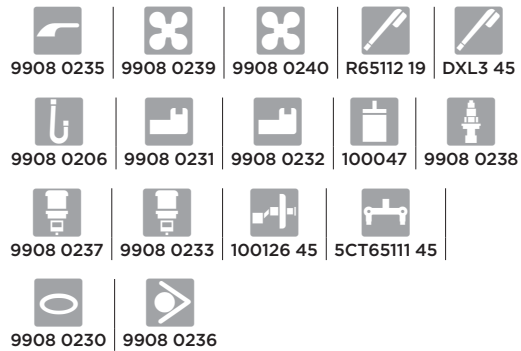

Ref.: 1744 45
 Set columna fija con kit
 Fixed column set with kit

Box: 1 | Carton: 4 | Pallet: 24



serie Klip | Acabado cromado. Cartucho 40 | Chromed finish. Cartridge 40

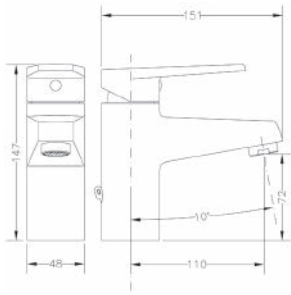

Ref.: 64130 16 45 66
Monomando de lavabo
Single lever wash-basin mixer

Box: 1 | Carton: 20 | Pallet: 360

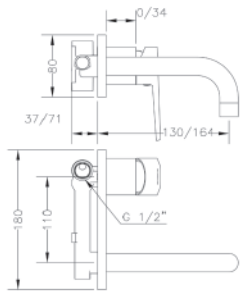

Ref.: 64131 16 45 66
Monomando de lavabo empotrado caño 16 cm
Built-in wash-basin mixer 16 cm spout

Box: 1 | Carton: 6 | Pallet: 144

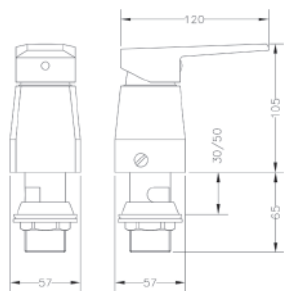

Ref.: 64142 16 45 66
Monomando de bidé con transmisión
Single lever bidet mixer with diverter

Box: 1 | Carton: 12 | Pallet: 216

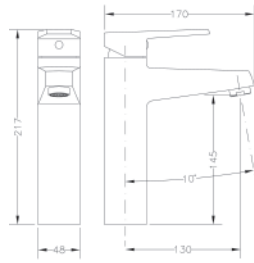

Ref.: 64134 16 45 66
Monomando de lavabo medio alto
Medium height single lever wash-basin mixer

Box: 1 | Carton: 10 | Pallet: 180

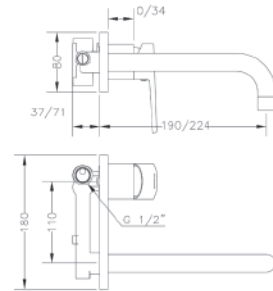

Ref.: 64132 16 45 66
Monomando de lavabo empotrado caño 22 cm
Built-in wash-basin mixer 22 cm spout

Box: 1 | Carton: 6 | Pallet: 144

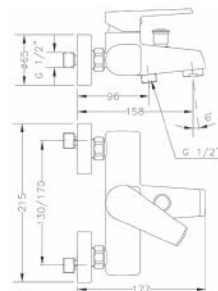

Ref.: 64100 16 45 66
Monomando de baño con kit
Single lever bath mixer with kit

Box: 1 | Carton: 8 | Pallet: 96

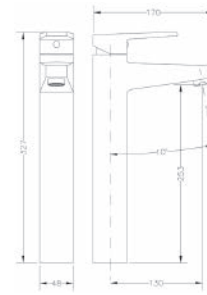

Ref.: 64136 16 45 66
Monomando de lavabo alto
High single lever wash-basin mixer

Box: 1 | Carton: 6 | Pallet: 108

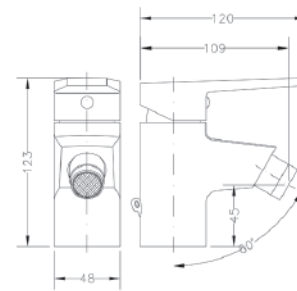

Ref.: 64140 16 45 66
Monomando de bidé
Single lever bidet mixer

Box: 1 | Carton: 8 | Pallet: 480

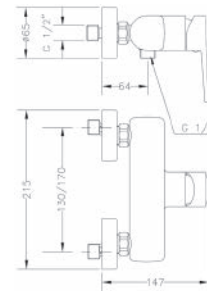

Ref.: 64110 16 45 66
Monomando de ducha con kit
Single lever shower mixer with kit

Box: 1 | Carton: 8 | Pallet: 96



serie Klip | Acabado cromado. Cartucho 40 | Chromed finish. Cartridge 40

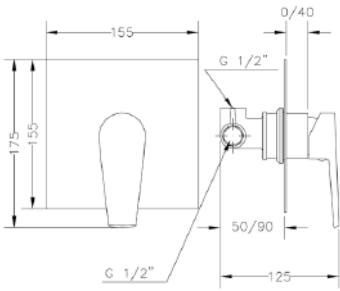

Ref.: 64115 16 45 66
 Monomando de ducha empotrado
 Built-in single lever shower mixer

Box: 1 | Carton: 12 | Pallet: 216

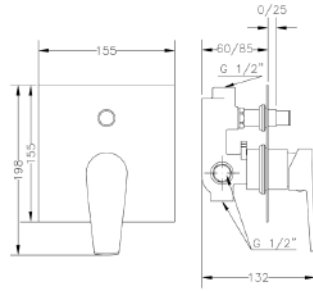

Ref.: 64116 16 45 66
 Monomando de baño empotrado con inversor
 Built-in single lever bath mixer with diverter

Box: 1 | Carton: 12 | Pallet: 216

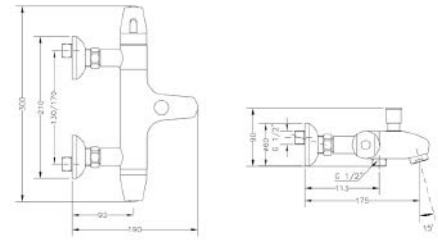

Ref.: 67103 14 45 67
 Termostática baño
 Thermostatic bath mixer

Box: 1 | Carton: 6 | Pallet: 108

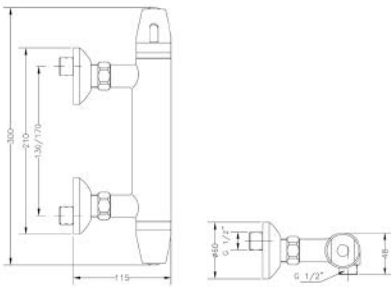

Ref.: 67104 14 45 67
 Termostática ducha
 Thermostatic shower mixer

Box: 1 | Carton: 12 | Pallet: 288

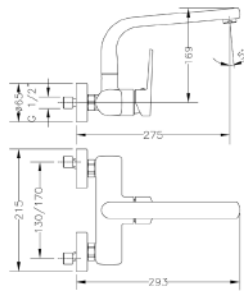

Ref.: 64192 16 45 66
 Monomando de fregadera mural
 Wall single lever sink mixer

Box: 1 | Carton: 6 | Pallet: 72

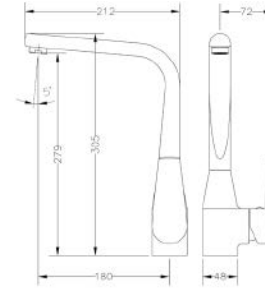

Ref.: 64201 16 45 66
 Monomando de fregadera
 Single lever sink mixer

Box: 1 | Carton: 8 | Pallet: 144



J65

serie Klip | Acabado cromado. Cartucho 40 | Chromed finish. Cartridge 40

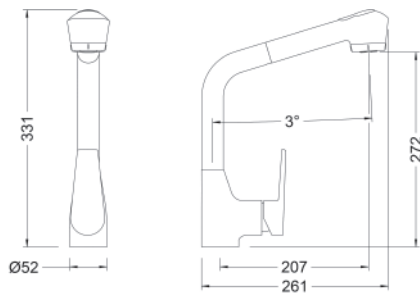

Ref.: 64206 16 45 66

Monomando de fregadera ducha extraíble
Single lever sink mixer with pull-out spray

Box: 1 | Carton: 6 | Pallet: 108



100001V 16 45 | 100252 45 | 100143 45 | 100085 | 100049



100105 | 100118 | 100097

serie Klip 2 | Acabado cromado. Cartucho 40 | Chromed finish. Cartridge 40

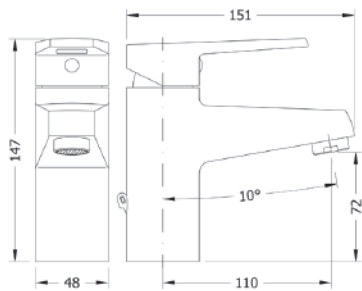

Ref.: 64130 14 45 66

Monomando de lavabo
Single mixer

Box: 1 | Carton: 20 | Pallet: 360



100001 14 45 | 100085 45 | 100045 | 100105 | 100092

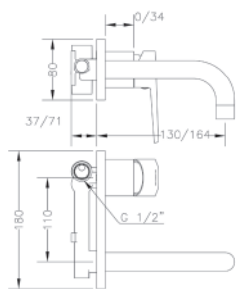

Ref.: 64131 14 45 66

Monomando de lavabo empotrado caño 16 cm
Built-in wash-basin mixer 16 cm spout

Box: 1 | Carton: 6 | Pallet: 108



100001 14 45 | 68924 45 | 100088 45 | 100049 | PT131

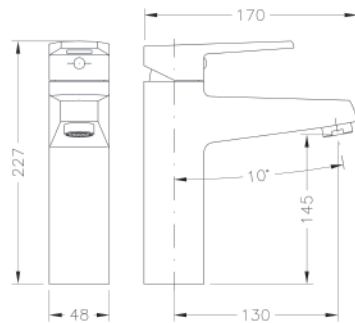

Ref.: 64134 14 45 66

Monomando de lavabo medio alto
Medium height single lever wash-basin mixer

Box: 1 | Carton: 10 | Pallet: 180



100001 14 45 | 100085 45 | 100048 | 100103 | 100092

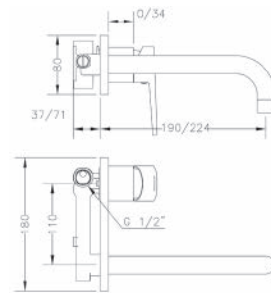

Ref.: 64132 14 45 66

Monomando de lavabo empotrado caño 22 cm
Built-in wash-basin mixer 22 cm spout

Box: 1 | Carton: 6 | Pallet: 108



100001 14 45 | 68925 45 | 100088 45 | 100049 | PT131

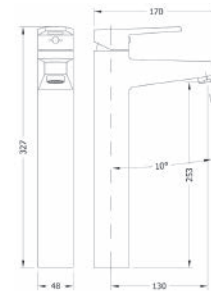

Ref.: 64136 14 45 66

Monomando de lavabo alto
High single lever wash-basin mixer

Box: 1 | Carton: 6 | Pallet: 108



100001 14 45 | 100085 45 | 100048 | 100103 | 100092

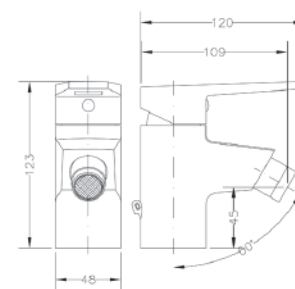

Ref.: 64140 14 45 66

Monomando de bidé
Single lever bidet mixer

Box: 1 | Carton: 8 | Pallet: 480



100001 14 45 | 100086 45 | 100049 | 100105 | 100092

serie Klip 2 | Acabado cromado. Cartucho 40 | Chromed finish. Cartridge 40

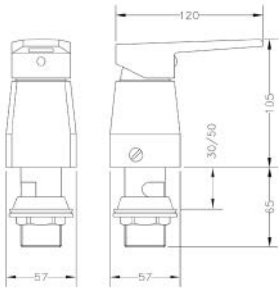

Ref.: 64142 14 45 66
Monomando de bidé con transmisión
Single lever bidet mixer with diverter

Box: 1 | Carton: 12 | Pallet: 216

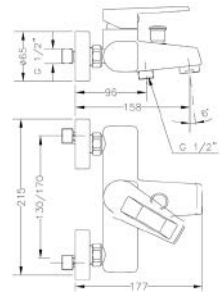

Ref.: 64100 14 45 66
Monomando de baño con kit
Single lever bath mixer with kit

Box: 1 | Carton: 8 | Pallet: 96

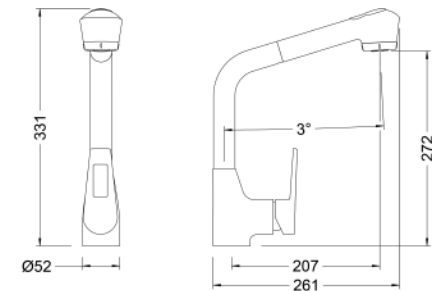

Ref.: 64206 14 45 66
Monomando de fregadera ducha extraíble
Single lever sink mixer with pull-out spray

Box: 1 | Carton: 6 | Pallet: 108

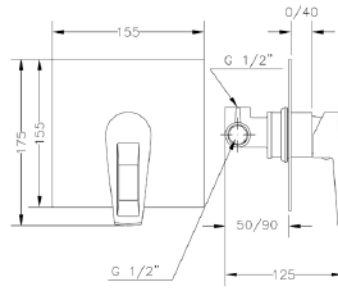

Ref.: 64115 14 45 66
Monomando de ducha empotrado
Built-in single lever shower mixer

Box: 1 | Carton: 12 | Pallet: 216

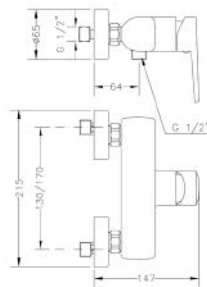

Ref.: 64110 14 45 66
Monomando de ducha con kit
Single lever shower mixer with kit

Box: 1 | Carton: 8 | Pallet: 96

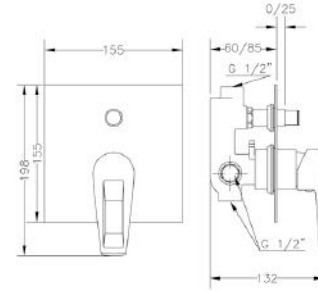
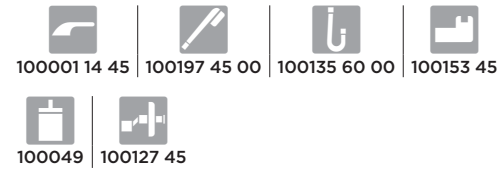

Ref.: 64116 14 45 66
Monomando de baño empotrado con inversor
Built-in single lever bath mixer with diverter

Box: 1 | Carton: 12 | Pallet: 216

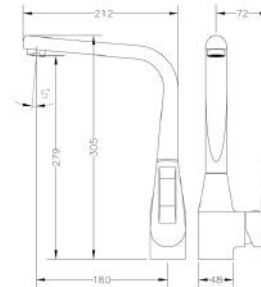

Ref.: 64201 14 45 66
Monomando de fregadera
Single lever sink mixer

Box: 1 | Carton: 8 | Pallet: 144

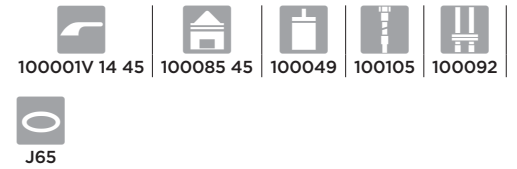

serie Kelogic | Acabado cromado. Cartucho 40 | Chromed finish. Cartridge 40

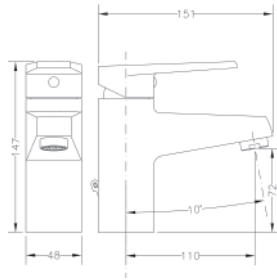

Ref.: 64130 04 45 66

Monomando de lavabo apertura en frío
Single lever wash-basin mixer cold start

Box: 1 | Carton: 20 | Pallet: 360

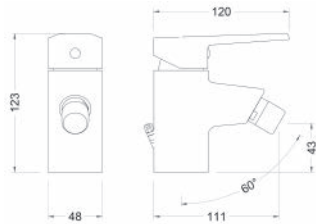

Ref.: 64140 04 45 66

Monomando bidé apertura en frío
Single lever bidet mixer cold start

Box: 1 | Carton: 8 | Pallet: 480

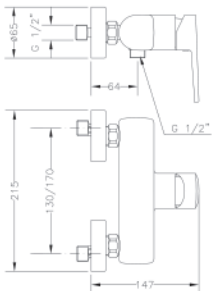

Ref.: 64110 04 45 66

Monomando de ducha con kit
Single lever shower mixer with kit

Box: 1 | Carton: 8 | Pallet: 96

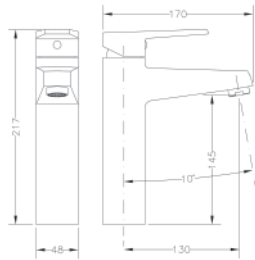

Ref.: 64134 04 45 66

Monomando lavabo medio alto apertura en frío
Medium height single lever wash-basin mixer cold start

Box: 1 | Carton: 10 | Pallet: 180

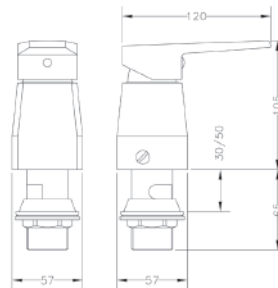

Ref.: 64142 04 45 66

Monomando de bidé con transmisión
Single lever bidet mixer with diverter

Box: 1 | Carton: 12 | Pallet: 216

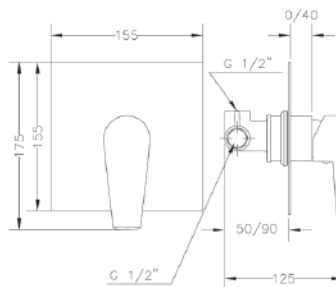

Ref.: 64115 16 45 66

Monomando de ducha empotrado
Built-in single lever shower mixer

Box: 1 | Carton: 12 | Pallet: 216

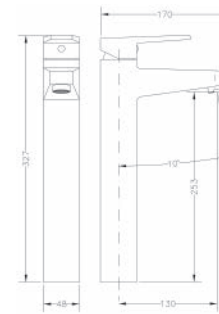

Ref.: 64136 04 45 66

Monomando lavabo alto apertura en frío
High single lever wash-basin mixer cold start

Box: 1 | Carton: 6 | Pallet: 108

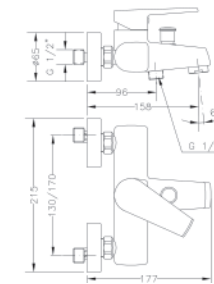

Ref.: 64100 04 45 66

Monomando de baño con kit
Single lever bath mixer with kit

Box: 1 | Carton: 8 | Pallet: 128

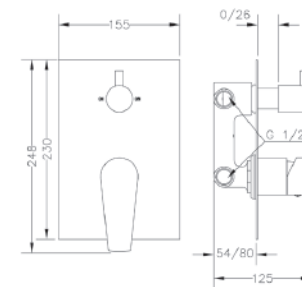

Ref.: 64117 04 45 66

Monomando empotrado con inversor cerámico 2 vías
Built-in single lever mixer with 2-way ceramic diverter

Box: 1 | Carton: 6 | Pallet: 108



serie Kelogic | Acabado cromado. Cartucho 40 | Chromed finish. Cartridge 40

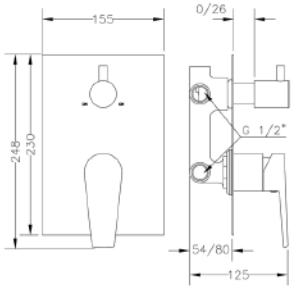

Ref.: 64118 04 45 66
 Monomando empotrado con inversor cerámico 3 vías
 Built-in single handle mixer with 3-way ceramic diverter

Box: 1 | Carton: 6 | Pallet: 108

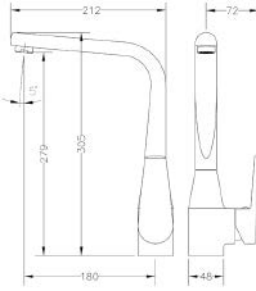

Ref.: 64201 04 45 66
 Monomando de fregadera apertura frío
 Single lever sink mixer cold start

Box: 1 | Carton: 6 | Pallet: 108



serie Tau | Acabado cromado. Cartucho 40 | Chromed finish. Cartridge 40

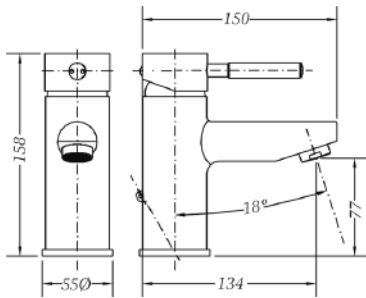

Ref.: 65135 18 45 66
 Monomando de lavabo
 Single lever wash-basin tap

Box: 1 | Carton: 12 | Pallet: 216

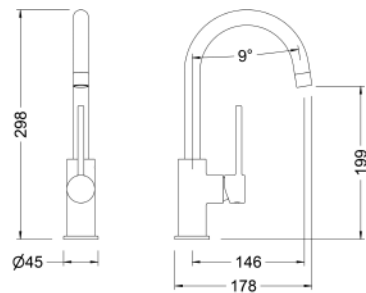

Ref.: 65138 18 45 66
 Monomando de lavabo apertura en frío
 Single lever wash-basin tap cold start

Box: 1 | Carton: 10 | Pallet: 180

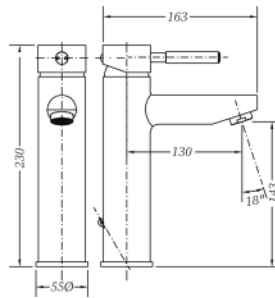

Ref.: 65134 18 45 66
 Monomando de lavabo medio alto
 Medium height single lever wash-basin mixer

Box: 1 | Carton: 10 | Pallet: 180

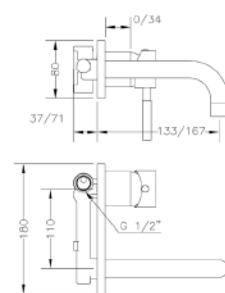

Ref.: 65131 18 45 66
 Monomando de lavabo empotrado caño 16 cm
 Built-in wash-basin mixer 16 cm spout

Box: 1 | Carton: 6 | Pallet: 108

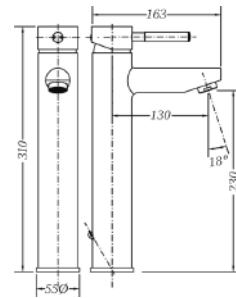

Ref.: 65136 18 45 66
 Monomando de lavabo alto
 High single lever wash-basin mixer

Box: 1 | Carton: 6 | Pallet: 108

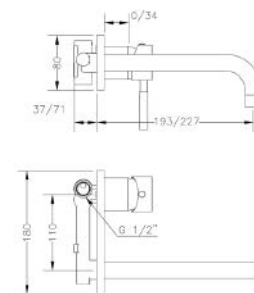

Ref.: 65132 18 45 66
 Monomando de lavabo empotrado caño 22 cm
 Built-in wash-basin mixer 22 cm spout

Box: 1 | Carton: 6 | Pallet: 144



serie Tau | Acabado cromado. Cartucho 40 | Chromed finish. Cartridge 40

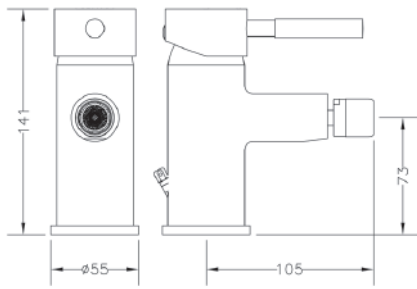

Ref.: 65145 18 45 66
Monomando de bidé
Single lever bidet mixer

Box: 1 | Carton: 8 | Pallet: 384

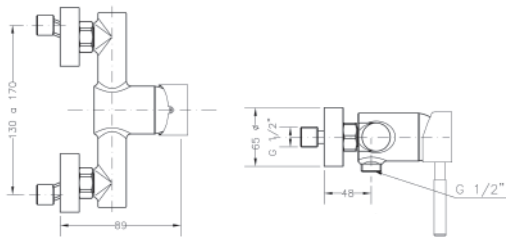

Ref.: 65110 18 45 66
Monomando de ducha con kit
Single lever shower mixer with kit

Box: 1 | Carton: 6 | Pallet: 108

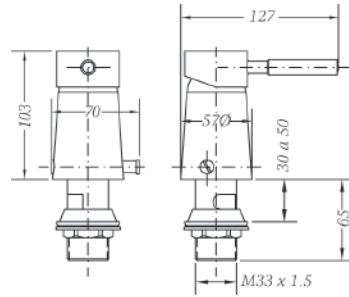

Ref.: 65142 18 45 66
Monomando de bidé con transmisión
Single lever bidet mixer with diverter

Box: 1 | Carton: 12 | Pallet: 216

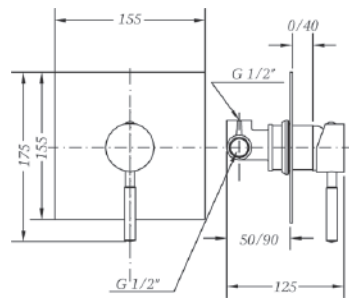

Ref.: 65115 18 45 66
Monomando de ducha empotrado
Built-in single lever shower mixer

Box: 1 | Carton: 12 | Pallet: 216

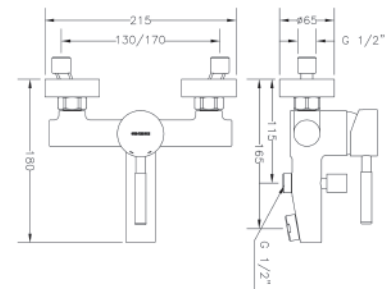

Ref.: 65100 18 45 66
Monomando de baño con kit
Single lever bath mixer with kit

Box: 1 | Carton: 6

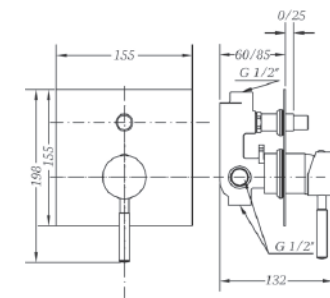

Ref.: 65116 18 45 66
Monomando de baño empotrado con inversor
Built-in single lever mixer bath with diverter

Box: 1 | Carton: 12 | Pallet: 216



serie Tau | Acabado cromado. Cartucho 40 | Chromed finish. Cartridge 40

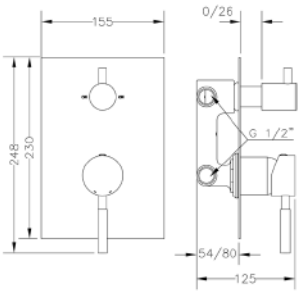

Ref.: 65117 18 45 66
 Monomando empotrado con inversor cerámico 2 vías
 Built-in single lever mixer with 2-way ceramic diverter

Box: 1 | Carton: 6 | Pallet: 108



100001 18 45 | 68998 30 45 | 100049 | 9908 0024 | PT117

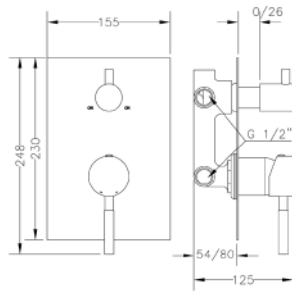

Ref.: 65118 18 45 66
 Monomando empotrado con inversor cerámico 3 vías
 Built-in single lever mixer with 3-way ceramic diverter

Box: 1 | Carton: 6 | Pallet: 108



100001 18 45 | 68998 30 45 | 100049 | 9908 0025 | PT118

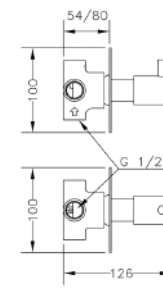

Ref.: 65114 30 45 66
 Inversor cerámico 3 vías empotrado con placa cuadrada
 Built-in 3-way ceramic diverter with square plate
Box: 1 | Carton: 8 | Pallet: 288



68998 30 45 | 9908 0025 | PT113

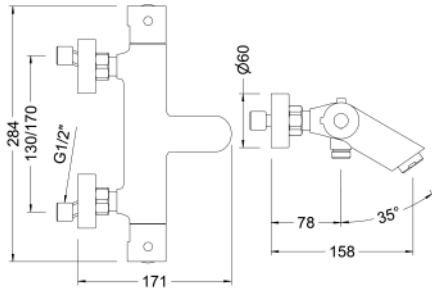

Ref.: 67102 14 45 67
 Termostática baño
 Thermostatic bath mixer

Box: 1 | Carton: 6 | Pallet: 144

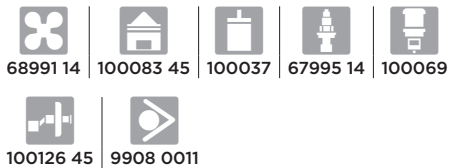

68991 14 | 100083 45 | 100037 | 67995 14 | 100069

100126 45 | 9908 0011

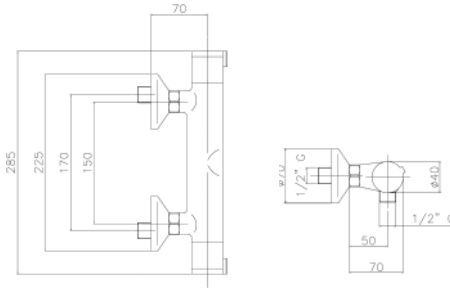

Ref.: 67112 14 45 67
 Termostática ducha
 Thermostatic shower mixer

Box: 1 | Carton: 12 | Pallet: 288



68991 14 | 100037 | 67995 14 | 100126 45 | 9908 0011

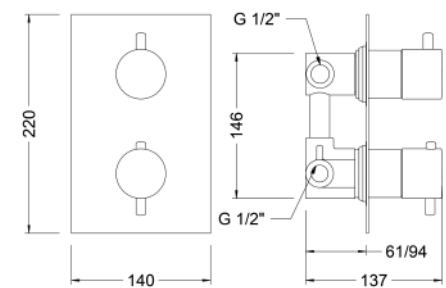

Ref.: 64114 14 45 67
 Termostática empotrada 2 vías
 Built-in 2-way thermostatic mixer

Box: 1 | Carton: 4 | Pallet: 72



9908 0056 | 9908 0100 | 9908 0101 | 9908 0051

9908 0052 | 9908 0053 | 9908 0012

serie Tau | Acabado cromado. Cartucho 40 | Chromed finish. Cartridge 40

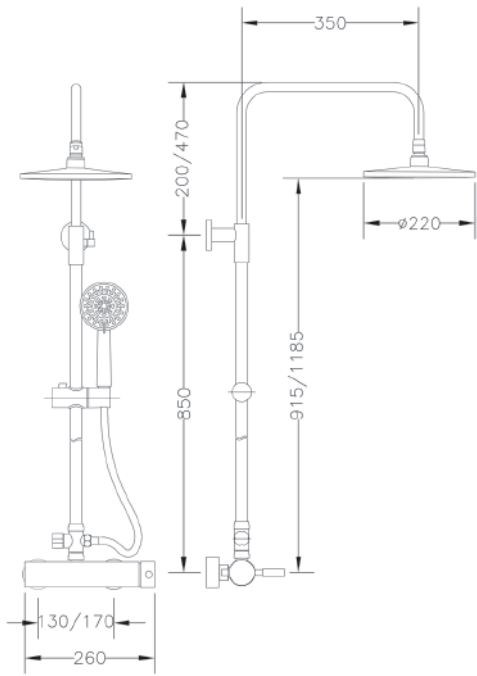

Ref.: CM65110 18

Columna monomando extensible con kit
Single lever extensible column with kit

Box: 1 | Carton: 2 | Pallet: 8

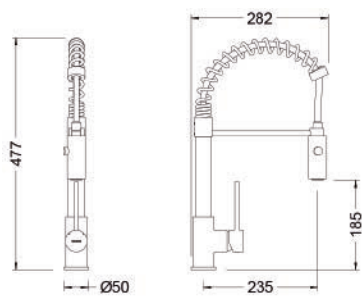
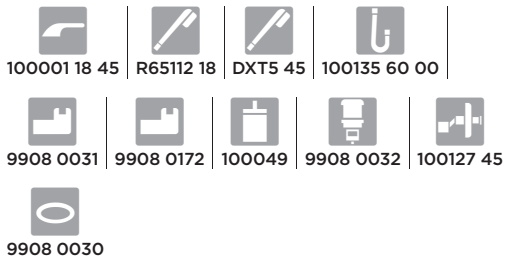

Ref.: 65211 18 45 66

Monomando de fregadera con muelle
Single lever sink mixer with spring

Box: 1 | Carton: 4 | Pallet: 36

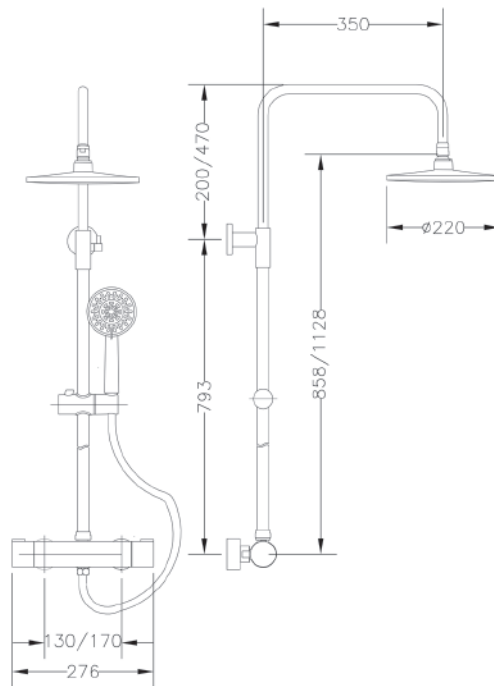
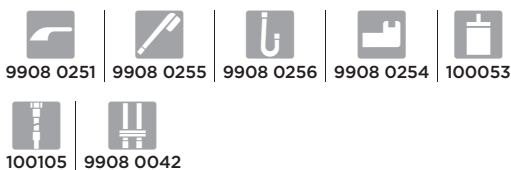

Ref.: CT67110 18

Columna termostática extensible con kit
Thermostatic extensible column with kit

Box: 1 | Carton: 2 | Pallet: 8

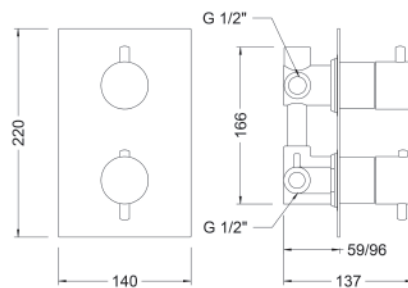
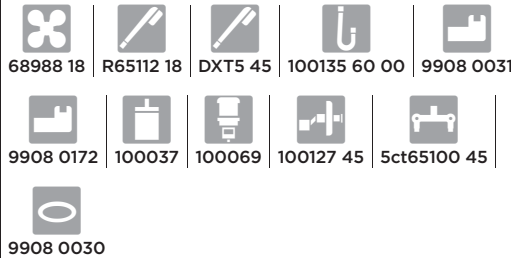

Ref.: 64111 14 45 67

Termostática empotrada 3 vías
Built-in 3-way thermostatic

Box: 1 | Carton: 4 | Pallet: 72

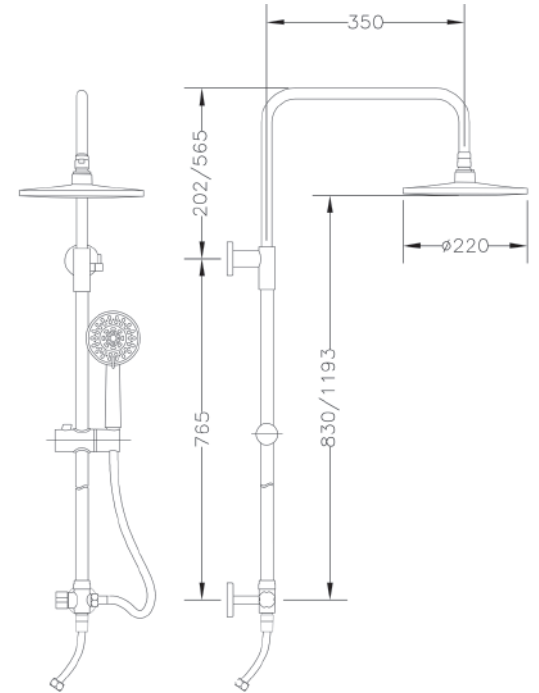

Ref.: 1745 45

Set columna extensible con ducha, soporte y flexo
Extensible column set with shower, holder and flexible hose

Box: 1 | Carton: 2 | Pallet: 8



serie Tau | Acabado cromado. Cartucho 40 | Chromed finish. Cartridge 40

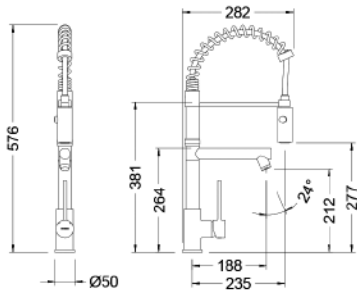

Ref.: 65212 18 45 66

Monomando de fregadera con muelle y caño
Single lever sink mixer with spring and spout

Box: 1 | Carton: 4 | Pallet: 36

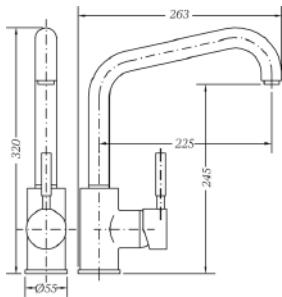

Ref.: 65204 18 45 66

Monomando de fregadera cartucho 40
Single lever sink mixer 40 cartridge

Box: 1 | Carton: 5 | Pallet: 135

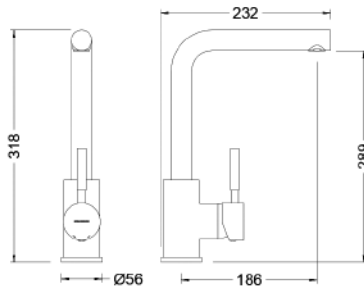

Ref.: 65214 18 45 66

Monomando de fregadera cartucho 40
Single lever sink mixer 40 cartridge

Box: 1 | Carton: 5 | Pallet: 135

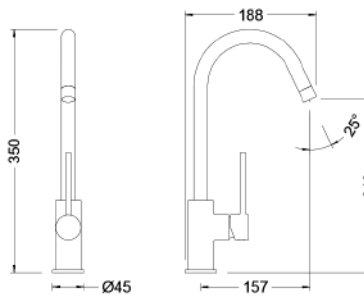

Ref.: 65403 18 45 66

Monomando de fregadera cartucho 25 apertura
en frío
Single lever sink mixer 25 cartridge cold start

Box: 1 | Carton: 8 | Pallet: 96

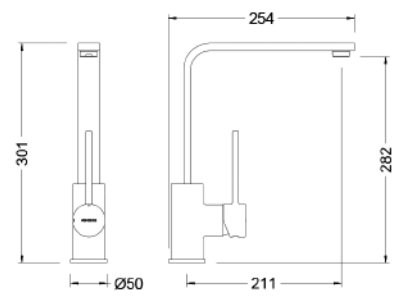

Ref.: 65404 18 45 66

Monomando de fregadera cartucho 35 apertura
en frío
Single lever sink mixer 35 cartridge cold start

Box: 1 | Carton: 8 | Pallet: 96



serie Tau | Acabado cromado. Cartucho 40 | Chromed finish. Cartridge 40

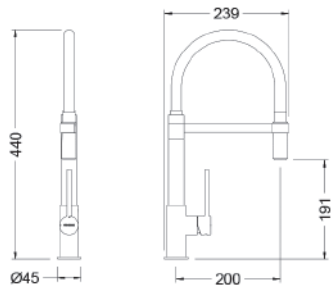

Ref.: 65219 18 45 66

Monomando de fregadera cartucho 25 apertura en frío
Single lever sink mixer 25 cartridge cold start

Box: 1 | Carton: 4 | Pallet: 48

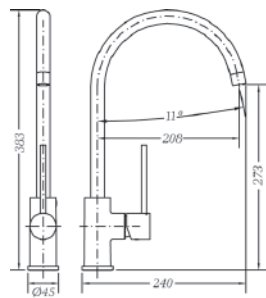

Ref.: FRT65401

Monomando de fregadera cartucho 25 apertura en frío
Single lever sink mixer 25 cartridge cold start

Box: 1 | Carton: 8 | Pallet: 96

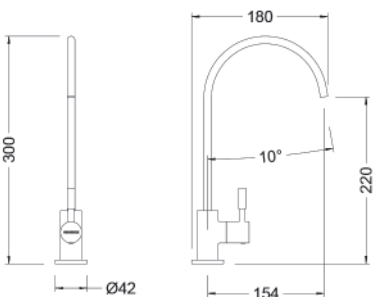

Ref.: 65700 18 45 66

Grifo de 1 vía
One way tap

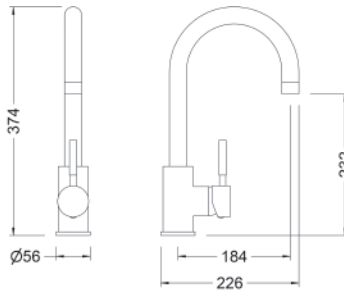

Ref.: 65203 18 45 66

Monomando de fregadera cartucho 40
Single lever sink mixer 40 cartridge

Box: 1 | Carton: 5 | Pallet: 90

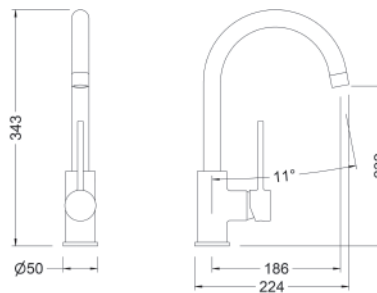

Ref.: FRT65402

Monomando de fregadera cartucho 35 apertura en frío
Single lever sink mixer 35 cartridge cold start

Box: 1 | Carton: 8 | Pallet: 96

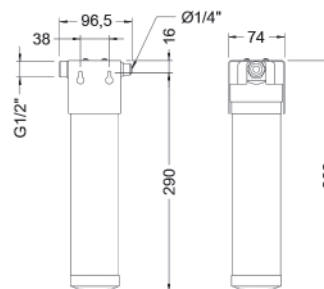

Ref.: FT00

Kit declorador
Filtro declorador

Box: 80 | Carton: 960 | Pallet: 7680

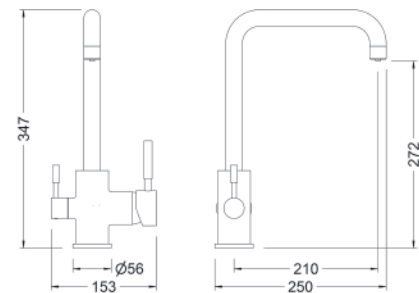

Ref.: 65702 18 45 66

Monomando de fregadera 3 vías
Single lever 3-way sink mixer

Box: 1 | Carton: 4 | Pallet: 96

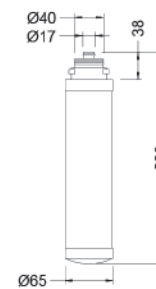
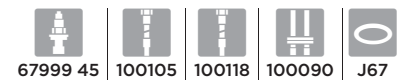

Ref.: FT92

Filtro declorador
Declorator filter

Box: 80 | Carton: 960 | Pallet: 7680

serie Tau | Acabado cromado. Cartucho 40 | Chromed finish. Cartridge 40

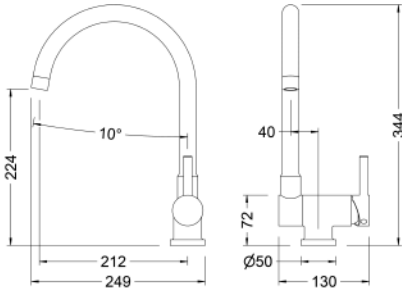

Ref.: 65900 18 45 66

Monomando de fregadera abatible cartucho 35
apertura en frío
Single lever folding sink mixer 35 cartridge cold
start

Box: 1 | Carton: 8 | Pallet: 96

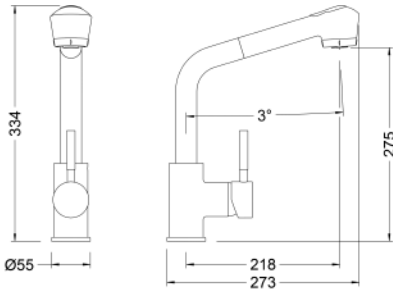
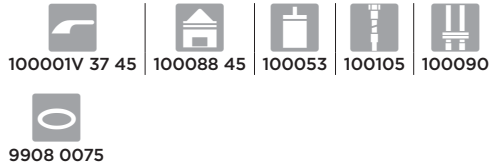

Ref.: 65205 18 45 66

Monomando de fregadera ducha extraíble
Single lever sink mixer with pull-out spray

Box: 1 | Carton: 6 | Pallet: 108

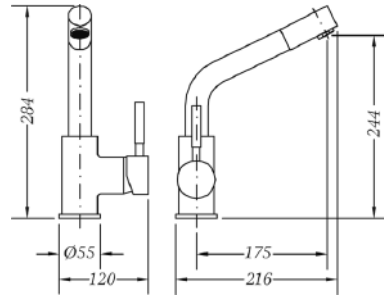
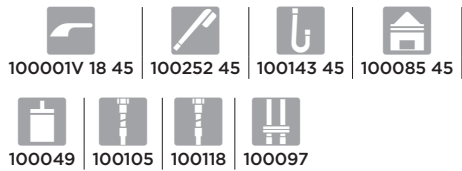

Ref.: 65206 18 45 66

Monomando de fregadera caño extraíble
Single lever sink mixer with pull-out spout

Box: 1 | Carton: 8 | Pallet: 192

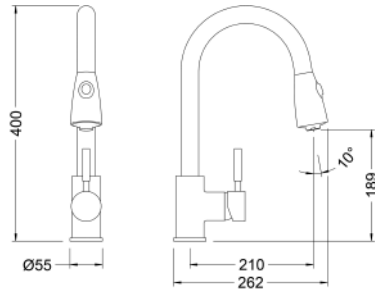
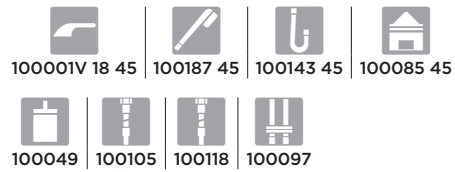

Ref.: FRV61205

Monomando de fregadera ducha extraíble
Single lever sink mixer with pull-out spray

Box: 1 | Carton: 6 | Pallet: 108

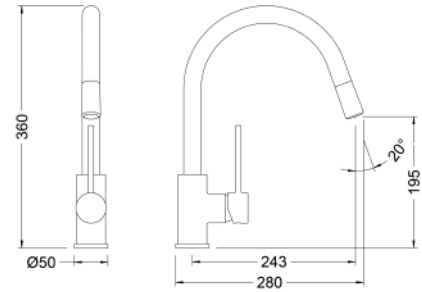
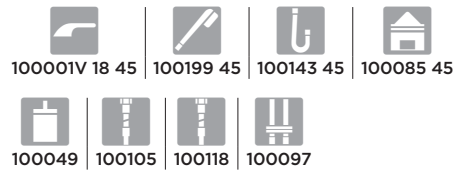

Ref.: FRV61206

Monomando de fregadera caño extraíble
Single-lever sink mixer with pull-out spout

Box: 1 | Carton: 8 | Pallet: 96

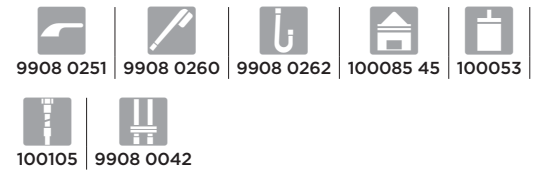

serie Tau | Acabado cromado. Cartucho 40 | Chromed finish. Cartridge 40

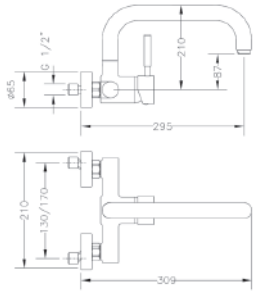

Ref.: 65192 18 45 66
 Monomando de fregadera mural 15 cm
 Wall single lever sink mixer 15 cm

Box: 1 | Carton: 4 | Pallet: 72



100001V 18 45 | 100085 45 | 100049 | 100127 45

serie Tau 2 | Acabado cromado. Cartucho 40 | Chromed finish. Cartridge 40

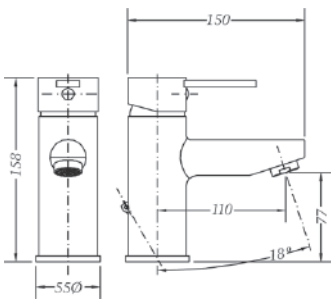

Ref.: 65135 29 45 66
 Monomando de lavabo
 Single lever wash-basin mixer

Box: 1 | Carton: 12 | Pallet: 216



100001 29 45 | 100085 45 | 100051 | 100105 | 100091

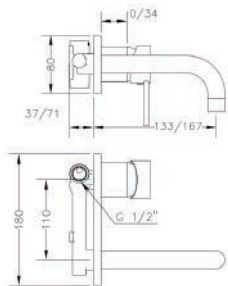

Ref.: 65131 29 45 66
 Monomando de lavabo empotrado caño 16 cm
 Built-in wash-basin mixer 16 cm spout

Box: 1 | Carton: 6 | Pallet: 144



100001 29 45 | 68924 45 | 100088 45 | 100049 | PT131

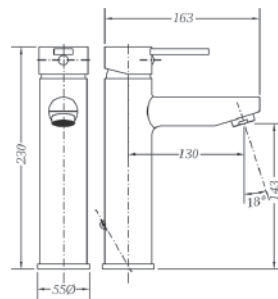

Ref.: 65134 29 45 66
 Monomando de lavabo medio alto
 Medium height single lever wash-basin mixer

Box: 1 | Carton: 10 | Pallet: 180



100001 29 45 | 100085 45 | 100049 | 100103 | 100091

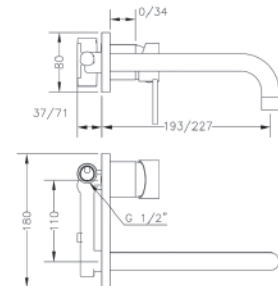

Ref.: 65132 29 45 66
 Monomando de lavabo empotrado caño 22 cm
 Built-in wash-basin mixer 22 cm spout

Box: 1 | Carton: 6 | Pallet: 144



100001 29 45 | 68925 45 | 100088 45 | 100049 | PT131

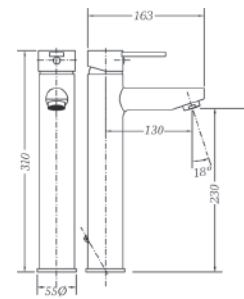

Ref.: 65136 29 45 66
 Monomando de lavabo alto
 High single lever wash-basin mixer

Box: 1 | Carton: 6 | Pallet: 108



100001 29 45 | 100085 45 | 100049 | 100103 | 100091

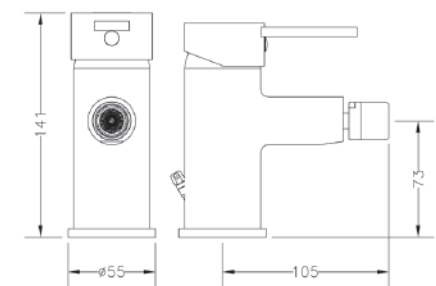

Ref.: 65145 29 45 66
 Monomando de bidé
 Single lever bidet mixer

Box: 1 | Carton: 8 | Pallet: 384



100001 29 45 | 100086 45 | 100051 | 100105 | 100091

serie Tau 2 | Acabado cromado. Cartucho 40 | Chromed finish. Cartridge 40

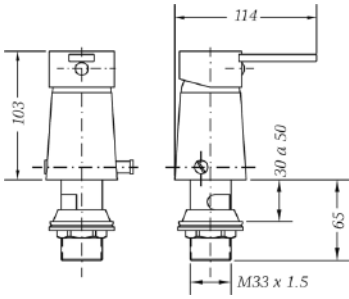

Ref.: 65142 29 45 66
 Monomando de bidé con transmisión
 Single lever bidet mixer with diverter

Box: 1 | Carton: 12 | Pallet: 216

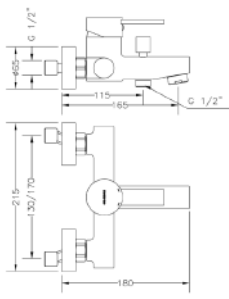

Ref.: 65100 29 45 66
 Monomando de baño con kit
 Single lever bath mixer with kit

Box: 1 | Carton: 6 | Pallet: 108

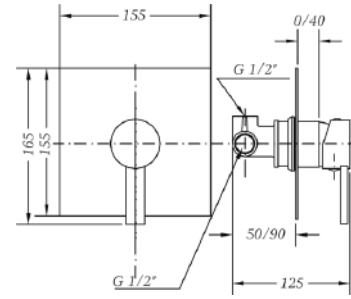

Ref.: 65115 29 45 66
 Monomando de ducha empotrado
 Built-in single lever shower mixer

Box: 1 | Carton: 12 | Pallet: 216

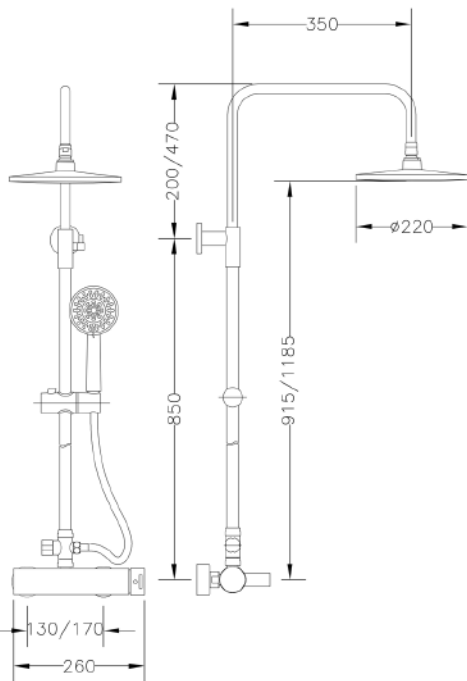

Ref.: CM65110 29
 Columna monomando extensible con kit
 Single lever extensible column with kit

Box: 1 | Carton: 2 | Pallet: 8

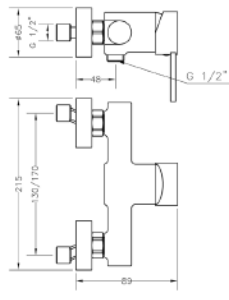

Ref.: 65110 29 45 66
 Monomando de ducha con kit
 Single lever shower mixer with kit

Box: 1 | Carton: 6 | Pallet: 108

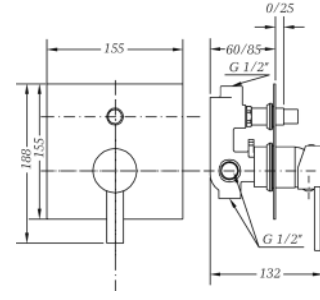

Ref.: 65116 29 45 66
 Monomando de baño empotrado con inversor
 Built-in single lever bath mixer with diverter

Box: 1 | Carton: 12 | Pallet: 216



serie Kenjo | Acabado cromado. Cartucho 35 | Chromed finish. Cartridge 35

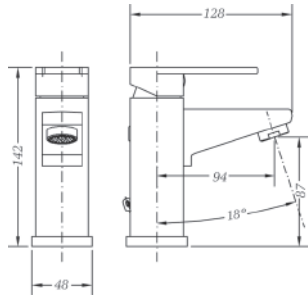

Ref.: 63130 26 45 66
Monomando de lavabo
Single lever wash-basin mixer

Box: 1 | Carton: 20 | Pallet: 360

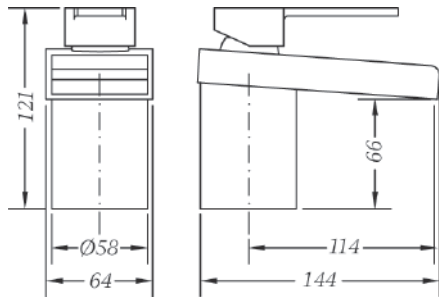

Ref.: 63137 26 45 66
Monomando de lavabo cascada
Waterfall single lever wash-basin mixer

Box: 1 | Carton: 20 | Pallet: 360

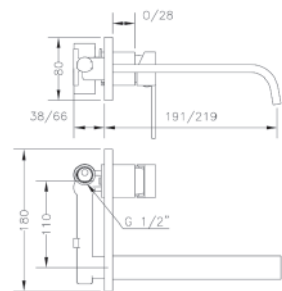

Ref.: 63132 26 45 66
Monomando de lavabo empotrado caño 22 cm
Built-in wash-basin mixer 22 cm spout

Box: 1 | Carton: 6 | Pallet: 144

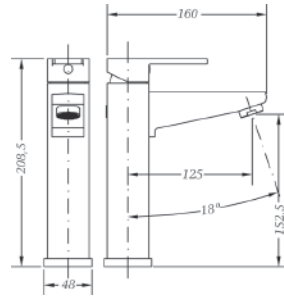

Ref.: 63134 26 45 66
Monomando de lavabo medio alto
Medium height single lever wash-basin mixer

Box: 1 | Carton: 8 | Pallet: 192

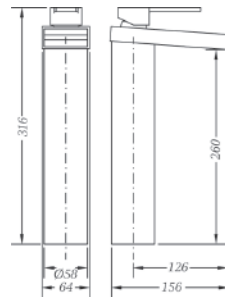

Ref.: 63138 26 45 66
Monomando de lavabo cascada alto
High waterfall single lever wash-basin mixer

Box: 1 | Carton: 6 | Pallet: 108

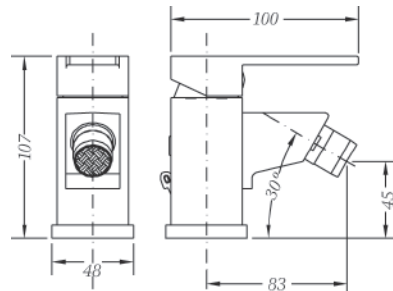

Ref.: 63140 26 45 66
Monomando de bidé
Single lever bidet mixer

Box: 1 | Carton: 20 | Pallet: 360

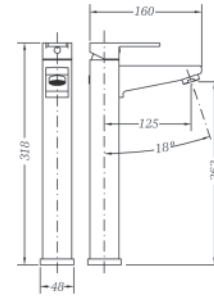

Ref.: 63136 26 45 66
Monomando de lavabo alto
High single lever wash-basin mixer

Box: 1 | Carton: 6 | Pallet: 108

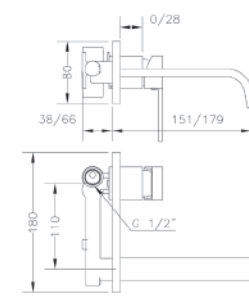

Ref.: 63131 26 45 66
Monomando de lavabo empotrado caño 16 cm
Built-in wash-basin mixer 16 cm spout

Box: 1 | Carton: 6 | Pallet: 144

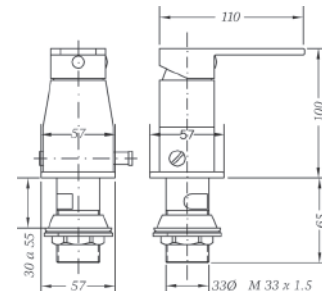

Ref.: 63142 26 45 66
Monomando de bidé con transmisión
Single lever bidet mixer with diverter

Box: 1 | Carton: 12 | Pallet: 216



serie Kenjo | Acabado cromado. Cartucho 35 | Chromed finish. Cartridge 35

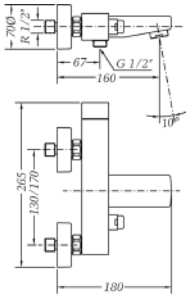

Ref.: 63100 26 45 67
 Monomando de baño sin kit
 Single lever bath mixer without kit

Box: 1 | Carton: 6 | Pallet: 108

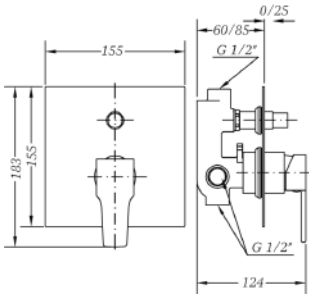

Ref.: 63116 26 45 66
 Monomando de baño empotrado con inversor
 Built-in single lever bath with mixer with diverter

Box: 1 | Carton: 12 | Pallet: 216

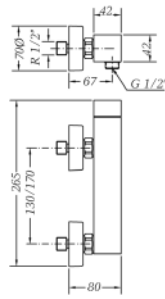

Ref.: 63110 26 45 67
 Monomando de ducha sin kit
 Single lever shower mixer without kit

Box: 1 | Carton: 10 | Pallet: 180

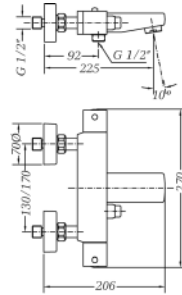

Ref.: 67100 26 45 67
 Termostática de baño sin kit
 Thermostatic bath mixer without kit

Box: 1 | Carton: 6 | Pallet: 288

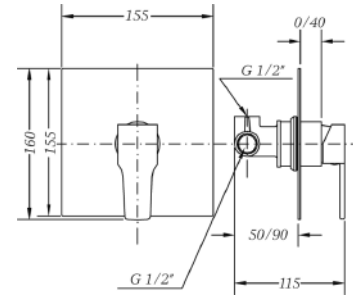

Ref.: 63115 26 45 66
 Monomando de ducha empotrado
 Built-in single lever shower mixer

Box: 1 | Carton: 12 | Pallet: 216

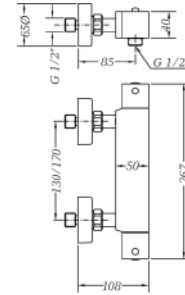

Ref.: 67110 26 45 67
 Termostática ducha sin kit
 Thermostatic shower mixer without kit

Box: 1 | Carton: 9 | Pallet: 216



serie Kenjo | Acabado cromado. Cartucho 35 | Chromed finish. Cartridge 35

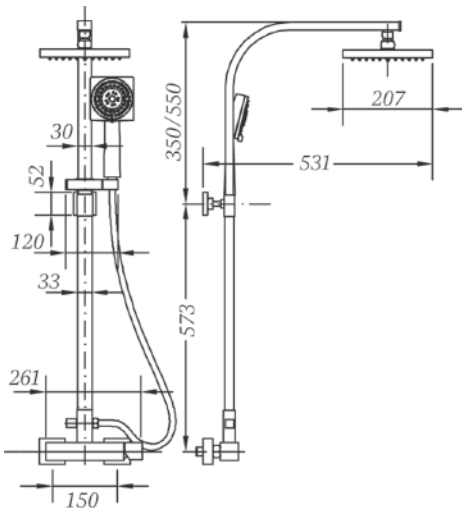

Ref.: CM63110 26

Columna monomando extensible con kit
Single lever extensible column with kit

Box: 1 | Carton: 2 | Pallet: 8

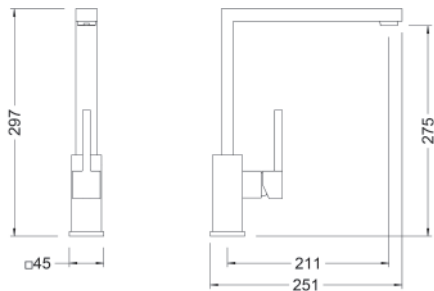

Ref.: FRK63400

Monomando de fregadera cartucho 25
Single lever sink mixer 25 cartridge

Box: 1 | Carton: 8 | Pallet: 96

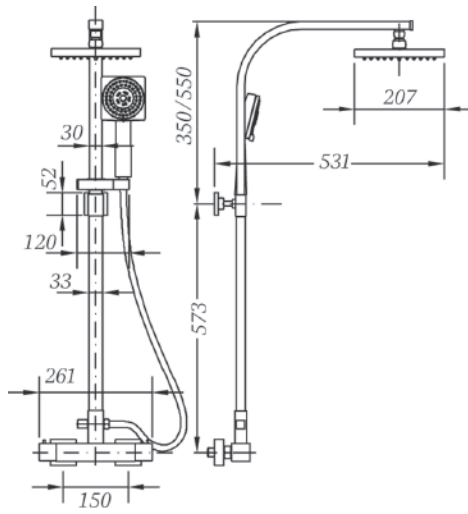
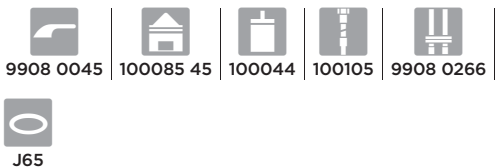

Ref.: CT67110 26

Columna termostática extensible con kit
Thermostatic extensible column with kit

Box: 1 | Carton: 2 | Pallet: 8

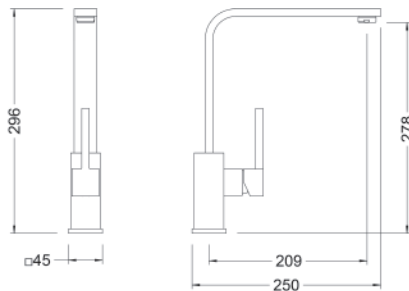
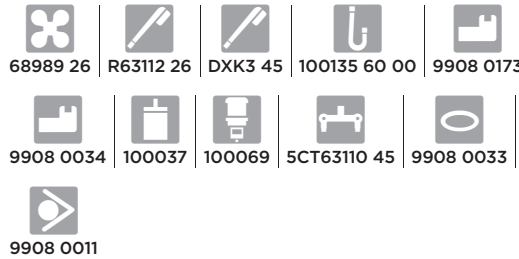

Ref.: FRK63401

Monomando de fregadera cartucho 25
Single lever sink mixer 25 cartridge

Box: 1 | Carton: 8 | Pallet: 96

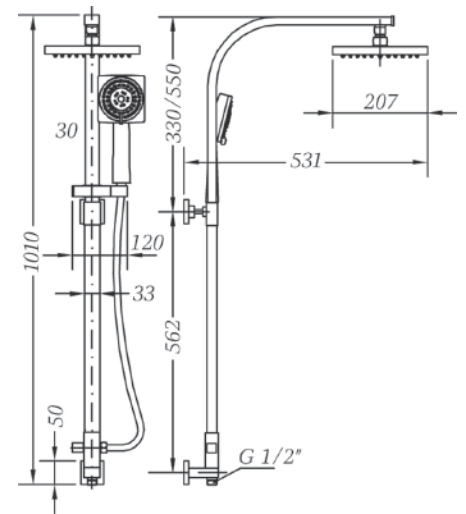
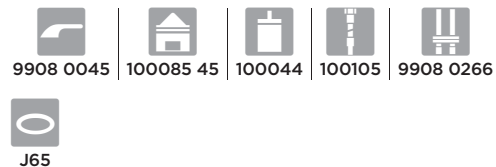

Ref.: 1746 45

Set columna extensible con ducha, soporte y flexo
Extensible column set with shower, holder and flexible hose

Box: 1 | Carton: 2 | Pallet: 8



serie Inox | Acero Inoxidable. Cartucho 35 | Stainless Steel. Cartridge 35

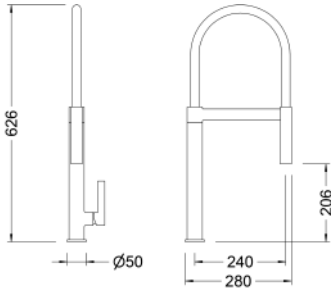

Ref.: 65219 40 60 66
 Monomando de fregadera cartucho 25
 Single lever sink mixer 25 cartridge

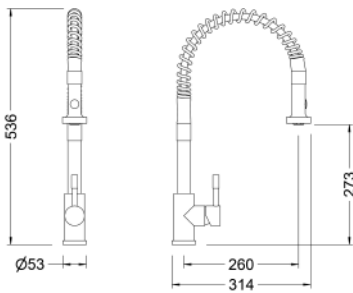

Ref.: 65207 18 60 66
 Monomando de fregadera inox con muelle y ducha extraíble
 Stainless steel single lever sink mixer with spring and pull-out sprayer

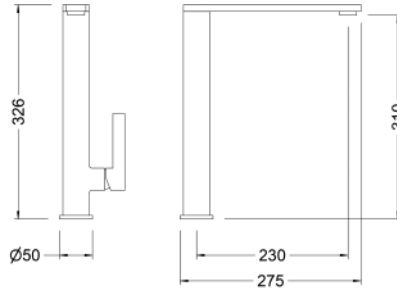

Ref.: 65215 40 60 66
 Monomando de fregadera cartucho 25
 Single lever sink mixer 25 cartridge

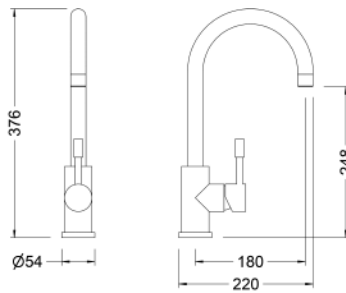

Ref.: 65203 18 60 66
 Monomando de fregadera inox caño cisne
 Stainless steel single lever sink mixer with swan spout

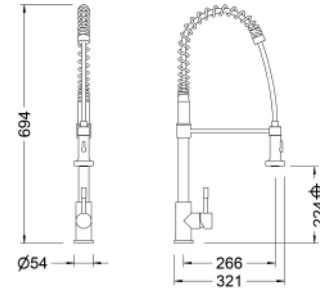
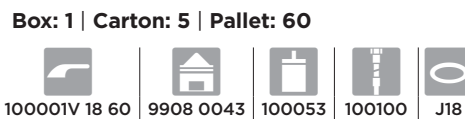

Ref.: 65211 18 60 66
 Monomando de fregadera inox con muelle
 Stainless steel single lever sink mixer with spring

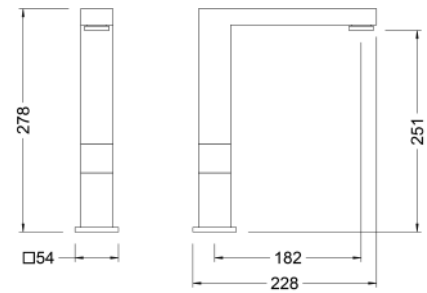
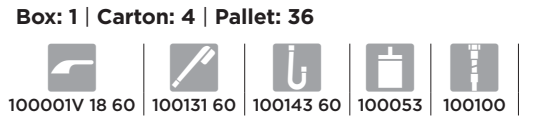

Ref.: 65208 18 60 66
 Monomando de fregadera inox con cartucho progresivo
 Stainless steel sink mixer with progressive cartridge

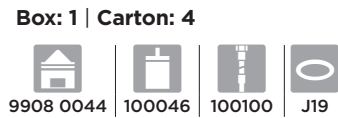

serie K8 | Acabado cromado. Cartucho 40 | Chromed finish. Cartridge 40

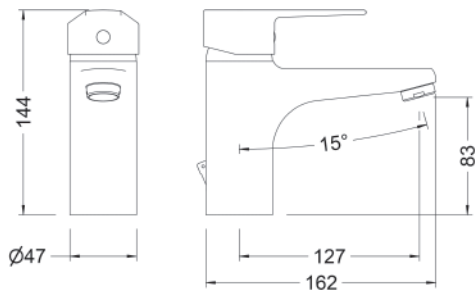

Ref.: 60134 28 45 66
 Monomando de lavabo medio alto
 Medium height single lever wash-basin mixer

Box: 1 | Carton: 8 | Pallet: 240

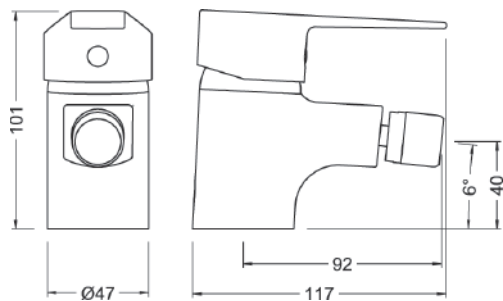

Ref.: 60140 28 45 66
 Monomando de bidé
 Single lever bidet mixer

Box: 1 | Carton: 20 | Pallet: 360

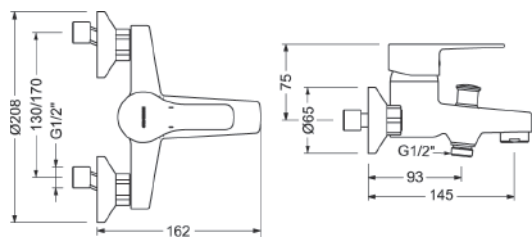

Ref.: 60100 28 45 66
 Monomando de baño con kit
 Single lever bath mixer with kit

Box: 1 | Carton: 8 | Pallet: 128

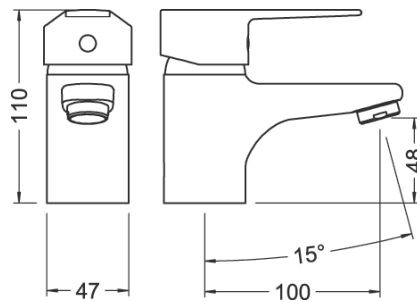

Ref.: 60130 28 45 66
 Monomando de lavabo
 Single lever wash-basin mixer

Box: 1 | Carton: 20 | Pallet: 360

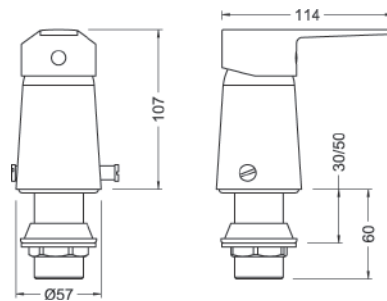

Ref.: 61142 28 45 66
 Monomando de bidé con transmisión
 Single lever bidet mixer with diverter

Box: 1 | Carton: 12 | Pallet: 216

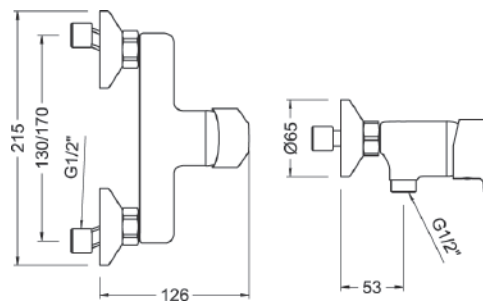

Ref.: 60110 28 45 66
 Monomando de ducha con kit
 Single lever shower mixer with kit

Box: 1 | Carton: 8 | Pallet: 128

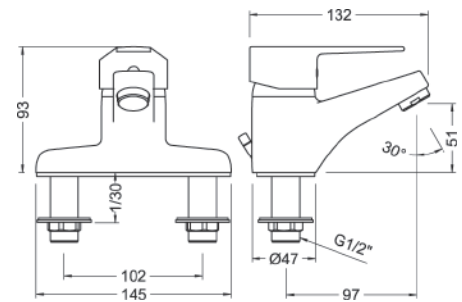

Ref.: 60188 28 45 66
 Monomando de lavabo centerset 4"
 Single lever wash-basin mixer 4" centerset

Box: 1 | Carton: 12 | Pallet: 216

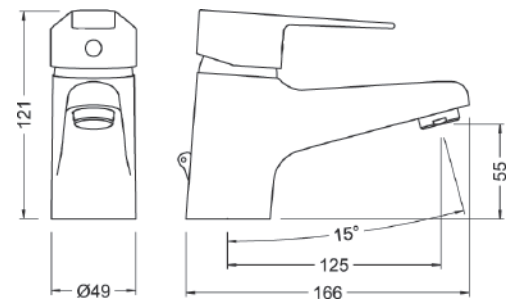

Ref.: 61130 28 45 66
 Monomando de lavabo Plus
 Single lever Plus wash-basin mixer

Box: 1 | Carton: 20 | Pallet: 360

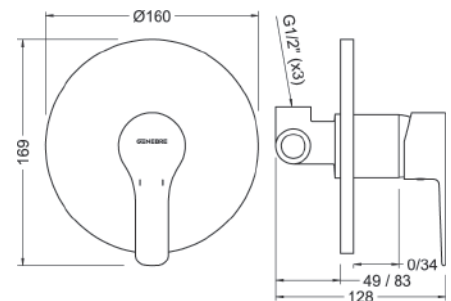

Ref.: 61115 28 45 66
 Monomando de ducha empotrado
 Built-in single lever shower mixer

Box: 1 | Carton: 12 | Pallet: 216



serie K8 | Acabado cromado. Cartucho 40 | Chromed finish. Cartridge 40

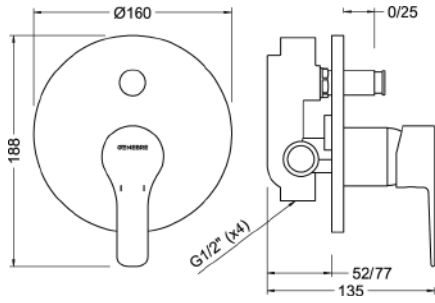

Ref.: 61116 28 45 66
 Monomando de baño empotrado con inversor
 Built-in single lever bath mixer with diverter

Box: 1 | Carton: 12 | Pallet: 216

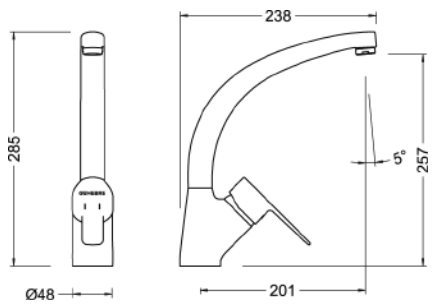

Ref.: 61204 28 45 66
 Monomando de fregadera caño conformado
 Single-lever sink mixer tube spout

Box: 1 | Carton: 6 | Pallet: 108

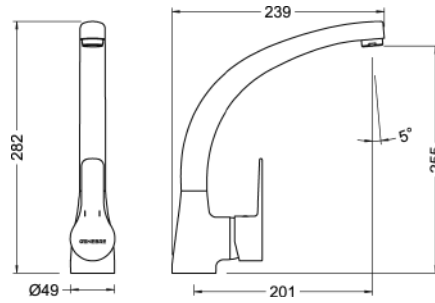

Ref.: 61201 28 45 66
 Monomando de fregadera caño fundido
 Single lever sink mixer casted spout

Box: 1 | Carton: 6 | Pallet: 108

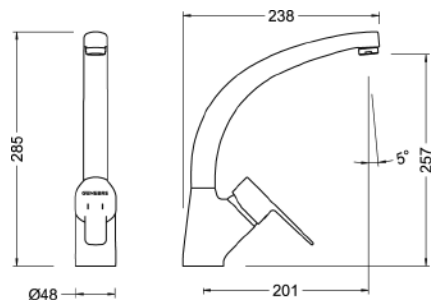

Ref.: 61210 28 45 66
 Monomando de fregadera caño fundido
 Single lever sink mixer casted spout

Box: 1 | Carton: 6 | Pallet: 108

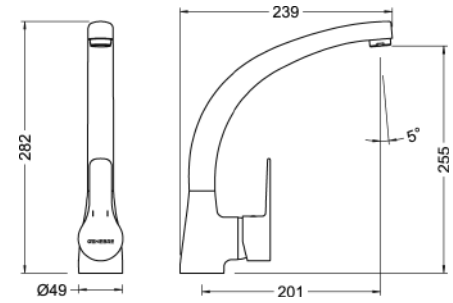

Ref.: 61203 28 45 66
 Monomando de fregadera caño conformado
 Single-lever sink mixer tube spout

Box: 1 | Carton: 6 | Pallet: 108

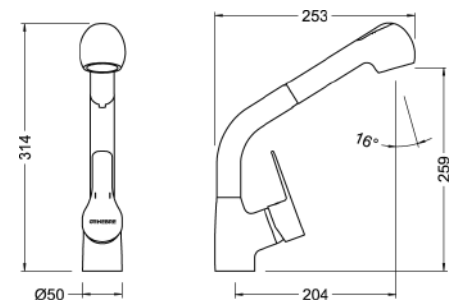

Ref.: 61206 28 45 66
 Monomando de fregadera ducha extraíble
 Single-lever sink mixer with pull-out spray

Box: 1 | Carton: 10 | Pallet: 108



serie K8 | Acabado cromado. Cartucho 40 | Chromed finish. Cartridge 40

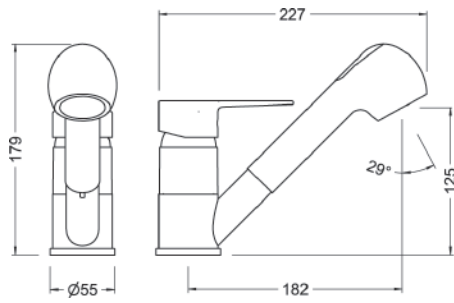

Ref.: 61205 28 45 66
 Monomando de fregadera ducha extraíble
 Single lever sink mixer with pull-out spray

Box: 1 | Carton: 9 | Pallet: 162

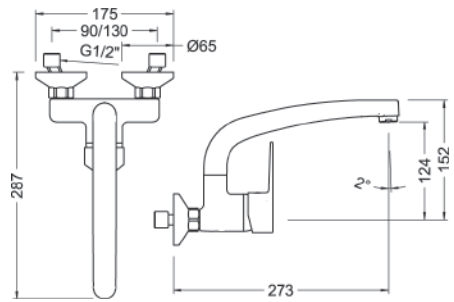
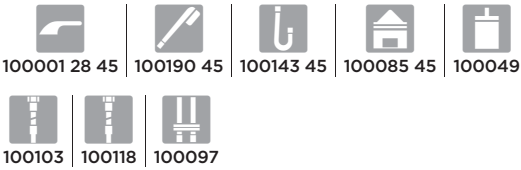

Ref.: 61195 28 45 66
 Monomando de fregadera mural 11 cm
 Wall single lever sink mixer 11 cm

Box: 1 | Carton: 9 | Pallet: 162

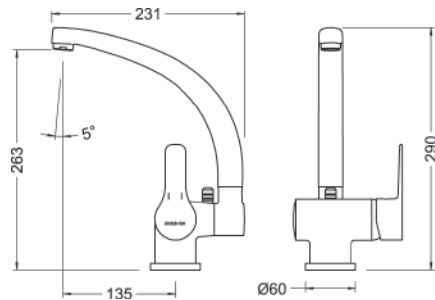

Ref.: 61900 28 45 66
 Monomando de fregadera abatible
 Single lever folding sink mixer

Box: 1 | Carton: 8 | Pallet: 128

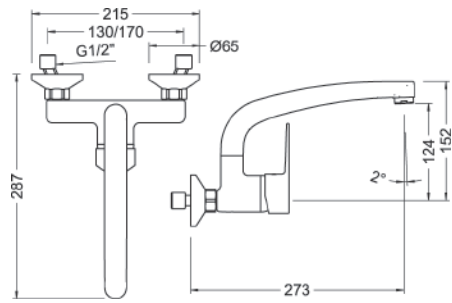
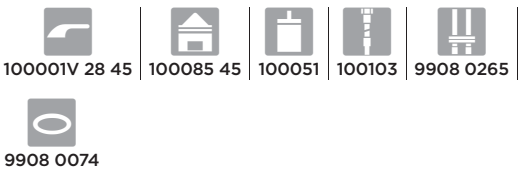

Ref.: 61192 28 45 66
 Monomando de fregadera mural 15 cm
 Wall single-lever sink mixer 15 cm

Box: 1 | Carton: 6 | Pallet: 72

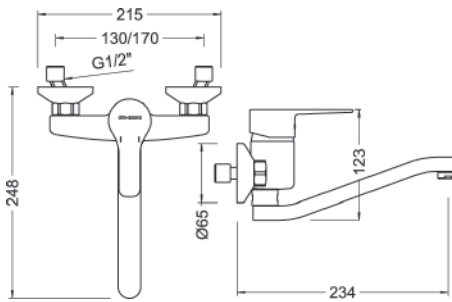

Ref.: 61196 28 45 66
 Monomando de fregadera caño inferior elevado
 Wall single lever sink mixer low spout

Box: 1 | Carton: 8 | Pallet: 192

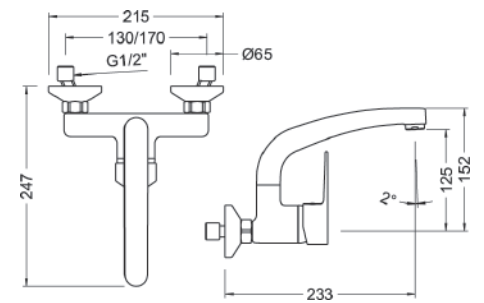

Ref.: 61190 28 45 66
 Monomando de fregadera mural 15 cm caño corto
 Wall single lever sink mixer 15 cm short spout

Box: 1 | Carton: 6 | Pallet: 108

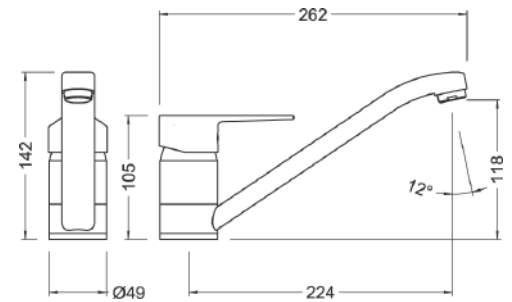

Ref.: 61200 28 45 66
 Monomando de fregadera
 Single lever sink mixer

Box: 1 | Carton: 9 | Pallet: 288



serie Ge2 | Acabado cromado. Cartucho 40 | Chromed finish. Cartridge 40

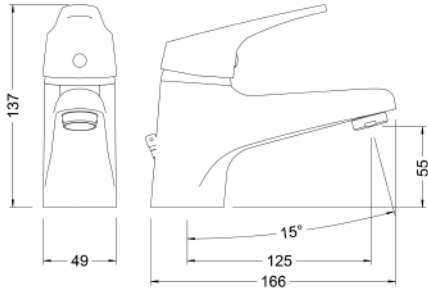

Ref.: 61130 22 45 66
Monomando de lavabo Plus
Single lever Plus wash-basin mixer

Box: 1 | Carton: 20 | Pallet: 360



100001 22 45 | 100085 45 | 100049 | 100103 | 100092

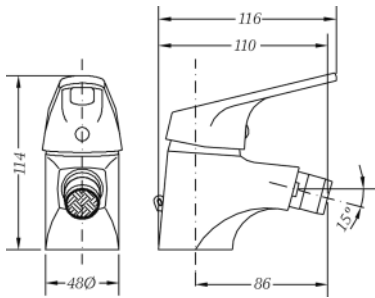

Ref.: 60140 22 45 66
Monomando de bidé
Single lever bidet mixer

Box: 1 | Carton: 8 | Pallet: 480



100001 22 45 | 100086 45 | 100049 | 100103 | 100092

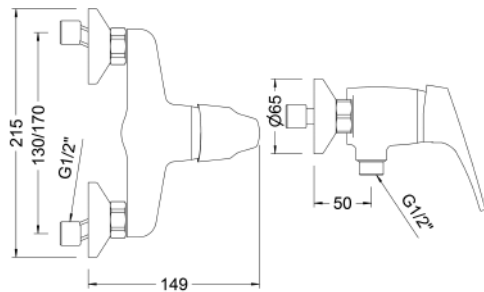

Ref.: 60110 22 45 66
Monomando de ducha con kit
Single lever shower mixer with kit

Box: 1 | Carton: 8 | Pallet: 160

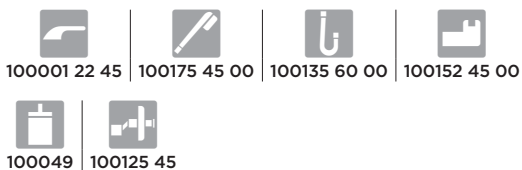

100001 22 45 | 100175 45 00 | 100135 60 00 | 100152 45 00

100049 | 100125 45

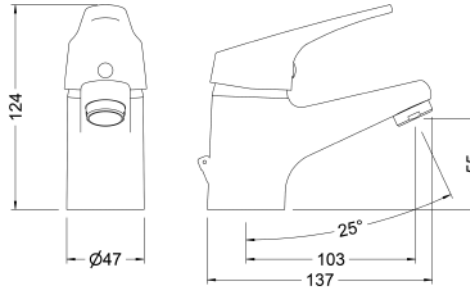

Ref.: 60130 22 45 66
Monomando de lavabo
Single lever wash-basin mixer

Box: 1 | Carton: 20 | Pallet: 540



100001 22 45 | 100085 45 | 100049 | 100103 | 100092

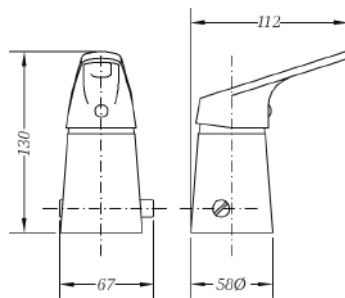

Ref.: 61142 22 45 66
Monomando de bidé con transmisión
Single lever bidet mixer with diverter

Box: 1 | Carton: 12 | Pallet: 216



100001 22 45 | 100051 | 100104 | 100111 | J15

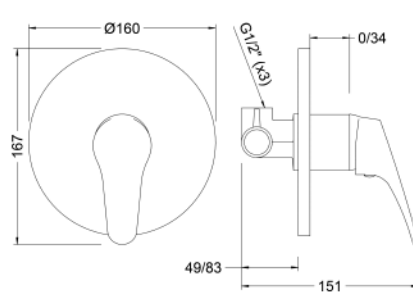

Ref.: 61115 22 45 66
Monomando de ducha empotrado
Built-in single lever shower mixer

Box: 1 | Carton: 12 | Pallet: 216



100001 22 45 | 100049 | PS115

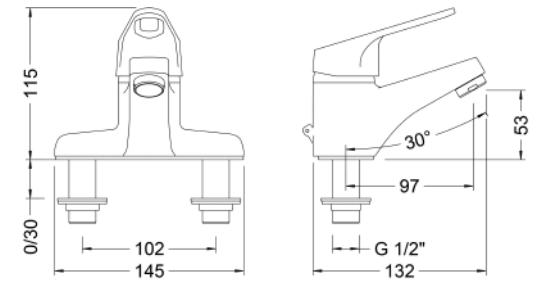

Ref.: 60188 22 45 66
Monomando de lavabo centerset 4"
Single lever wash-basin mixer 4" centerset

Box: 1 | Carton: 12 | Pallet: 216



100001 22 45 | 100085 45 | 100049 | 100098

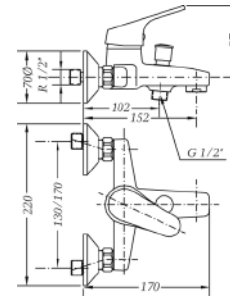

Ref.: 60100 22 45 66
Monomando de baño con kit
Single lever bath mixer with kit

Box: 1 | Carton: 8 | Pallet: 128



100001 22 45 | 100175 45 00 | 100135 60 00 | 100152 45 00



100083 45 | 100049 | 100160 45 | 100125 45

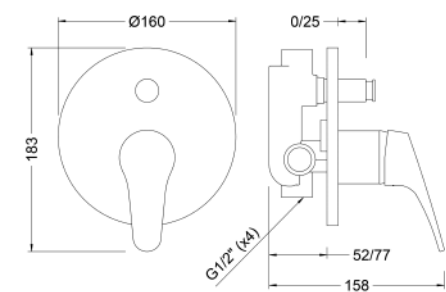

Ref.: 61116 22 45 66
Monomando de baño empotrado con inversor
Built-in single lever bath mixer with diverter

Box: 1 | Carton: 12 | Pallet: 216



100001 22 45 | 100049 | 100162 45 | PS116

serie Ge2 | Acabado cromado. Cartucho 40 | Chromed finish. Cartridge 40

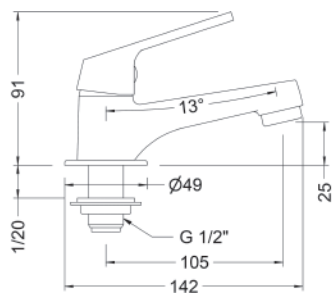

Ref.: 1002 04
Grifo lavabo 1 agua cartucho 25
One-water wash-basin tap 25 cartridge

Box: 1 | Carton: 54 | Pallet: 972

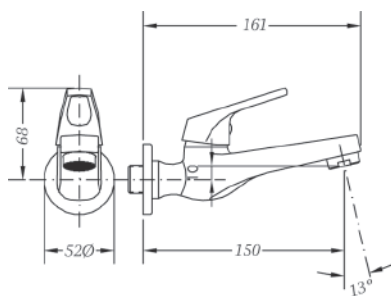

Ref.: 1003 04
Grifo lavabo mural 1 agua cartucho 25
One-water wall wash-basin tap 25 cartridge

Box: 1 | Carton: 48 | Pallet: 864

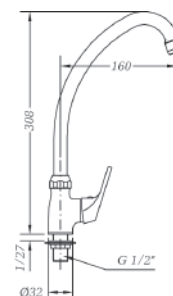

Ref.: 1009 04
Grifo fregadera 1 agua cartucho 25
One-water sink tap 25 cartridge

Box: 1 | Carton: 30 | Pallet: 540

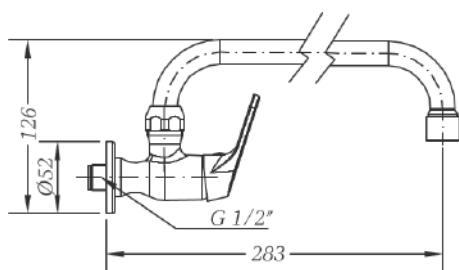

Ref.: 1008 04
Grifo mural con tubo 24 cm 1 agua cartucho 25
One-water wall sink tap spout 24 cm 25 cartridge

Box: 1 | Carton: 27 | Pallet: 540

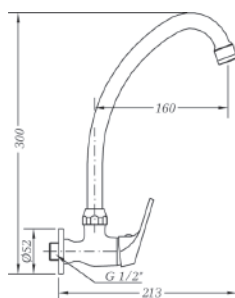

Ref.: 1005 04
Grifo mural con tubo alto 1 agua cartucho 25
One-water wall sink tap high spout 25 cartridge

Box: 1 | Carton: 30 | Pallet: 540

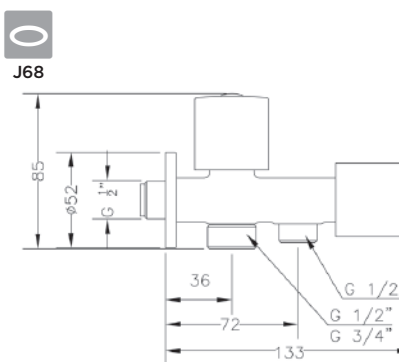

Ref.: 1023 04
Grifo doble combinable 1/2\"/>

Box: 1 | Carton: 48 | Pallet: 864

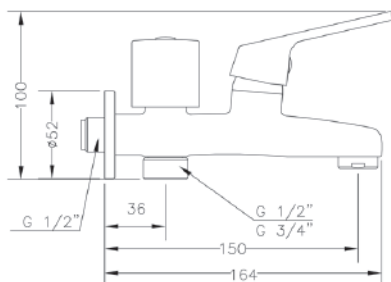

Ref.: 1024 04
Grifo doble combinable a 1/2\"/>

Box: 1 | Carton: 48 | Pallet: 864

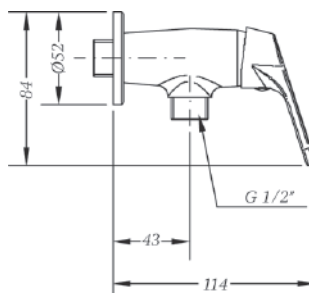

Ref.: 60001 22 45 67
Grifo bide mural 1 agua
1 water wall bidet

Box: 1 | Carton: 54 | Pallet: 972

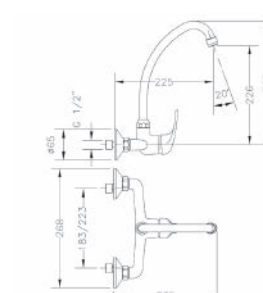

Ref.: 60194 05 45 66
Monomando de fregadera mural 8\"/>

Box: 1 | Carton: 6 | Pallet: 162



serie Ge2 | Acabado cromado. Cartucho 40 | Chromed finish. Cartridge 40

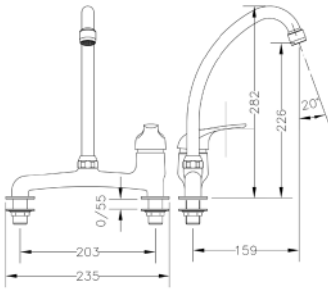

Ref.: 60198 05 45 66
Monomando mesada 8"
8" widespread single lever sink mixer

Box: 1 | Carton: 6 | Pallet: 144



100001 05 45 | 68903 45 | 100088 45 | 100053 | 100098



J68

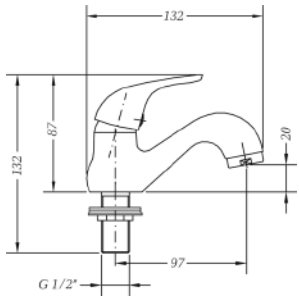

Ref.: 1007 04
Grifo lavabo 1 agua cartucho 25
One-water wash-basin tap 25 cartridge

Box: 1 | Carton: 32 | Pallet: 768



100085 45 | 100042 | 100098

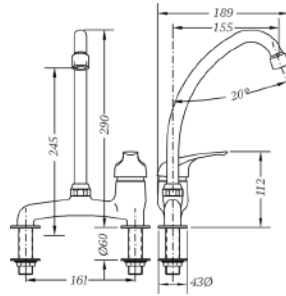

Ref.: 60199 05 45 66
Monomando mesada 6"
6" widespread single lever sink mixer

Box: 1 | Carton: 10 | Pallet: 240



100001 05 45 | 68903 45 | 100088 45 | 100053 | 100098



J68

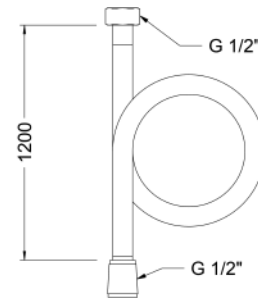

Ref.: 100141 45
Flexo H 1/2" - H 1/2", 1,20 m inoxidable
F 1/2" - F 1/2" Stainless steel flexible hose 1.20 m

Box: 1 | Carton: 50 | Pallet: 900

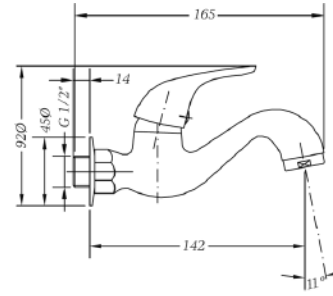

Ref.: 1006 04
Grifo lavabo mural 1 agua cartucho 25
One-water wall wash-basin tap 25 cartridge

Box: 1 | Carton: 36 | Pallet: 864



100085 45 | 100042

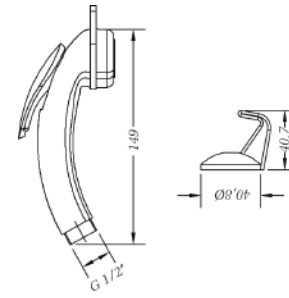

Ref.: 100696 45
Kit ducha sanitaria
Sanitary shower kit

Box: 1 | Carton: 100 | Pallet: 1800

serie New Regent Classic | Montura 1/4 vuelta cierre cerámico | Ceramic headwork quarter turn

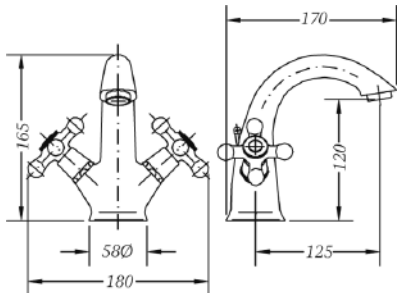

Ref.: 68506 09 45 66
Monobloc de lavabo cromo
Chromed wash-basin mixer

Box: 1 | Carton: 8 | Pallet: 144



68998 09 45 | 100085 45 | 68995 09 | 100103 | 100090

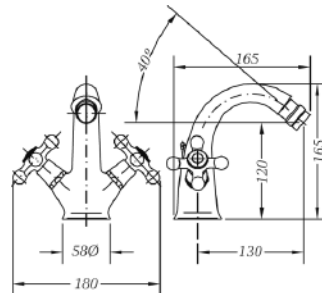

Ref.: 68516 09 45 66
Monobloc de bidé cromo
Chromed bidet mixer

Box: 1 | Carton: 8 | Pallet: 144



68998 09 45 | 100086 45 | 68995 09 | 100103 | 100090

serie New Regent Classic | Montura 1/4 vuelta cierre cerámico | Ceramic headwork quarter turn

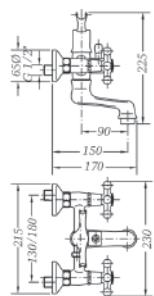

Ref.: 68526 09 45 66
Mezclador de baño cromo con kit
Chromed bath mixer with kit

Box: 1 | Carton: 4 | Pallet: 72



68998 09 45 | 100196 45 00 | 100135 60 00 | 1647 45



100083 45 | 68995 09 | 100125 45

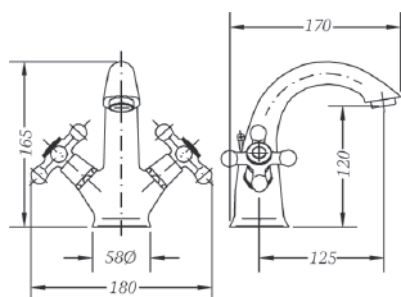

Ref.: 68506 09 43 66
Monobloc de lavabo bronce
Wash-basin mixer bronze

Box: 1 | Carton: 8 | Pallet: 144



68998 09 43 | 100085 43 | 68995 09 | 100103 | 100090

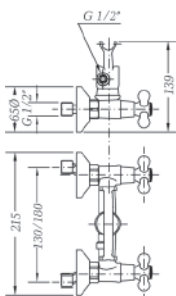

Ref.: 68531 09 45 66
Mezclador de ducha cromo con kit
Chromed shower mixer with kit

Box: 1 | Carton: 8 | Pallet: 96



68998 09 45 | 100196 45 00 | 100135 60 00 | 1647 45



68995 09 | 100125 45

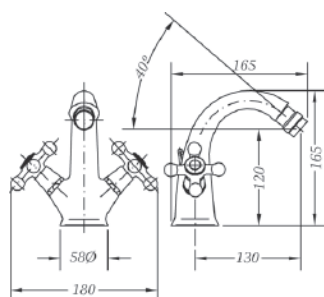

Ref.: 68516 09 43 66
Monobloc bidet bronce
Bronze bidet mixer

Box: 1 | Carton: 8 | Pallet: 144



68998 09 43 | 100086 43 | 68995 09 | 100103 | 100090

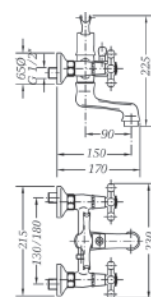

Ref.: 68526 09 43 66
Mezclador de baño bronce con kit
Bronze bath mixer with kit

Box: 1 | Carton: 4 | Pallet: 72



68998 09 43 | 100196 43 00 | 100135 43 00 | 1647 43



100083 43 | 68995 09 | 100125 43

serie New Regent Classic | Montura 1/4 vuelta cierre cerámico | Ceramic headwork quarter turn

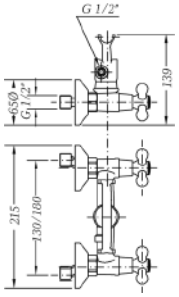

Ref.: 68531 09 43 66
 Mezclador de ducha bronce con kit
 Bronze shower mixer with kit

Box: 1 | Carton: 8 | Pallet: 96

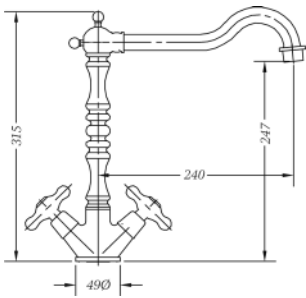
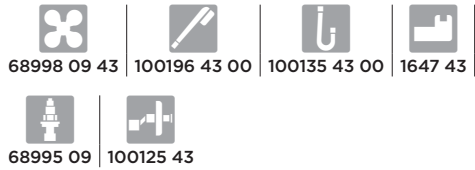

Ref.: 68595 09 43 66
 Monobloc de fregadera bronce
 Bronze sink mixer

Box: 1 | Carton: 4 | Pallet: 72

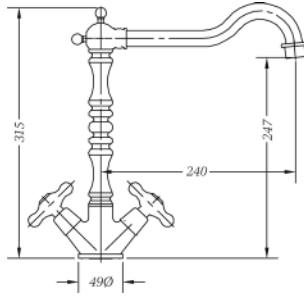
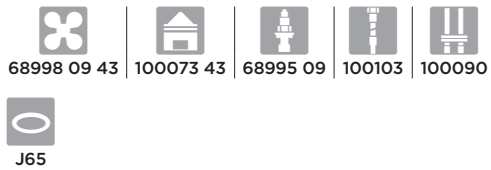

Ref.: 68595 09 45 66
 Monobloc de fregadera cromo
 Chromed sink mixer

Box: 1 | Carton: 4 | Pallet: 72

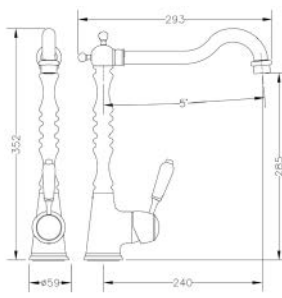
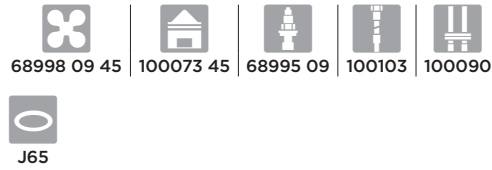

Ref.: 68201 39 45 66
 Monomando de fregadera cromo
 Chromed sink mixer

Box: 1 | Carton: 4 | Pallet: 96

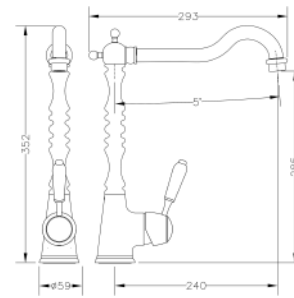
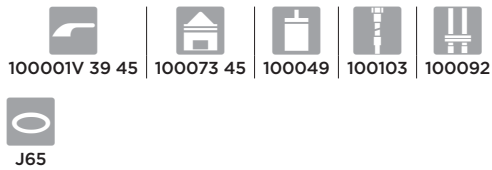

Ref.: 68201 39 43 66
 Monomando de fregadera bronce
 Bronze sink mixer

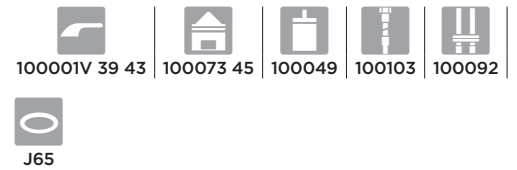

serie New Regent | Acabado cromado. Montura 1/4 vuelta cierre cerámico | Chromed finish. Ceramic headwork quarter turn

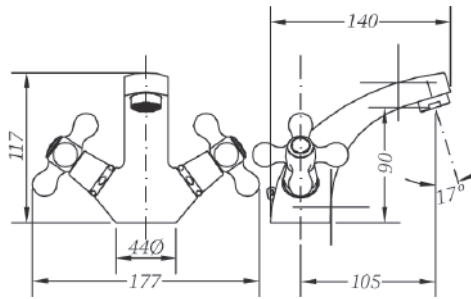

Ref.: 68505 09 45 66
Monobloc de lavabo
Wash-basin mixer

Box: 1 | Carton: 12 | Pallet: 216

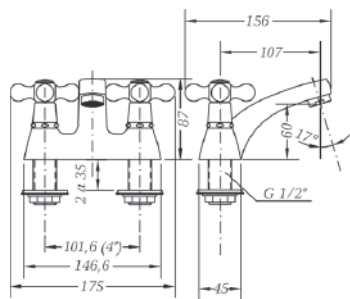
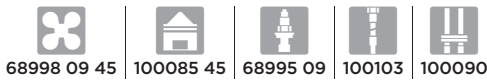

Ref.: 68511 09 45 66
Mezclador lavabo 4"
Wash-basin mixer 4"

Box: 1 | Carton: 12 | Pallet: 216

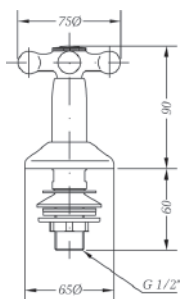

Ref.: 68520 09 45 66
Grifo bidé
Bidet tap

Box: 1 | Carton: 24 | Pallet: 576

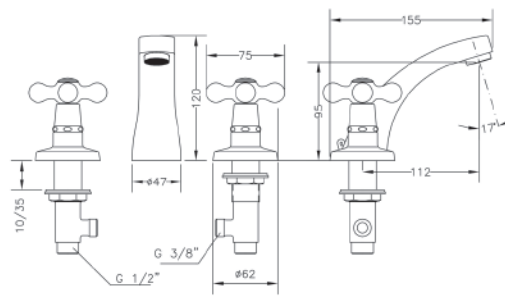

Ref.: 68510 09 45 66
Batería lavabo
Widespread wash-basin mixer

Box: 1 | Carton: 10 | Pallet: 240

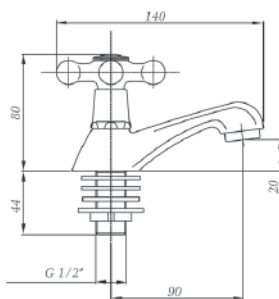

Ref.: 68500 09 45 66
Grifo lavabo
Wash-basin tap

Box: 1 | Carton: 24 | Pallet: 240

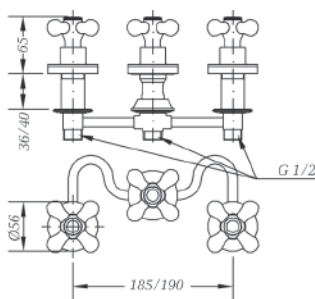

Ref.: 68142 09 45 66
Batería de bidé con transmisión
Widespread bidet mixed with transmission

Box: 1 | Carton: 10 | Pallet: 240

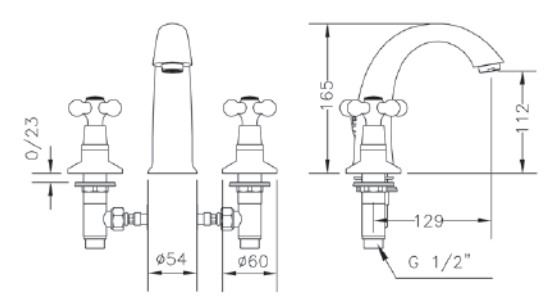

Ref.: 68120 09 45 66
Batería lavabo
Widespread wash-basin mixer

Box: 1 | Carton: 6 | Pallet: 240

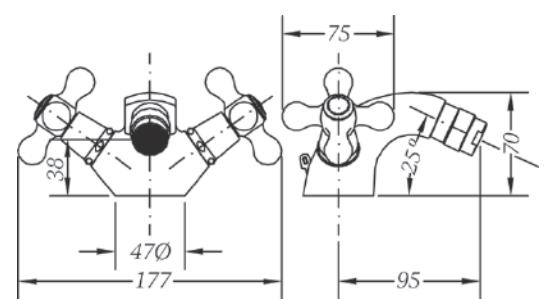

Ref.: 68515 09 45 66
Monobloc de bidé
Bidet mixer

Box: 1 | Carton: 12 | Pallet: 216

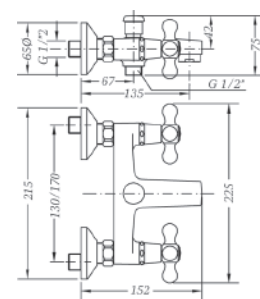
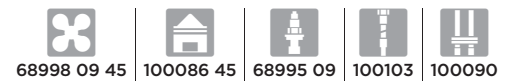

Ref.: 68525 09 45 66
Mezclador de baño con kit
Bath mixer with kit

Box: 1 | Carton: 12 | Pallet: 216



serie New Regent | Acabado cromado. Montura 1/4 vuelta cierre cerámico | Chromed finish. Ceramic headwork quarter turn

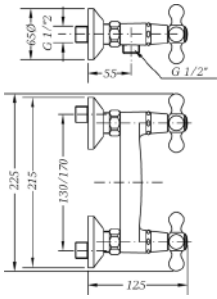

Ref.: 68530 09 45 66
Mezclador de ducha con kit
Shower mixer with kit

Box: 1 | Carton: 12 | Pallet: 216

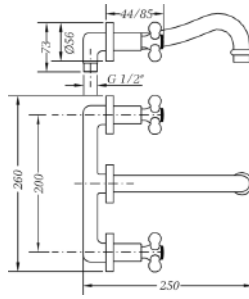

Ref.: 68131 09 45 66
Grupo de lavabo empotrado
Built-in wash-basin mixer

Box: 1 | Carton: 10 | Pallet: 240

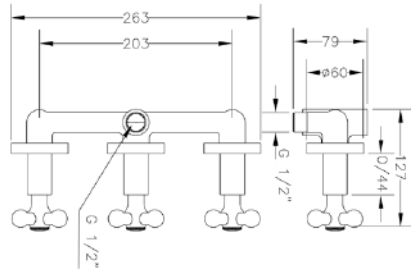

Ref.: 68527 09 45 66
Grupo baño empotrado 8" con inversor
Built-in 8" bath mixer with diverter

Box: 1 | Carton: 10 | Pallet: 240

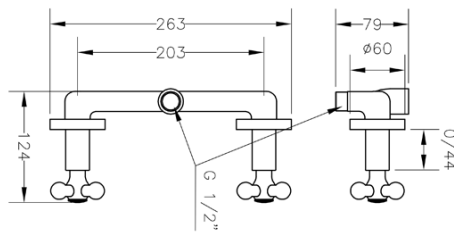

Ref.: 68535 09 45 66
Grupo ducha empotrado 8"
Built-in 8" shower mixer

Box: 1 | Carton: 10 | Pallet: 240

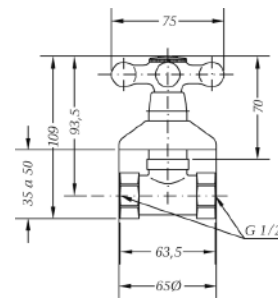

Ref.: 68590 09 45 66
Llave de paso 1/2"
Stopcock 1/2"

Box: 1 | Carton: 24 | Pallet: 240

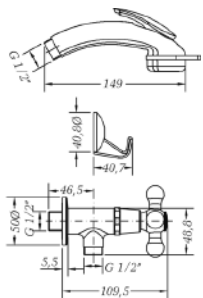

Ref.: 68001 09 45 66
Grifo de bidé con teleducha
Bidet tap with shower

Box: 1 | Carton: 20 | Pallet: 360

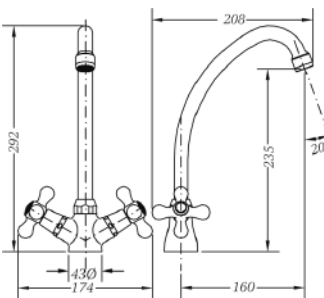

Ref.: 68540 09 45 66
Monobloc fregadera caño tubo
Sink mixer, swan neck spout

Box: 1 | Carton: 10 | Pallet: 240

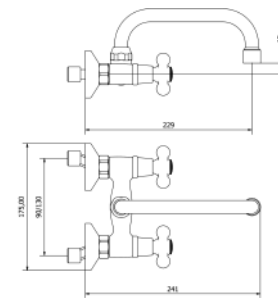

Ref.: 68550 09 45 66
Grupo mural fregadera 11 cm caño tubo alto 18 cm
Wall sink mixer with 11 cm high tube, 18 cm spout

Box: 1 | Carton: 10 | Pallet: 240



serie New Regent | Acabado cromado. Montura 1/4 vuelta cierre cerámico | Chromed finish. Ceramic headwork quarter turn

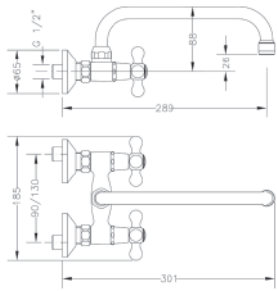

Ref.: 68196 09 45 66

Grupo mural fregadera 11 cm caño tubo alto 24 cm
Wall sink mixer with 11cm high tube, 24 cm spout

Box: 1 | Carton: 10 | Pallet: 270

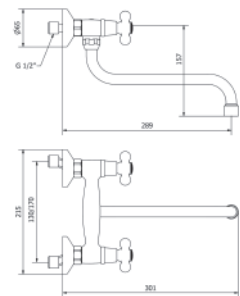

Ref.: 68560 09 45 66

Grupo mural fregadera 15 cm caño tubo bajo 24 cm
Wall sink mixer with 15cm low tube, 24 cm spout

Box: 1 | Carton: 10 | Pallet: 240

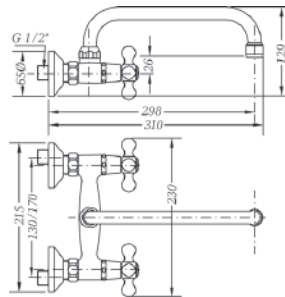

Ref.: 68555 09 45 66

Grupo mural fregadera 15 cm caño tubo alto 24 cm
Wall sink mixer with 15 cm with high tube, 24 cm spout

Box: 1 | Carton: 10 | Pallet: 240

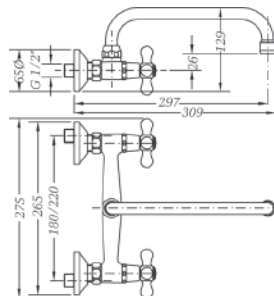

Ref.: 68565 09 45 66

Grupo mural fregadera 20 cm caño tubo alto 24 cm
20 cm wall sink mixer with high tube, 24 cm spout

Box: 1 | Carton: 10 | Pallet: 240

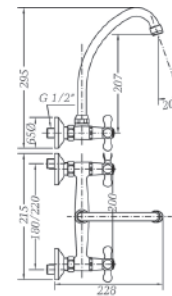

Ref.: 68570 09 45 66

Grupo mural fregadera 20 cm caño tubo alto vertical
20 cm wall sink mixer with swan neck spout

Box: 1 | Carton: 10 | Pallet: 240



serie New Regent | Acabado cromado. Montura 1/4 vuelta cierre cerámico | Chromed finish. Ceramic headwork quarter turn

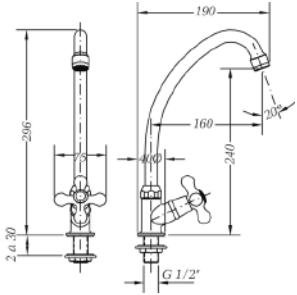

Ref.: 68585 09 45 66

Grifo fregadera encimera caño tubo vertical
Deck sink tap with swan neck spout

Box: 1 | Carton: 10 | Pallet: 240



68998 09 45 | 68903 45 | 100088 45 | 68995 09 | 100098



J68

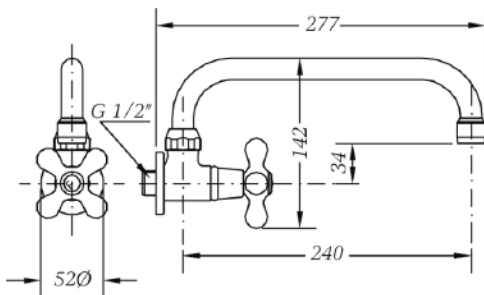

Ref.: 68580 09 45 66

Grifo mural fregadera caño tubo alto 24 cm
Wall sink tap with tube spout 24 cm

Box: 1 | Carton: 10 | Pallet: 240



68998 09 45 | 68902 45 | 100088 45 | 68995 09 | J68

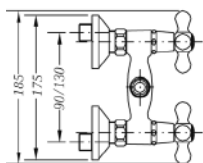
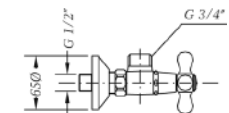

Ref.: 568550 45

Cuerpo grupo mural 11 cm
Wall body mixer 11 cm

Box: 1 | Carton: 15 | Pallet: 360



68998 09 45 | 68995 09 | 100125 45

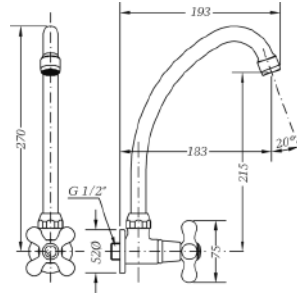

Ref.: 68575 09 45 66

Grifo fregadera mural caño tubo vertical
Wall sink tap with swan neck spout

Box: 1 | Carton: 10 | Pallet: 240



68998 09 45 | 68903 45 | 100088 45 | 68995 09 | J68



J68

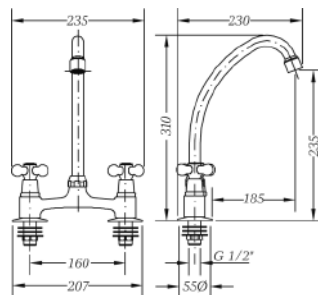

Ref.: 68194 09 45 66

Mezclador mesada 6" caño tubo
6" deck mixer with swan neck spout

Box: 1 | Carton: 10 | Pallet: 240



68998 09 45 | 68903 45 | 100088 45 | 68995 09 | 100098



J68

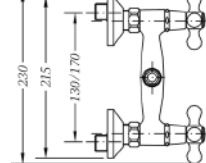
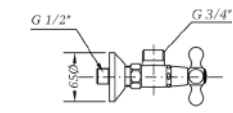

Ref.: 568555 45

Cuerpo grupo mural 15 cm
Wall body mixer 15 cm

Box: 1 | Carton: 15 | Pallet: 360



68998 09 45 | 68995 09 | 100125 45

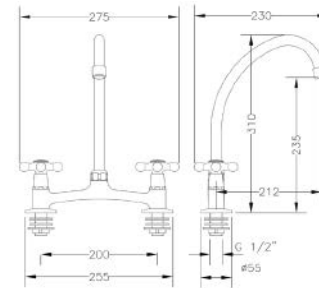

Ref.: 68545 09 45 66

Mezclador mesada 8" caño tubo
8" deck mixer with swan neck spout

Box: 1 | Carton: 10 | Pallet: 240



68998 09 45 | 68903 45 | 100088 45 | 68995 09 | 100098



J68

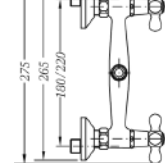
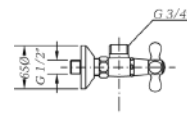

Ref.: 568565 45

Cuerpo grupo mural 20 cm
Wall body mixer 20 cm

Box: 1 | Carton: 15 | Pallet: 360



68998 09 45 | 68995 09 | 100125 45

serie New Regent | Acabado cromado. Montura 1/4 vuelta cierre cerámico | Chromed finish. Ceramic headwork quarter turn

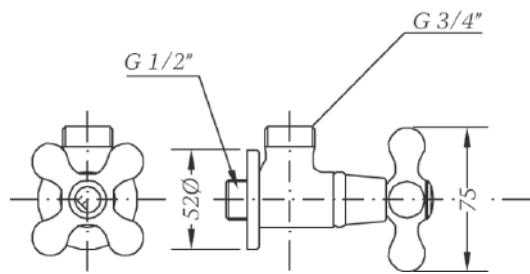

Ref.: 568575 45
Cuerpo grifo mural
Wall body tap

Box: 1 | Carton: 30 | Pallet: 540

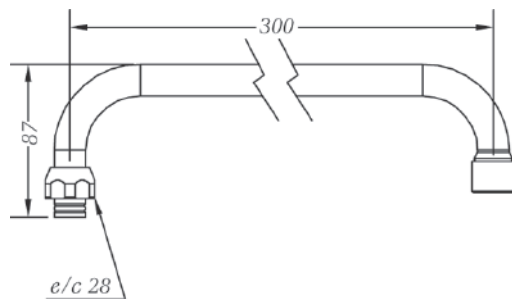

Ref.: 68908 45
Caño alto tubo 30 cm
High tube spout 30 cm

Box: 1 | Carton: 40 | Pallet: 720

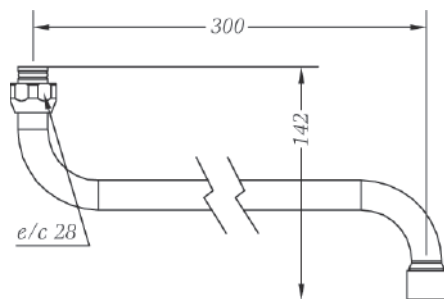

Ref.: 68909 45
Caño bajo tubo 30 cm
Low tube spout 30 cm

Box: 1 | Carton: 40 | Pallet: 720

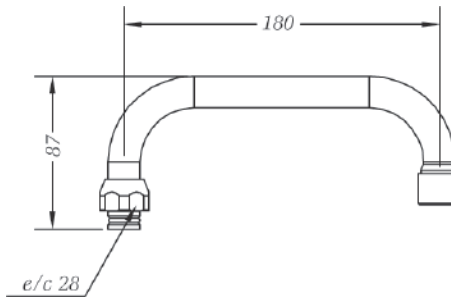

Ref.: 68901 45
Caño alto tubo 18 cm
High tube spout 18 cm

Box: 1 | Carton: 40 | Pallet: 720

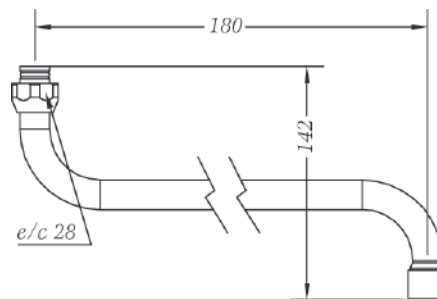

Ref.: 68910 45
Caño bajo tubo 18 cm
Low tube spout 18 cm

Box: 1 | Carton: 40 | Pallet: 720

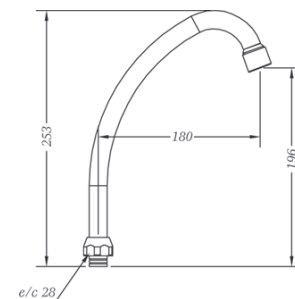

Ref.: 68903 45
Caño tubo vertical
Swan neck spout

Box: 1 | Carton: 30 | Pallet: 540

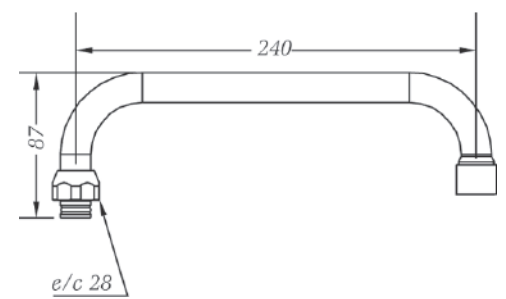

Ref.: 68902 45
Caño alto tubo 24 cm
High tube spout 24 cm

Box: 1 | Carton: 30 | Pallet: 540

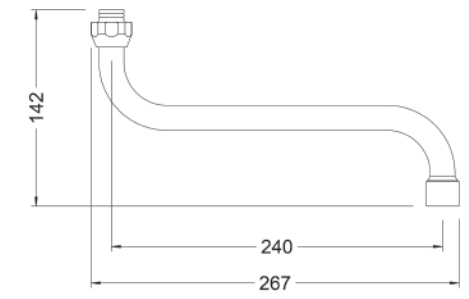

Ref.: 68904 45
Caño bajo tubo 24 cm
Low tube spout 24 cm

Box: 1 | Carton: 30 | Pallet: 540



serie Gamma | Acabado cromado. Montura convencional | Chromed finish. Conventional headwork

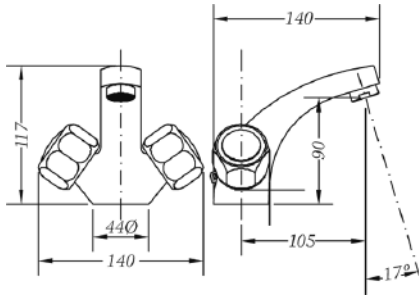

Ref.: 68130 11 45 66
Monobloc de lavabo
Wash-basin mixer

Box: 1 | Carton: 12 | Pallet: 216

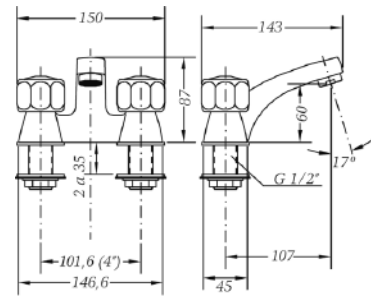

Ref.: 68122 11 45 66
Mezclador lavabo 4"
Wash-basin mixer 4"

Box: 1 | Carton: 12 | Pallet: 216

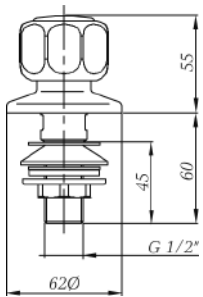
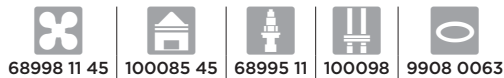

Ref.: 68160 11 45 66
Grifo bidé
Bidet tap

Box: 1 | Carton: 24 | Pallet: 576

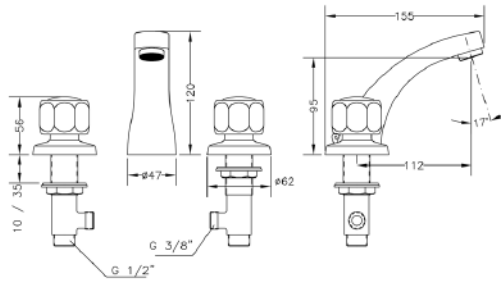

Ref.: 68120 11 45 66
Bateria de lavabo
Widespread wash-basin mixer

Box: 1 | Carton: 10 | Pallet: 240

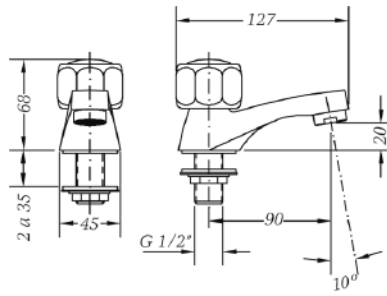
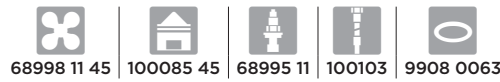

Ref.: 68180 11 45 66
Grifo de lavabo
Wash-basin tap

Box: 1 | Carton: 24 | Pallet: 576

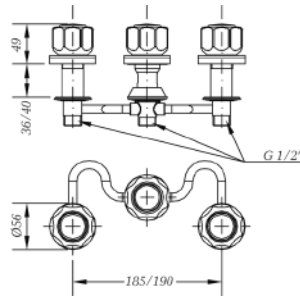

Ref.: 68142 11 45 66
Bateria de bidé con transmisión
Widespread bidet mixer with transmission

Box: 1 | Carton: 10 | Pallet: 240

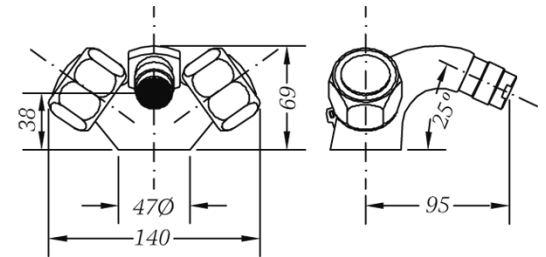

Ref.: 68140 11 45 66
Monobloc de bidé
Bidet mixer

Box: 1 | Carton: 12 | Pallet: 216



serie Gamma | Acabado cromado. Montura convencional | Chromed finish. Conventional headwork

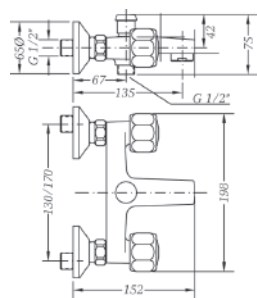

Ref.: 68100 11 45 66
Mezclador de baño con kit
Bath mixer with kit

Box: 1 | Carton: 12 | Pallet: 216

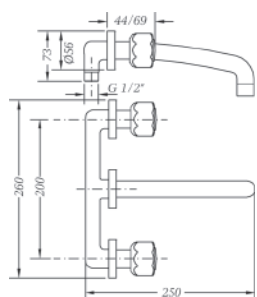

Ref.: 68131 11 45 66
Grupo de lavabo empotrado
Built-in wash-basin

Box: 1 | Carton: 10 | Pallet: 240

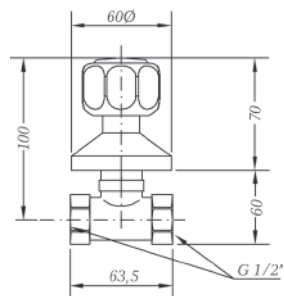

Ref.: 68170 11 45 66
Llave de paso 1/2"
Stopcock 1/2"

Box: 1 | Carton: 24 | Pallet: 576

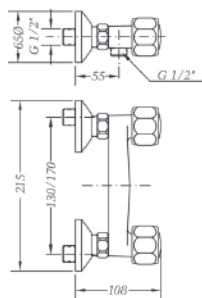

Ref.: 68110 11 45 66
Mezclador de ducha con kit
Shower mixer with kit

Box: 1 | Carton: 12 | Pallet: 216

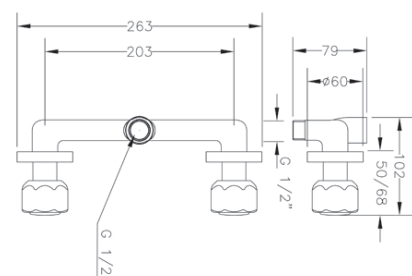

Ref.: 68115 11 45 66
Grupo ducha empotrado 8"
Built-in 8" shower mixer

Box: 1 | Carton: 10 | Pallet: 240

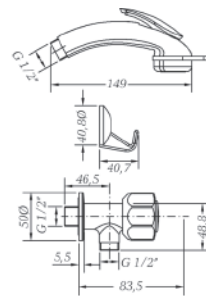

Ref.: 68001 11 45 66
Grifo de bidé con teleducha
Bidet tap with shower

Box: 1 | Carton: 20 | Pallet: 360

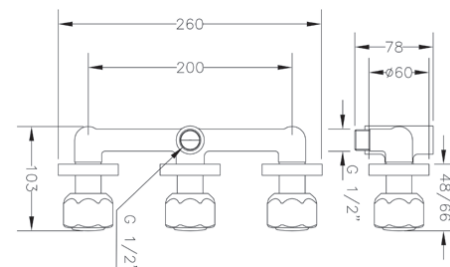

Ref.: 68116 11 45 66
Grupo baño empotrado 8" con inversor
Built-in 8" bath mixer with diverter

Box: 1 | Carton: 10 | Pallet: 240

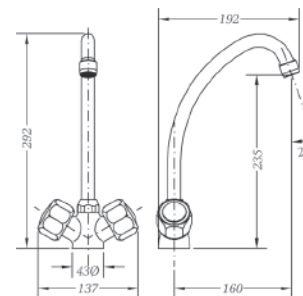

Ref.: 68200 11 45 66
Monobloc de fregadera caño tubo
Sink mixer, swan neck spout

Box: 1 | Carton: 10 | Pallet: 240



serie Gamma | Acabado cromado. Montura convencional | Chromed finish. Conventional headwork

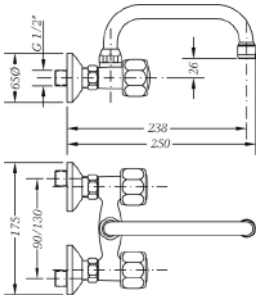

Ref.: 68195 11 45 66

Grupo mural fregadera 11 cm caño tubo alto 18 cm
Wall sink mixer with 11cm high tube, 18 cm spout

Box: 1 | Carton: 10 | Pallet: 240

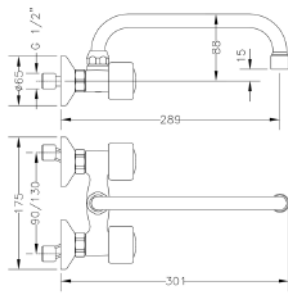

Ref.: 68196 11 45 66

Grupo mural fregadera 11 cm caño tubo alto 24 cm
Wall sink mixer with 11 cm, high tube 24 cm spout

Box: 1 | Carton: 10 | Pallet: 270

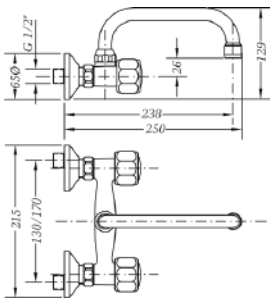

Ref.: 68190 11 45 66

Grupo mural fregadera 15 cm caño tubo alto 18 cm
Wall sink mixer with 15 cm, high tube, 18 cm spout

Box: 1 | Carton: 10 | Pallet: 240

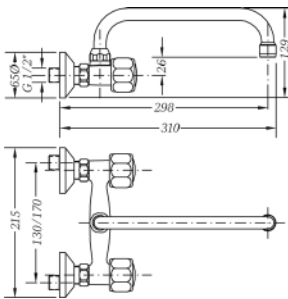

Ref.: 68193 11 45 66

Grupo mural fregadera 15 cm caño tubo alto 24 cm
Wall sink mixer with 15 cm with high tube, 24 cm spout

Box: 1 | Carton: 10 | Pallet: 240

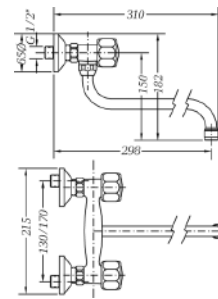

Ref.: 68197 11 45 66

Grupo mural fregadera 15 cm caño tubo bajo 24 cm
Wall sink mixer with 15cm low tube, 24 cm spout

Box: 1 | Carton: 10 | Pallet: 240



serie Gamma | Acabado cromado. Montura convencional | Chromed finish. Conventional headwork

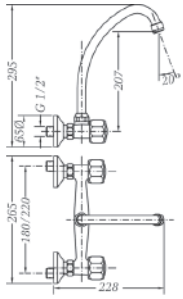

Ref.: 68103 11 45 66

Grupo mural fregadera 20 cm caño tubo alto vertical
20 cm wall sink mixer with swan neck spout

Box: 1 | Carton: 10 | Pallet: 240



68998 11 45



68903 45



100088 45



68995 11



100125 45



J68



9908 0063

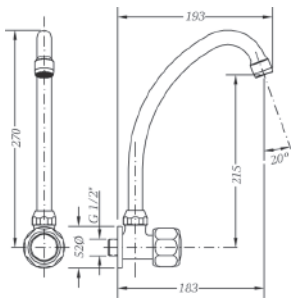

Ref.: 68083 11 45 66

Grifo fregadera mural caño tubo vertical
Wall sink tap with swan neck spout

Box: 1 | Carton: 10 | Pallet: 240



68998 11 45



68903 45



100088 45



68995 11



J68



9908 0063

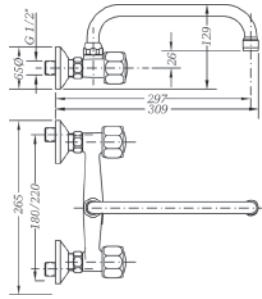

Ref.: 68104 11 45 66

Grupo mural fregadera 20 cm caño tubo alto 24 cm
20 cm wall sink mixer with high tube, 24 cm spout

Box: 1 | Carton: 10 | Pallet: 240



68998 11 45



68902 45



100088 45



68995 11



100125 45



J68



9908 0063

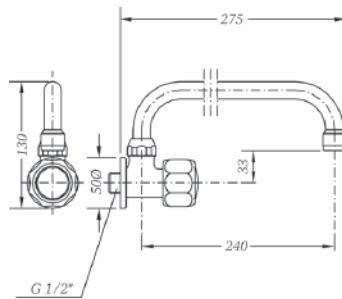

Ref.: 68093 11 45 66

Grifo mural fregadera caño tubo alto 24 cm
Wall sink tap with tube spout 24 cm

Box: 1 | Carton: 10 | Pallet: 240



68998 11 45



68902 45



100088 45



68995 11



J68



9908 0063

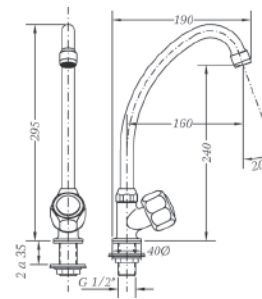

Ref.: 68003 11 45 66

Grifo fregadera encimera caño tubo vertical
Deck sink tap with swan neck spout

Box: 1 | Carton: 10 | Pallet: 240



68998 11 45



68903 45



100088 45



68995 11



100098



J68



9908 0063

serie Gamma | Acabado cromado. Montura convencional | Chromed finish. Conventional headwork

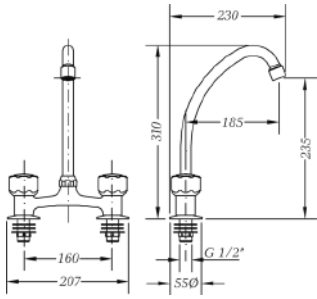

Ref.: 68194 11 45 66
Mezclador mesada 6" caño tubo
6" deck mixer with swan neck spout

Box: 1 | Carton: 10 | Pallet: 240



68998 11 45 | 68903 45 | 100088 45 | 68995 11 | 100098

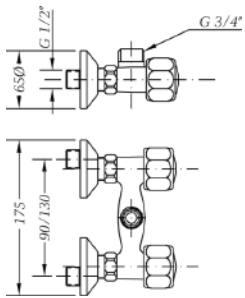

Ref.: 568195 45
Cuerpo grupo mural 11 cm
Wall body mixer 11 cm

Box: 1 | Carton: 20 | Pallet: 480



68998 11 45 | 68995 11 | 100125 45 | 9908 0063

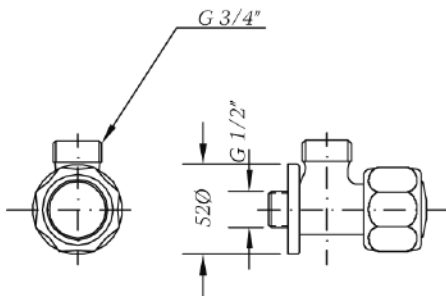

Ref.: 568083 45
Cuerpo grifo mural
Wall body tap

Box: 1 | Carton: 40 | Pallet: 960



68998 11 45 | 68995 11 | 9908 0063

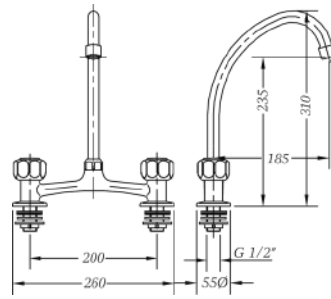

Ref.: 68199 11 45 66
Mezclador mesada 8" caño tubo
8" deck mixer with swan neck spout

Box: 1 | Carton: 10 | Pallet: 240



68998 11 45 | 68903 45 | 100088 45 | 68995 11 | 100098

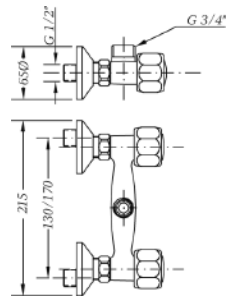

Ref.: 568193 45
Cuerpo grupo mural 15 cm
Wall body mixer 15 cm

Box: 1 | Carton: 20 | Pallet: 480



68998 11 45 | 68995 11 | 100125 45 | 9908 0063

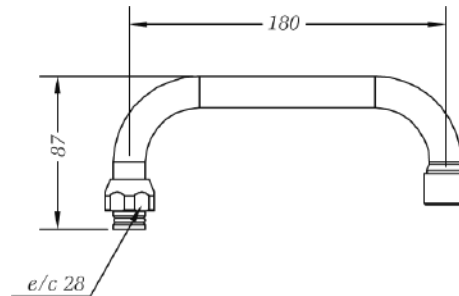

Ref.: 68901 45
Caño alto tubo 18 cm
High tube spout 18 cm

Box: 1 | Carton: 40 | Pallet: 720



100088 45 | J68

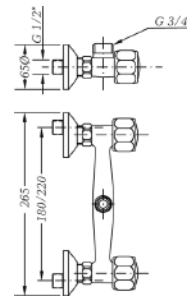

Ref.: 568104 45
Cuerpo grupo mural 20 cm
Wall body mixer 20 cm

Box: 1 | Carton: 15 | Pallet: 360



68998 11 45 | 68995 11 | 100125 45 | 9908 0063

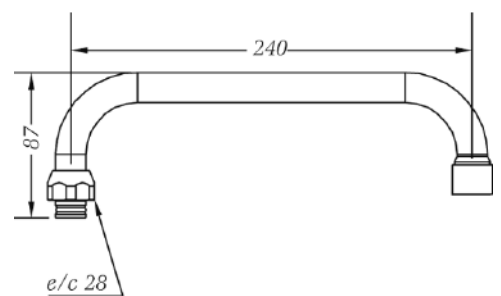

Ref.: 68902 45
Caño alto tubo 24 cm
High tube spout 24 cm

Box: 1 | Carton: 30 | Pallet: 540



100088 45 | J68

serie Gamma | Acabado cromado. Montura convencional | Chromed finish. Conventional headwork

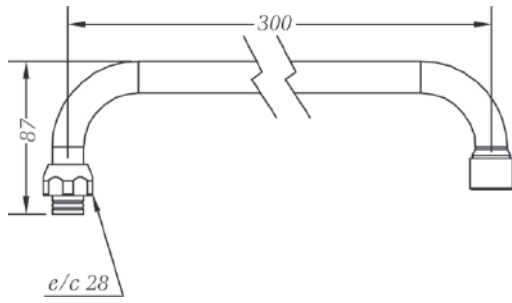

Ref.: 68908 45
Caño alto tubo 30 cm
High tube spout 30 cm

Box: 1 | Carton: 40 | Pallet: 720



100088 45 | J68

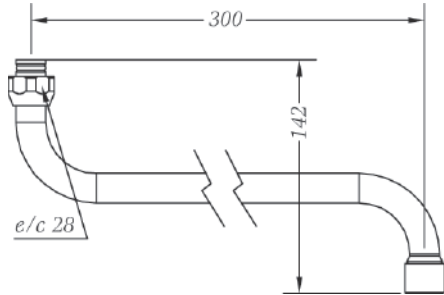

Ref.: 68909 45
Caño bajo tubo 30 cm
Low tube spout 30 cm

Box: 1 | Carton: 40 | Pallet: 720



100088 45 | J68

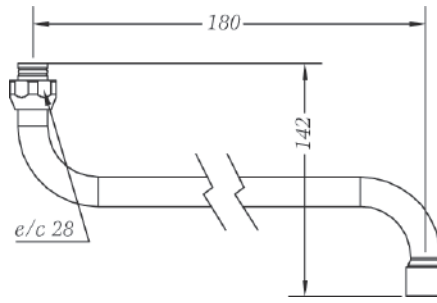

Ref.: 68910 45
Caño bajo tubo 18 cm
Low tube spout 18 cm

Box: 1 | Carton: 40 | Pallet: 720



100088 45 | J68

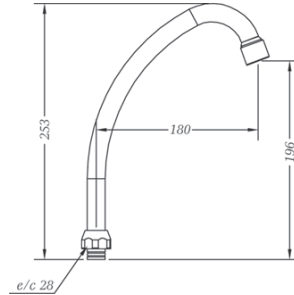

Ref.: 68903 45
Caño tubo vertical
Swan neck spout

Box: 1 | Carton: 30 | Pallet: 540



100088 45 | J68

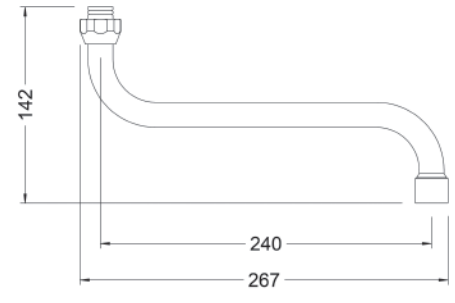

Ref.: 68904 45
Caño bajo tubo 24 cm
Low tube spout 24 cm

Box: 1 | Carton: 30 | Pallet: 540



100088 45 | J68

serie Kalo | Acabado cromado. Montura 1/4 vuelta cierre cerámico | Ceramic headwork quarter turn

Las series Kalo, Kross y Ixo nacen de la combinación de diferentes componentes: cuerpos, caños y volantes. Busque la combinación que mejor se adapte a su baño.

Puede pedirla utilizando la referencia de catálogo o individualmente por componente.

En este apartado podrá identificar fácilmente las referencias de cada componente necesario.



The Kalo, Kross and Ixo series are born from the combination of different components: bodies, pipes and handles. Look for the combination that best suits your bathroom.

You can order it using the catalog reference or individually for each component.

In this section you can easily identify the references of each required component.

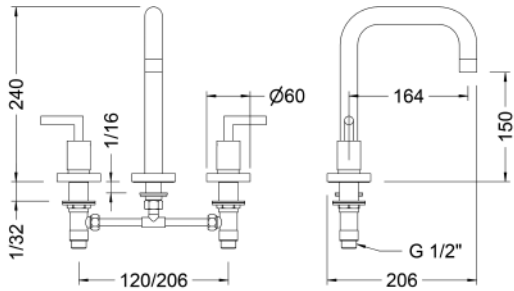

Ref.: 68120 07 45 66

Batería de lavabo caño recto
Widespread wash-basin mixer with straight pipe spout

Box: 1

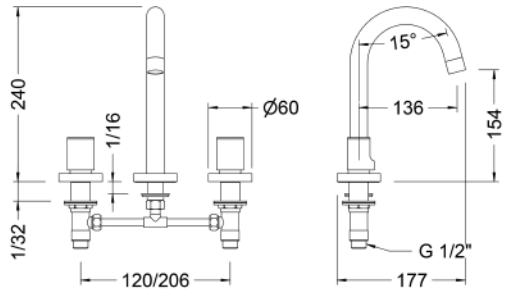
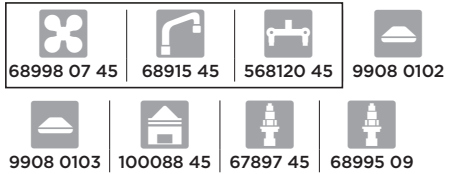

Ref.: 68124 07 45 66

Batería de lavabo caño cisne
Widespread wash-basin mixer with swan pipe spout

Box: 1

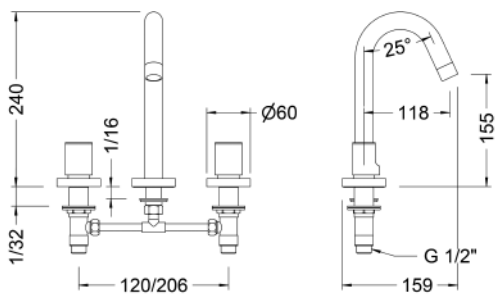

Ref.: 68125 07 45 66

Batería de lavabo caño inclinado
Widespread wash-basin mixer with sloping pipe spout

Box: 1

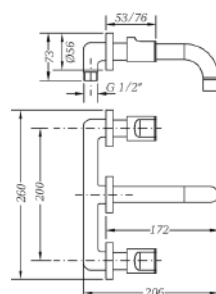
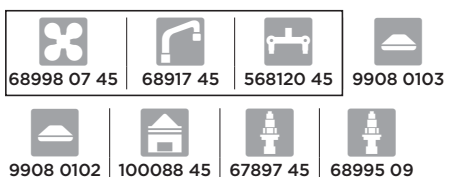

Ref.: 68131 07 45 66

Grupo de lavabo empotrado caño 16 cm
Built-in wash-basin mixer with 16 cm pipe spout

Box: 1

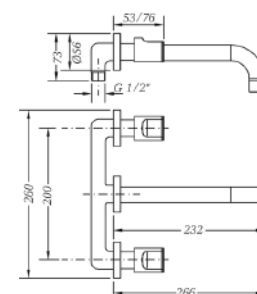
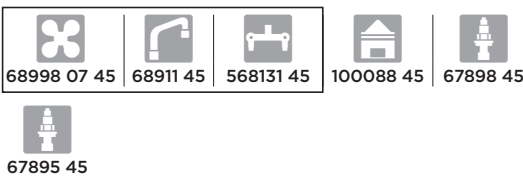

Ref.: 68132 07 45 66

Grupo de lavabo empotrado caño 22 cm
Built-in wash-basin with 22 cm pipe spout

Box: 1

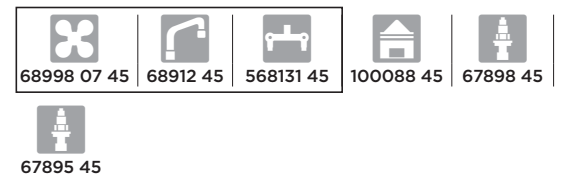

serie Kalo | Acabado cromado. Montura 1/4 vuelta cierre cerámico | Ceramic headwork quarter turn

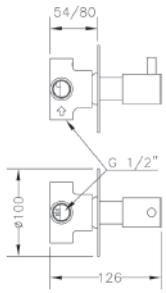

Ref.: 63114 30 45 66
 Inversor cerámico 3 vías empotrado placa redonda
 Built-in 3 way ceramic diverter with round plate
Box: 1

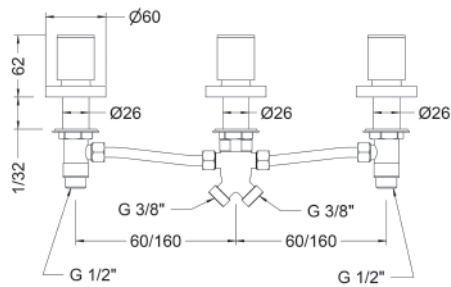

Ref.: 68113 07 45 66
 Batería de baño con inversor
 Widespread bath mixer with diverter

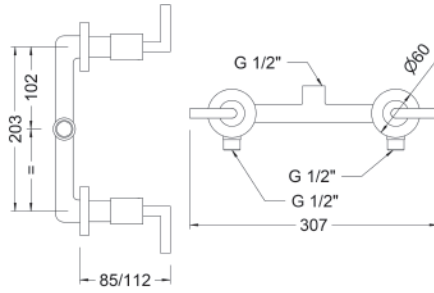
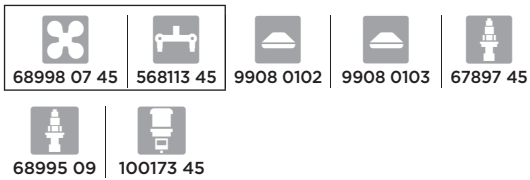

Ref.: 68115 07 45 66
 Grupo ducha empotrado 8"
 Built-in 8" shower mixer

Box: 1

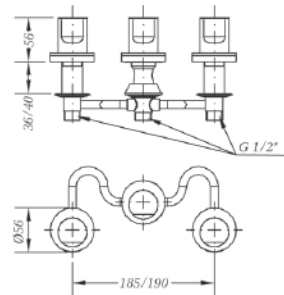

Ref.: 68142 07 45 66
 Batería de bidé con transmisión
 Widespread bidet mixer with transmission

Box: 1

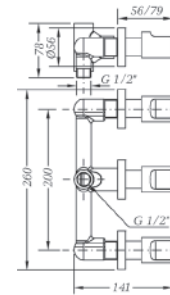
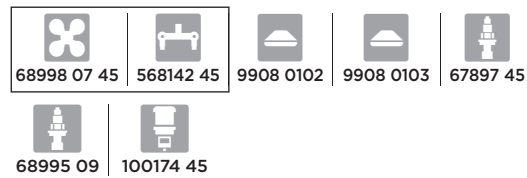

Ref.: 68116 07 45 66
 Grupo baño empotrado 8" con inversor
 Built-in 8" bath mixer with diverter

Box: 1

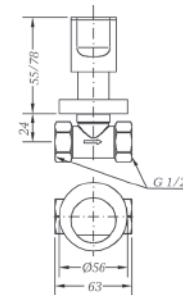

Ref.: 68170 07 45 66
 Llave de paso 1/2"
 Stopcock 1/2"

Box: 1

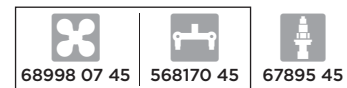

serie Kross | Acabado cromado. Montura 1/4 vuelta cierre cerámico | Chromed finish. Ceramic headwork quarter turn

Las series Kalo, Kross y Ixo nacen de la combinación de diferentes componentes: cuerpos, caños y volantes. Busque la combinación que mejor se adapte a su baño.

Puede pedirla utilizando la referencia de catálogo o individualmente por componente.

En este apartado podrá identificar fácilmente las referencias de cada componente necesario.



The Kalo, Kross and Ixo series are born from the combination of different components: bodies, pipes and handles. Look for the combination that best suits your bathroom.

You can order it using the catalog reference or individually for each component.

In this section you can easily identify the references of each required component.

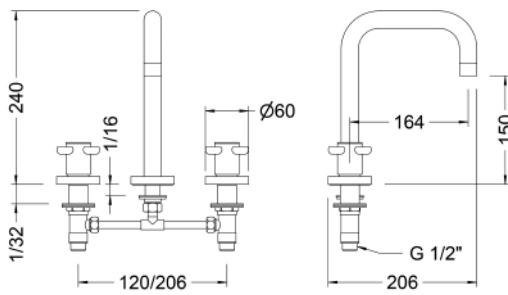

Ref.: 68120 08 45 66

Batería de lavabo caño recto
Widespread wash-basin mixer with straight pipe spout

Box: 1

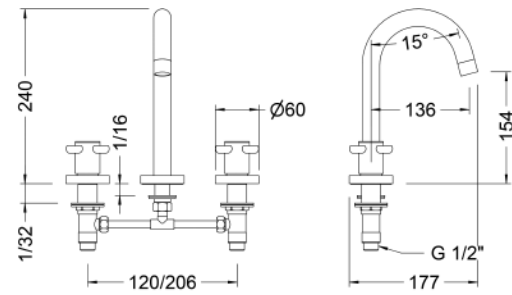

Ref.: 68124 08 45 66

Batería de lavabo caño cisne
Widespread wash-basin mixer with swan pipe spout

Box: 1

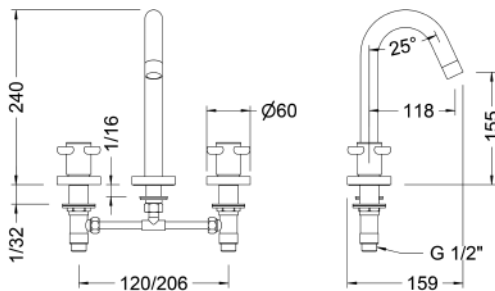

Ref.: 68125 08 45 66

Batería de lavabo caño inclinado
Widespread wash-basin mixer with sloping pipe spout

Box: 1

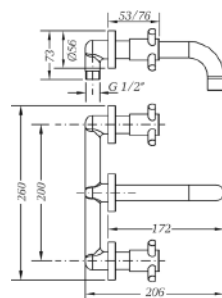

Ref.: 68131 08 45 66

Grupo de lavabo empotrado caño 16 cm
Built-in wash-basin mixer with 16 cm pipe spout

Box: 1

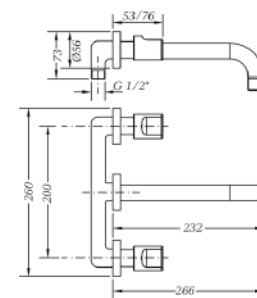

Ref.: 68132 08 45 66

Grupo de lavabo empotrado caño 22 cm
Built-in wash-basin mixer with 22cm pipe spout

Box: 1



serie Kross | Acabado cromado. Montura 1/4 vuelta cierre cerámico | Chromed finish. Ceramic headwork quarter turn

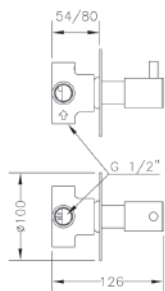

Ref.: 63114 30 45 66
 Inversor cerámico 3 vías empotrado placa redonda
 Built-in 3 way ceramic diverter with round plate

Box: 1



68998 30 45 | 9908 0025 | PR113

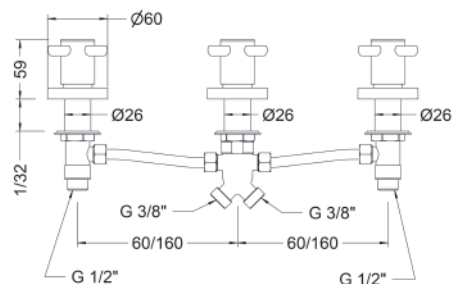

Ref.: 68113 08 45 66
 Batería de baño con inversor
 Widespread bath mixer with diverter



68998 08 45 | 568113 45 | 9908 0102 | 9908 0103 | 67897 45



68995 09 | 100173 45

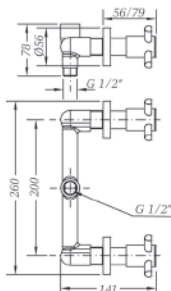

Ref.: 68115 08 45 66
 Grupo ducha empotrado 8"
 Built-in 8" shower mixer

Box: 1

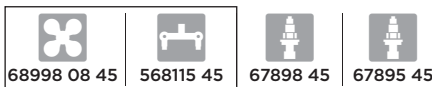

68998 08 45 | 568115 45 | 67898 45 | 67895 45

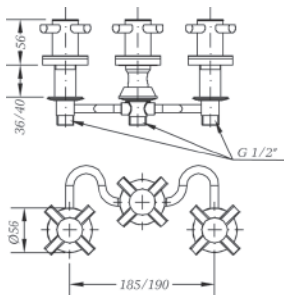

Ref.: 68142 08 45 66
 Batería de bidé con transmisión
 Widespread bidet mixer with transmission

Box: 1



68998 08 45 | 568142 45 | 9908 0102 | 9908 0103 | 67897 45



68995 09 | 100174 45

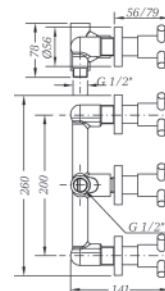

Ref.: 68116 08 45 66
 Grupo ducha empotrado 8" con inversor
 Built-in 8" bath mixer with diverter

Box: 1



68998 08 45 | 568116 45 | 67898 45 | 67895 45 | 100173 45

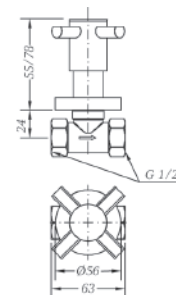

Ref.: 68170 08 45 66
 Llave de paso 1/2"
 Stopcock 1/2"

Box: 1

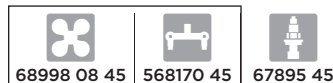

68998 08 45 | 568170 45 | 67895 45

serie Ixo | Acabado cromado. Montura 1/4 vuelta cierre cerámico | Chromed finish. Ceramic headwork quarter turn

Las series Kalo, Kross y Ixo nacen de la combinación de diferentes componentes: cuerpos, caños y volantes. Busque la combinación que mejor se adapte a su baño.

Puede pedirla utilizando la referencia de catálogo o individualmente por componente.

En este apartado podrá identificar fácilmente las referencias de cada componente necesario.



The Kalo, Kross and Ixo series are born from the combination of different components: bodies, pipes and handles. Look for the combination that best suits your bathroom.

You can order it using the catalog reference or individually for each component.

In this section you can easily identify the references of each required component.

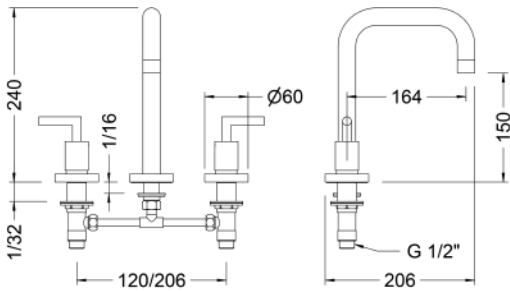

Ref.: 68120 12 45 66

Batería de lavabo caño recto
Widespread wash-basin mixer with straight pipe spout

Box: 1

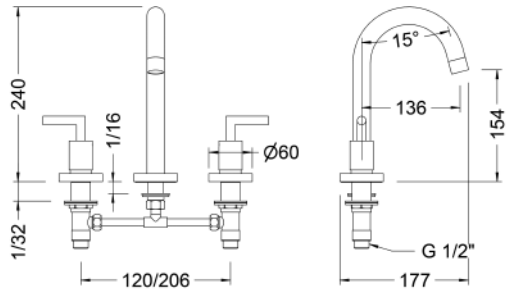
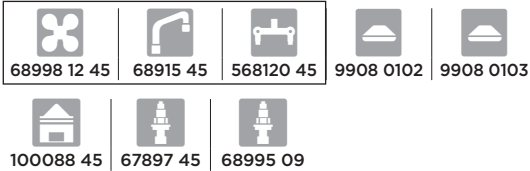

Ref.: 68124 12 45 66

Batería de lavabo caño cisne
Widespread wash-basin mixer with swan pipe spout

Box: 1

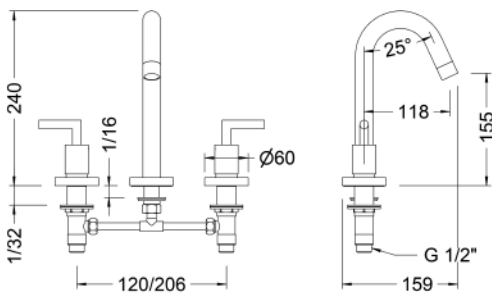
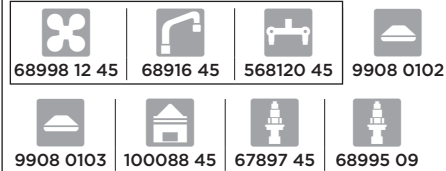

Ref.: 68125 12 45 66

Batería de lavabo caño inclinado
Widespread wash-basin mixer with sloping pipe spout

Box: 1

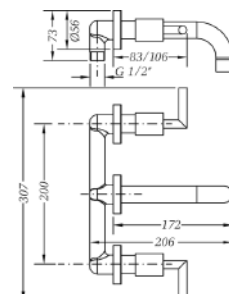
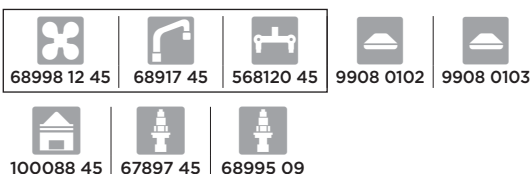

Ref.: 68131 12 45 66

Grupo de lavabo empotrado caño 16 cm
Built-in wash-basin mixer with 16 cm pipe spout

Box: 1

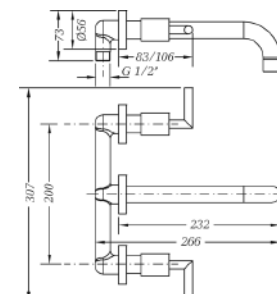
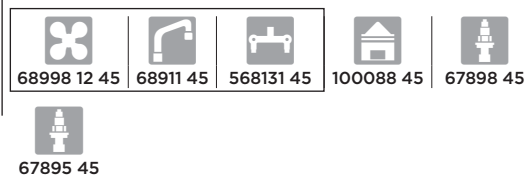

Ref.: 68132 12 45 66

Grupo de lavabo empotrado caño 22 cm
Built-in wash-basin mixer with 22 cm pipe spout

Box: 1

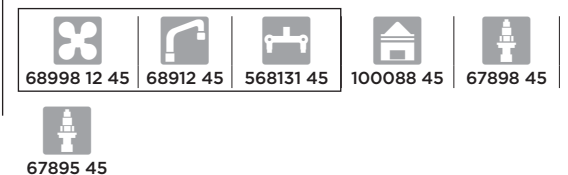

serie Ixo | Acabado cromado. Montura 1/4 vuelta cierre cerámico | Chromed finish. Ceramic headwork quarter turn

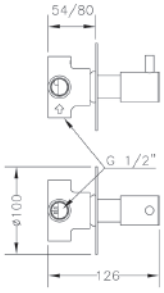

Ref.: 63114 30 45 66
 Inversor cerámico 3 vías empotrado placa redonda
 Built-in 3 way ceramic diverter with round plate
Box: 1

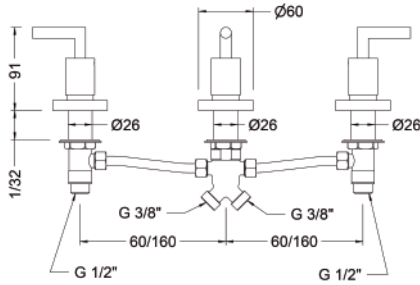

Ref.: 68113 12 45 66
 Batería de baño con inversor
 Widespread bath mixer with diverter

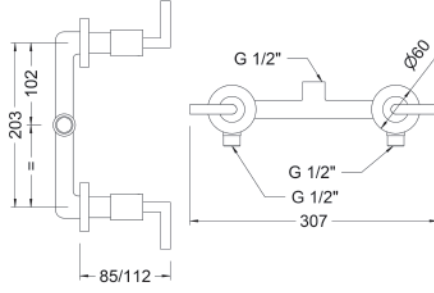
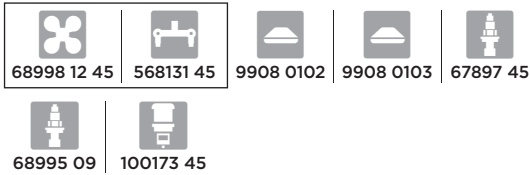

Ref.: 68115 12 45 66
 Grupo ducha empotrado 8\"/>

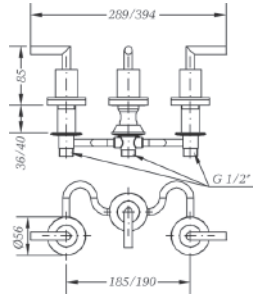

Ref.: 68142 12 45 66
 Batería de bidé con transmisión
 Widespread bidet mixer with transmission

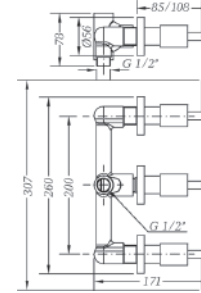
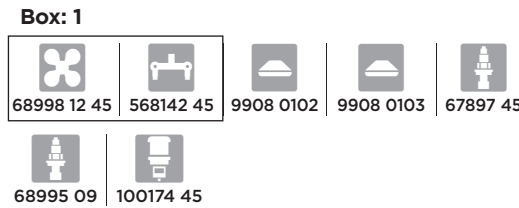

Ref.: 68116 12 45 66
 Grupo ducha empotrado 8\"/>

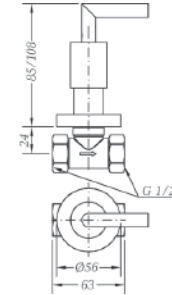
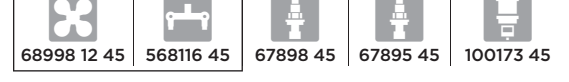

Ref.: 68170 12 45 66
 Llave de paso 1/2\"/>

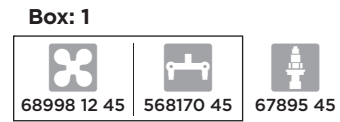

serie Accesorios | Accessories

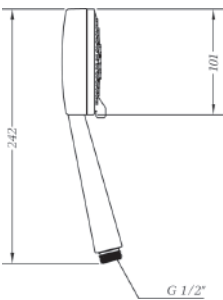

Ref.: DXK3 45
 Mango de ducha K3 jets
 K3 jets handshower

Box: 1 | Carton: 36 | Pallet: 324

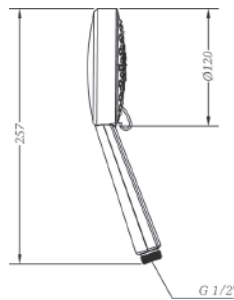

Ref.: DXT5 45
 Mango de ducha T5 jets
 T5 jets handshower

Box: 1 | Carton: 24 | Pallet: 288

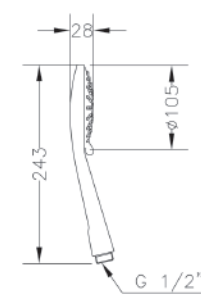

Ref.: DXT3 45
 Mango de ducha T3 jets
 T3 jets handshower

Box: 1 | Carton: 36 | Pallet: 324

Accesorios | Accessories

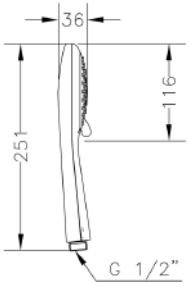

Ref.: DXO3 45
Mango de ducha O3 jets
O3 jets handshower

Box: 1 | Carton: 36 | Pallet: 324

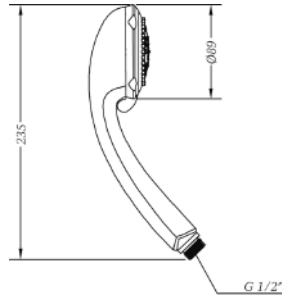

Ref.: DXE5 45
Mango de ducha E5 jets
E5 jets handshower

Box: 1 | Carton: 45 | Pallet: 405

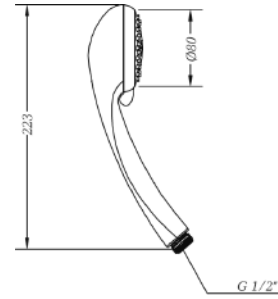

Ref.: DXE2 45
Mango de ducha E2 jets
E2 jets handshower

Box: 1 | Carton: 45 | Pallet: 540

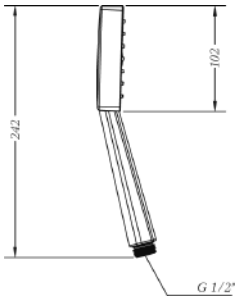

Ref.: DXK1 45
Mango de ducha K1 jets
K1 jet handshower

Box: 1 | Carton: 36 | Pallet: 324

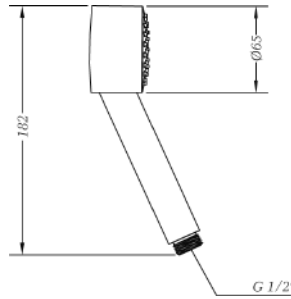

Ref.: 100197 45 00
Mango de ducha C1 jet
C1 jet handshower

Box: 1 | Carton: 100 | Pallet: 1800

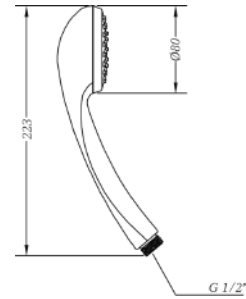

Ref.: 100175 45 00
Mango de ducha E1 jet
E1 jet handshower

Box: 1 | Carton: 60 | Pallet: 1080

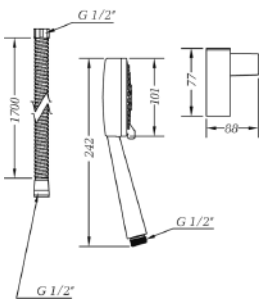

Ref.: 100698 45
Kit de ducha Kenjo, flexo, soporte y ducha 3 jets
Kenjo shower set, flexible hose, holder and 3 jets
handshower

Box: 1 | Carton: 18 | Pallet: 216

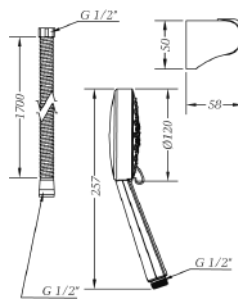

Ref.: 100699 45
Kit de ducha Tau, flexo, soporte y ducha 5 jets
Tau shower set, flexible hose, holder and 5 jets
handshower

Box: 1 | Carton: 18 | Pallet: 216

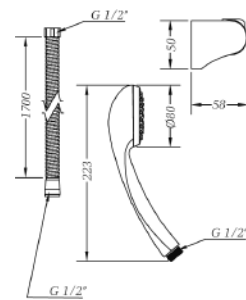

Ref.: 100697 45
Kit de ducha GE2, flexo, soporte y ducha 1 jet
GE2 shower set, flexible hose, holder and 1 jet
handshower

Box: 1 | Carton: 18 | Pallet: 216

Accesorios | Accessories



Ref.: 1748 45
 Conjunto Tau, barra, flexo y ducha 5 jets
 Tau set, bar, hose and 5 jets handshower

Box: 1 | Carton: 10 | Pallet: 60

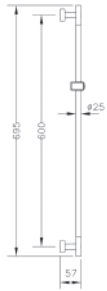

Ref.: 1637 45
 Barra ducha Kenjo
 Kenjo shower bar

Box: 1 | Carton: 10 | Pallet: 60

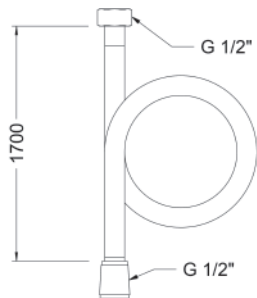

Ref.: 100135 60 00
 Flexo H 1/2" - H 1/2" 1,70 m inoxidable
 F 1/2" - F 1/2" Stainless steel flexible hose 1.70 m

Box: 1 | Carton: 50 | Pallet: 900

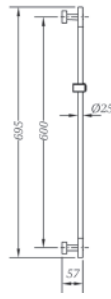

Ref.: 1747 45
 Conjunto Kenjo, barra, flexo y ducha 3 jets
 Kenjo set, bar, flexible hose and 3 jets handshower

Box: 1 | Carton: 10 | Pallet: 60

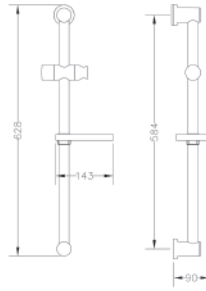

Ref.: 1638 45
 Barra ducha redonda
 Round shower bar

Box: 1 | Carton: 10 | Pallet: 100

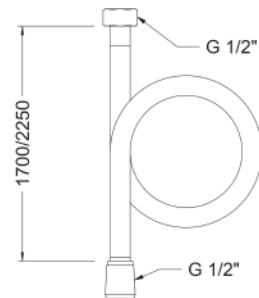

Ref.: 100137 60 00
 Flexo extensible H 1/2" - H 1/2" 1,70 - 2,25 m
 inoxidable
 F 1/2" - F 1/2" Extensible stainless steel flexible
 hose 1.70 to 2.25 m

Box: 1 | Carton: 50 | Pallet: 900

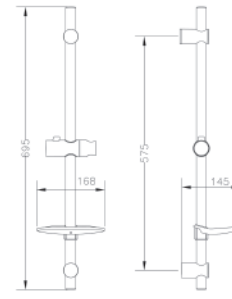

Ref.: 1636 45
 Barra ducha TAU
 TAU shower bar

Box: 1 | Carton: 10 | Pallet: 90

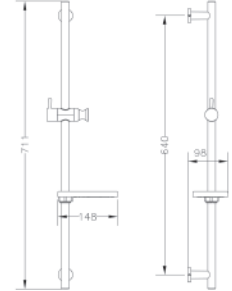

Ref.: 1639 45
 Barra ducha metálica
 Metallic shower bar

Box: 1 | Carton: 8 | Pallet: 48

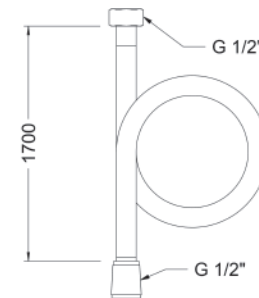

Ref.: 100140 30
 Flexo H 1/2" - H 1/2" 1,70 m. PVC antirrotura
 F 1/2" - F 1/2" PVC flexible hose 1.70 m anti-
 breaking

Box: 1 | Carton: 24 | Pallet: 432

Accesorios | Accessories

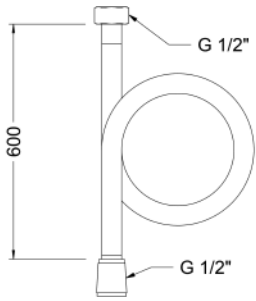

Ref.: 9908 0203
Flexo H1/2" - H1/2" 60cm
F1/2"-F1/2" 60cm Flexible hose

Box: 5 | Carton: 75

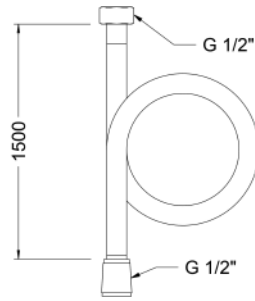

Ref.: 9908 0206
Flexo H 1/2" - H 1/2" 1,5 m cromado
F 1/2" - F 1/2" 1.5 m chromed flexible hose

Box: 2 | Carton: 30

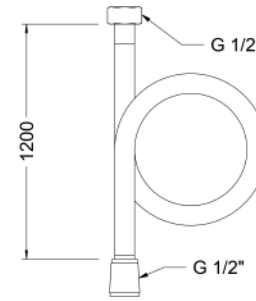

Ref.: 100141 45
Flexo H 1/2" - H 1/2" 1,20 m inoxidable
F 1/2" - F 1/2" Stainless steel flexible hose 1.20 m

Box: 1 | Carton: 50 | Pallet: 900

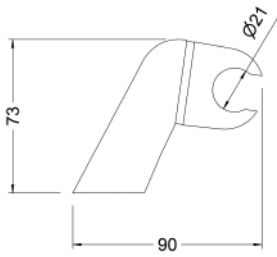

Ref.: 100152 45 00
Soporte ducha Combi
Combi shower holder

Box: 1 | Carton: 150 | Pallet: 2700

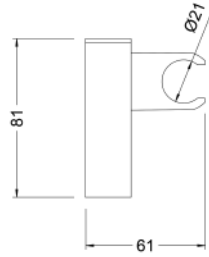

Ref.: 100149 45
Soporte ducha Kenjo
Kenjo shower holder

Box: 1 | Carton: 60 | Pallet: 2520

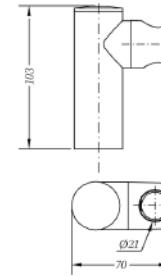

Ref.: 100153 45
Soporte ducha cilíndrico
Cylindrical shower holder

Box: 1 | Carton: 230 | Pallet: 2760

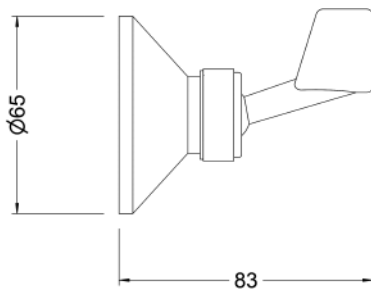

Ref.: 1647 45
Soporte ducha Clásico
Classic shower holder

Box: 1 | Carton: 40 | Pallet: 960

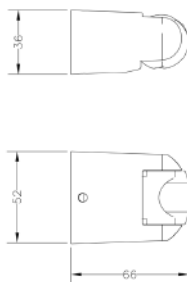

Ref.: 100068 45
Soporte ducha ovalado
Oval shower holder

Box: 1 | Carton: 150 | Pallet: 1800

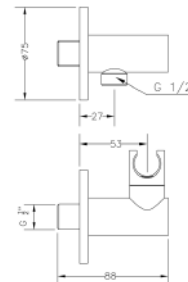

Ref.: 1633 04
Soporte ducha con toma cilíndrico
Round flexible wall conector

Box: 1 | Carton: 75 | Pallet: 1800

Accesorios | Accessories

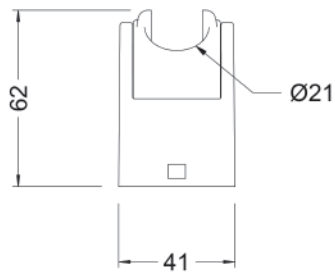

Ref.: 1000 67 45
Soporte ducha GE2
GE2 shower holder

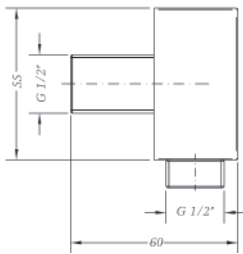

Ref.: 1679 04
Toma ducha mural cuadrada
Square wall flexible connector

Box: 1 | Carton: 96 | Pallet: 2304

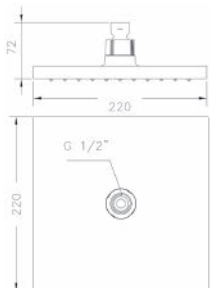

Ref.: R63112 26
Rociador cuadrado 22 cm
Square shower head 22 cm

Box: 1 | Carton: 24 | Pallet: 144

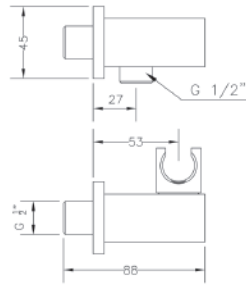

Ref.: 1649 04
Soporte ducha con toma cuadrado
Square flexible wall conector

Box: 1 | Carton: 50 | Pallet: 1600

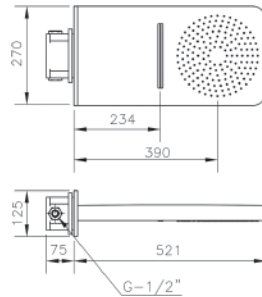

Ref.: 1643 45
Rociador doble función cascada-lluvia
Shower head double function waterfall-rain

Box: 1 | Carton: 2 | Pallet: 12

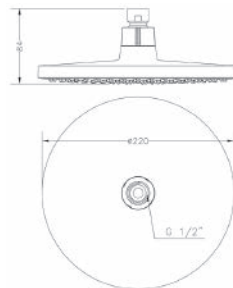

Ref.: R65112 18
Rociador redondo 22 cm
Round shower head 22 cm

Box: 1 | Carton: 24 | Pallet: 144

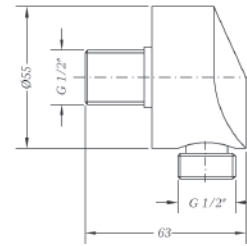

Ref.: 1680 04
Toma ducha mural redonda
Round wall flexible connector

Box: 1 | Carton: 96 | Pallet: 2304

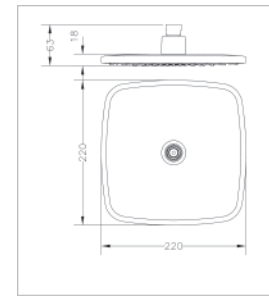

Ref.: R63112 08
Rociador ovalado 22 cm
Oval shower head 22 cm

Box: 1 | Carton: 24 | Pallet: 192

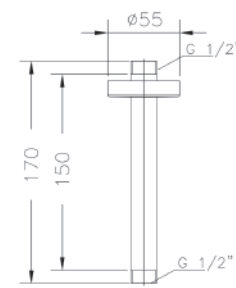

Ref.: 1671 45
Brazo a techo redondo 15 cm
Round roof arm 15 cm

Box: 1 | Carton: 20 | Pallet: 600

Accesorios | Accessories

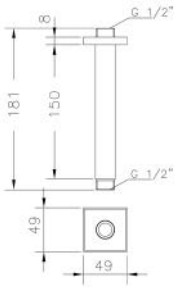

Ref.: 1672 45
Brazo a techo cuadrado 15 cm
Square roof arm 15 cm

Box: 1 | Carton: 20 | Pallet: 800

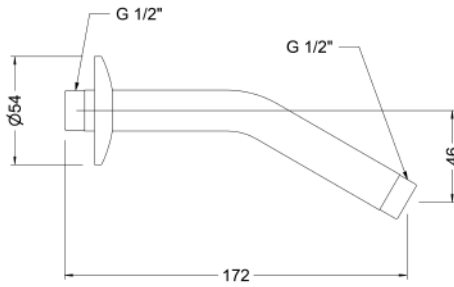

Ref.: 1699 45 00
Brazo pared redondo 12 cm
Round wall arm 12 cm

Box: 5 | Carton: 75 | Pallet: 2700

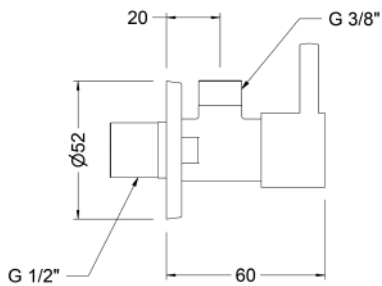

Ref.: 3104 04
Válvula de escuadra redonda 3/8"
Round angle valve 3/8"

Box: 2 | Carton: 120 | Pallet: 4320

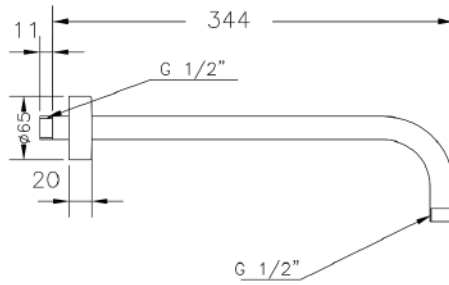

Ref.: B65113 18
Brazo pared redondo 35 cm
Round wall arm 35 cm

Box: 1 | Carton: 20 | Pallet: 600

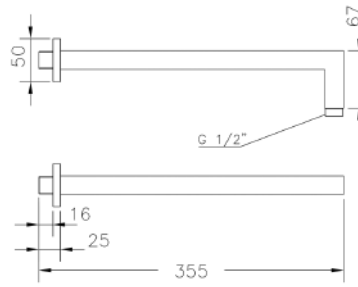

Ref.: B63113 26
Brazo pared cuadrado 35 cm
Square wall arm 35 cm

Box: 1 | Carton: 20 | Pallet: 360

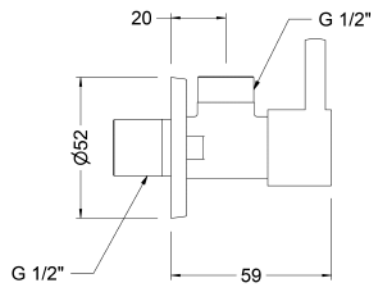

Ref.: 3104 05
Válvula de escuadra redonda 1/2"
Round angle valve 1/2"

Box: 2 | Carton: 120

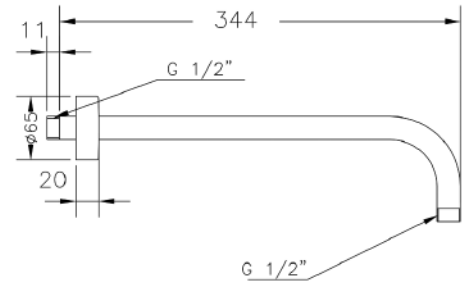

Ref.: B65114 18
Brazo pared redondo 24 cm
Round arm 24 cm

Box: 1 | Carton: 20 | Pallet: 600

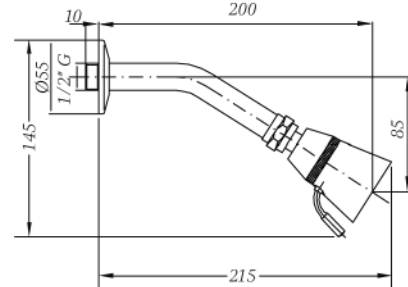

Ref.: 1698 45
Rociador ducha con brazo
Wall shower arm and spray

Box: 1 | Carton: 15 | Pallet: 480

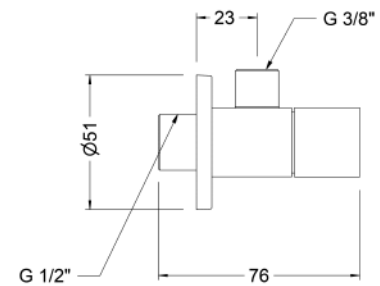

Ref.: 3106 04
Válvula de escuadra cuadrada 3/8"
Square angle valve 3/8"

Box: 2 | Carton: 120 | Pallet: 4320

Accesorios | Accessories

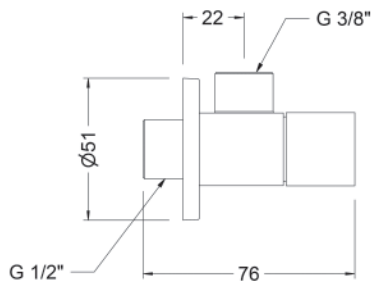

Ref.: 3106 05
Válvula de escuadra cuadrada 1/2"
Square angle valve 1/2"

Box: 2 | Carton: 120 | Pallet: 4320

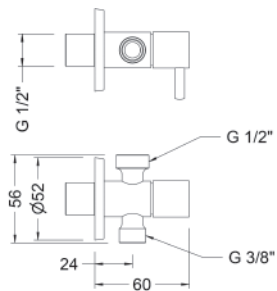

Ref.: 3107 03
Válvula de escuadra doble 1/2" - 3/8" Inox
SS double angle valve 1/2" - 3/8"

Box: 1 | Carton: 160 | Pallet: 3840

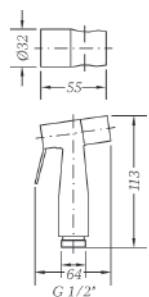

Ref.: 100694 60
Kit ducha sanitaria inox
Inox sanitary shower kit

Box: 1 | Carton: 22 | Pallet: 268

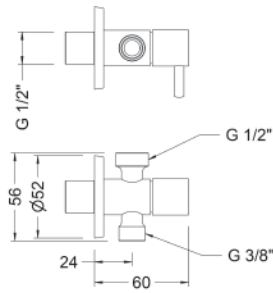

Ref.: 3107 04
Válvula de escuadra doble 1/2" - 3/8" ducha-
inodoro
Double angle valve 1/2" - 3/8"

Box: 1 | Carton: 160 | Pallet: 3840

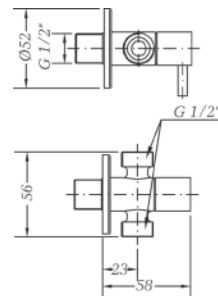

Ref.: 3108 04
Válvula de escuadra doble 1/2" - 1/2" Inox
SS double angle valve 1/2" - 1/2"

Box: 1 | Carton: 160 | Pallet: 3840

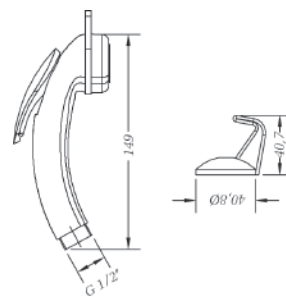

Ref.: 100696 45
Kit ducha sanitaria
Sanitary shower kit

Box: 1 | Carton: 100 | Pallet: 1800

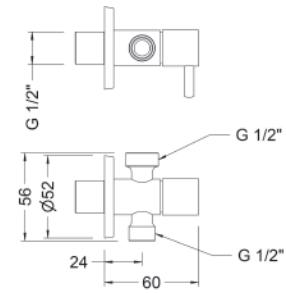

Ref.: 3107 04
Válvula de escuadra doble 1/2" - 1/2" ducha-
inodoro
Double angle valve 1/2" - 1/2"

Box: 1 | Carton: 160 | Pallet: 3840



Ref.: 100694 45
Kit ducha sanitaria
Sanitary shower kit

Box: 1 | Carton: 22 | Pallet: 268

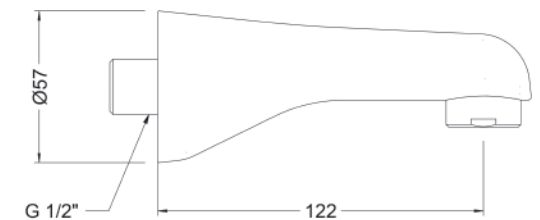

Ref.: 1667 45
Caño mural baño fundido
Casted wall bath spout

Box: 1 | Carton: 60 | Pallet: 1080

Accesorios | Accessories

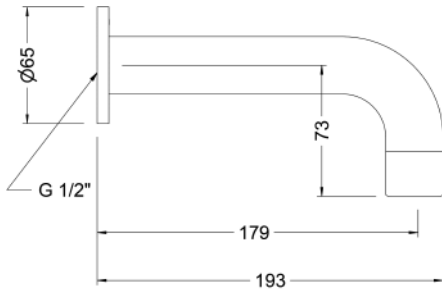

Ref.: 1668 45
Caño mural baño cilíndrico
Round wall bath spout

Box: 1 | Carton: 20 | Pallet: 240

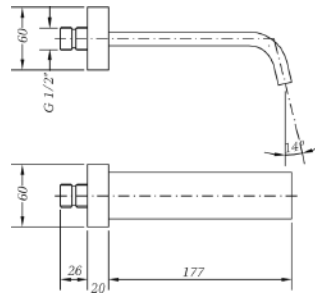

Ref.: 1674 45
Caño mural baño cuadrado
Square wall bath spout

Box: 1 | Carton: 24 | Pallet: 720

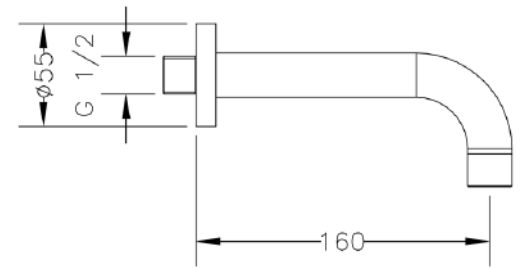

Ref.: 68911 45
Caño mural tubo recto 16 cm
Wall mounted pipe spout 16 cm

Box: 1 | Carton: 40 | Pallet: 640

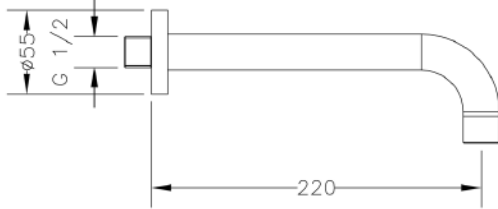

Ref.: 68912 45
Caño mural tubo recto 22 cm
Wall mounted pipe spout 22 cm

Box: 1 | Carton: 40 | Pallet: 640

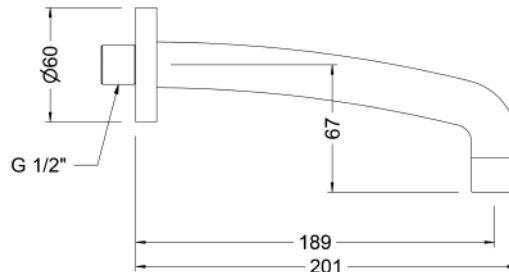

Ref.: 68913 45
Caño mural tubo inclinado 20 cm
Wall mounted sloping pipe spout 20 cm

Box: 1 | Carton: 40 | Pallet: 640

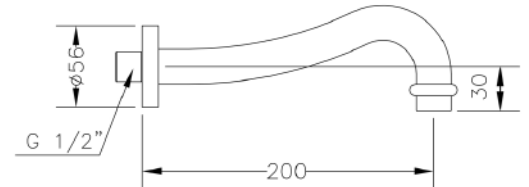

Ref.: 68914 45
Caño mural tubo retro 20 cm
Wall mounted retro pipe spout 20 cm

Box: 1 | Carton: 40 | Pallet: 640

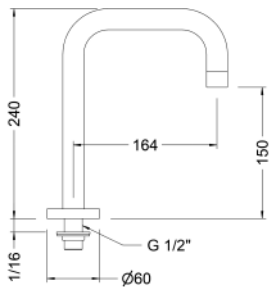

Ref.: 68915 45
Caño encimera recto tubo
Straight pipe spout

Box: 1 | Carton: 30 | Pallet: 480

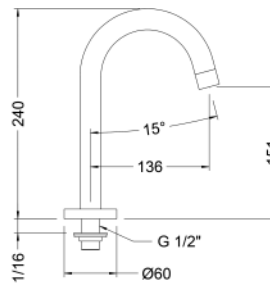

Ref.: 68916 45
Caño encimera cisne tubo
Swan neck pipe spout

Box: 1 | Carton: 30 | Pallet: 480

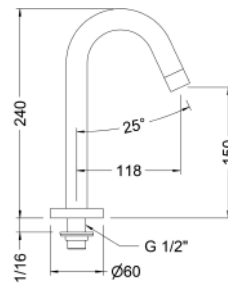

Ref.: 68917 45
Caño encimera inclinado tubo
Sloping pipe spout

Box: 1 | Carton: 30 | Pallet: 480

Accesorios | Accessories

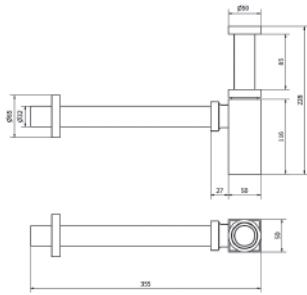

Ref.: 1621 07
Sifon botella para lavabo y bidé 1 1/4"
1 1/4" bidet and wash-basin siphon

Box: 1 | Carton: 12 | Pallet: 216

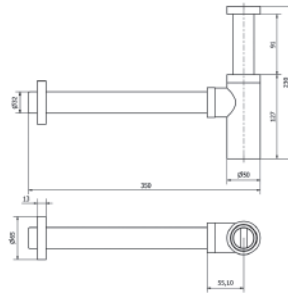

Ref.: 1622 07
Sifon botella para lavabo y bidé 1 1/4"
1 1/4" bidet and wash-basin siphon

Box: 1 | Carton: 12 | Pallet: 216

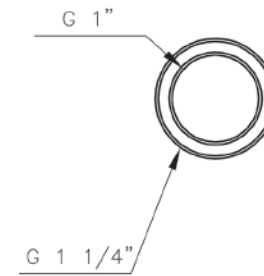

Ref.: 9908 0046
Adaptador sifon 1 1/4" - 1"
Siphon adaptor 1 1/4" - 1"

Box: 100 | Carton: 400

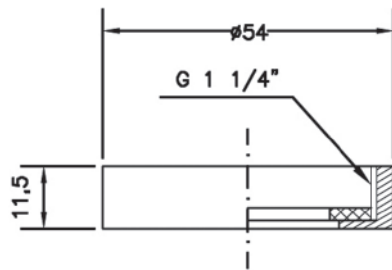

Ref.: 100134 07
Tuerca para sifon 1 1/4"
1 1/4" siphon nut

Box: 30 | Carton: 240

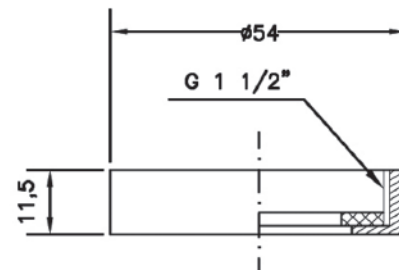

Ref.: 100134 08
Tuerca para sifon 1 1/2"
1 1/2" siphon nut

Box: 30 | Carton: 240 | Pallet: 8640

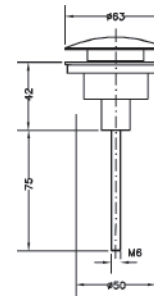

Ref.: 100202 45
Tapa universal "Click remove"
"Click remove" universal cover

Box: 1 | Carton: 60 | Pallet: 1080

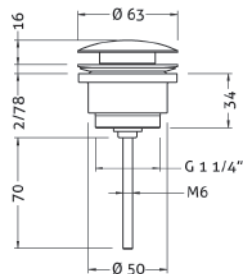

Ref.: 100211 45
Válvula click "Luxe" 1 1/4"
1 1/4" "Luxe" click valve

Box: 1 | Carton: 60 | Pallet: 1080

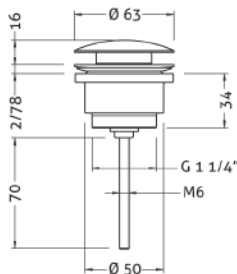

Ref.: 100211 43
Válvula click "Luxe" bronce 1 1/4"
1 1/4" "Luxe" click valve bronze

Box: 1 | Carton: 60 | Pallet: 1080

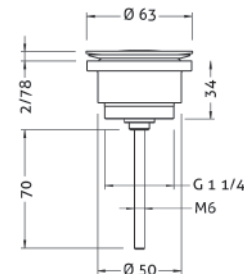

Ref.: 100205 45
Válvula click universal 1 1/4"
1 1/4" universal click valve

Box: 1 | Carton: 60 | Pallet: 1080

Accesorios | Accessories

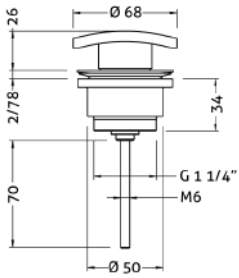

Ref.: 100204 45
Válvula click Kenjo 1 1/4"
1 1/4" Kenjo click valve

Box: 1 | Carton: 60 | Pallet: 1080

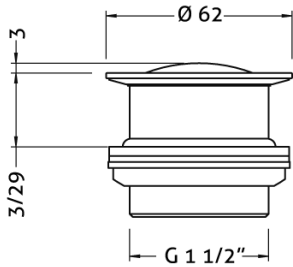

Ref.: 100208 45
Válvula click 1 1/4" bañera
1 1/4" bath click valve

Box: 1 | Carton: 80 | Pallet: 1440

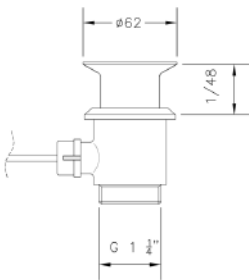

Ref.: 100200 45
Válvula automática plástico 1 1/4"
1 1/4" plastic automatic valve

Box: 1 | Carton: 100 | Pallet: 1200

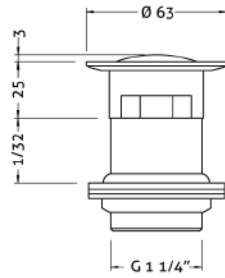

Ref.: 100206 45
Válvula click 1 1/4" con rebodadero
1 1/4" click valve with overflow

Box: 1 | Carton: 60 | Pallet: 1080

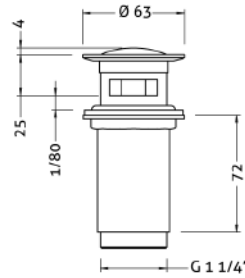

Ref.: 100209 45
Válvula click 1 1/4" con/sin rebosadero
1 1/4" click valve with/out overflow

Box: 1 | Carton: 60 | Pallet: 1080

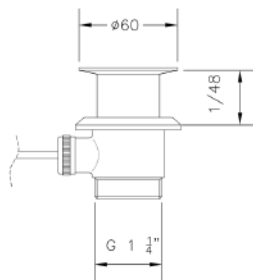

Ref.: 100203 45
Válvula automática metálica 1 1/4"
1 1/4" metallic automatic valve

Box: 1

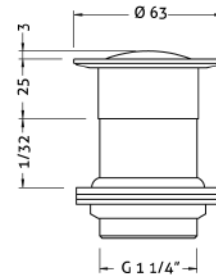

Ref.: 100207 45
Válvula click 1 1/4"
1 1/4" click valve

Box: 1 | Carton: 60 | Pallet: 1080

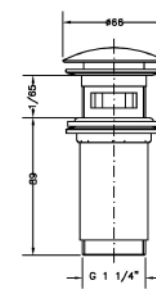

Ref.: 100210 45
Válvula click 1 1/4" con/sin rebosadero
1 1/4" click valve with/out overflow

Box: 1 | Carton: 60 | Pallet: 1080

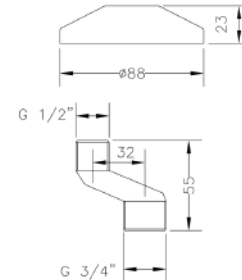

Ref.: 100122 45
Conjunto florón y excéntricas gigantes
Giant escutcheon eccentric set

Box: 1 | Carton: 72 | Pallet: 1728

Accesorios | Accessories

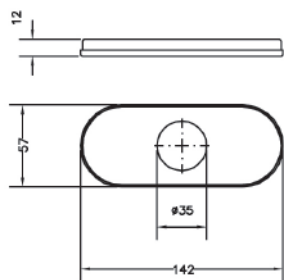

Ref.: P130
Placa adaptadora 4"
4" adaptor plate

Box: 5 | Carton: 240 | Pallet: 4320

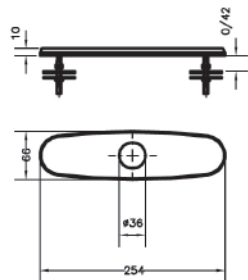

Ref.: P200
Placa adaptadora 8"
8" adaptor plate

Box: 5 | Carton: 100 | Pallet: 3600

Índice por referencia | Index by reference

Ref.:	Serie	Technic	Ref.:	Serie	Technic	Ref.:	Serie	Technic
100068 45	165	239	1008 04	102	216	568083 45	128	229
100122 45	174	245	1009 04	101	216	568104 45	128	229
100134 07	171	244	1023 04	103	216	568193 45	127	229
100134 08	171	244	1024 04	101	216	568195 45	127	229
100135 43 00	107		1155 04	167		568550 45	118	223
100135 60 00	164	238	1621 07	171	244	568555 45	118	223
100137 60 00	164	238	1622 07	171	244	568565 45	118	223
100140 30	164	238	1633 04	165	239	568575 45	118	224
100141 45	164	239	1636 45	162	238	60001 22 45 67	101	216
100149 45	165	239	1637 45	163	238	60100 22 45 66	99	215
100152 45 00	165	239	1638 45	163	238	60100 28 45 66	91	212
100153 45	165	239	1639 45	163	238	60110 22 45 66	99	215
100175 45 00	161	237	1643 45	166	240	60110 28 45 66	91	212
100196 43 00	107		1647 43	107		60130 22 45 66	98	215
100196 45 00	106		1647 45	106	239	60130 28 45 66	88	212
100197 45 00	161	237	1649 04	165	240	60134 28 45 66	88	212
1002 04	101	216	1667 45	169	242	60140 22 45 66	98	215
100200 45	173	245	1668 45	169	243	60140 28 45 66	89	212
100202 45	172	244	1671 45	167	240	60188 22 45 66	98	215
100203 45	173	245	1672 45	166	241	60188 28 45 66	88	212
100204 45	172	245	1674 45	169	243	60194 05 45 66	102	216
100205 45	172	244	1679 04	166	240	60198 05 45 66	102	217
100206 45	172	245	1680 04	166	240	60199 05 45 66	102	217
100207 45	173	245	1698 45	167	241	61115 22 45 66	99	215
100208 45	173	245	1699 45 00	167	241	61115 28 45 66	91	212
100209 45	173	245	1744 45	22	193	61116 22 45 66	100	215
100210 45	173	245	1745 45	154	202	61116 28 45 66	91	213
100211 43	172	244	1746 45	152	210	61130 22 45 66	98	215
100211 45	172	244	1747 45	162	238	61130 28 45 66	88	212
1003 04	101	216	1748 45	162	238	61142 22 45 66	98	215
1005 04	102	216	3104 04	168	241	61142 28 45 66	89	212
1006 04	103	217	3104 05	168	241	61190 28 45 66	94	214
100694 45	169	242	3106 04	168	241	61192 28 45 66	94	214
100694 60	169	242	3106 05	168	242	61195 28 45 66	94	214
100696 45	169	242	3107 03	168	242	61196 28 45 66	94	214
100697 45	161	237	3107 04	168	242	61200 28 45 66	94	214
100698 45	161	237	3108 03	168	242	61201 28 45 66	93	213
100699 45	161	237	3108 04	168	242	61203 28 45 66	93	213
1007 04	103	217	3109 04	168		61204 28 45 66	93	213

Ref.:	Serie	Technic	Ref.:	Serie	Technic	Ref.:	Serie	Technic
61205 28 45 66	93	214	64115 16 45 66	154	198	65116 18 45 66	50	200
61206 28 45 66	93	213	64116 14 45 66	156	197	65116 19 45 66	21	192
61210 28 45 66	93	213	64116 16 45 66	29	195	65116 29 45 66	70	207
61900 28 45 66	94	214	64117 04 45 66	43	198	65117 18 45 66	50	201
62100 08 45 67	13	190	64118 04 45 66	152	199	65118 18 45 66	150	201
62110 31 45 67	13	190	64130 04 45 66	42	198	65130 19 45 66	18	191
62114 30 45 66	15	191	64130 14 45 66	34	196	65131 18 45 66	48	199
62115 31 45 66	15	190	64130 16 45 66	26	194	65131 19 45 66	18	191
62117 31 45 66	156	191	64131 14 45 66	34	196	65131 29 45 66	68	206
62118 31 45 66	15	191	64131 16 45 66	26	194	65132 18 45 66	48	199
62130 08 45 66	12	190	64132 14 45 66	34	196	65132 19 45 66	18	191
62131 31 45 66	12	190	64132 16 45 66	26	194	65132 29 45 66	68	206
62132 31 45 66	12	190	64134 04 45 66	42	198	65134 18 45 66	48	199
62136 08 45 66	12	190	64134 14 45 66	34	196	65134 19 45 66	18	191
62140 08 45 66	13	190	64134 16 45 66	26	194	65134 29 45 66	68	206
62142 31 45 66	13	190	64136 04 45 66	42	198	65135 18 45 66	48	199
63100 26 45 67	152	209	64136 14 45 66	34	196	65135 29 45 66	68	206
63110 26 45 67	77	209	64136 16 45 66	26	194	65136 18 45 66	48	199
63114 30 45 66	154	236	64140 04 45 66	42	198	65136 19 45 66	18	191
63115 26 45 66	77	209	64140 14 45 66	35	196	65136 29 45 66	68	206
63116 26 45 66	156	209	64140 16 45 66	27	194	65138 18 45 66	48	199
63130 26 45 66	74	208	64142 14 45 66	35	197	65140 19 45 66	20	191
63131 26 45 66	76	208	64142 16 45 66	42	194	65142 18 45 66	49	200
63132 26 45 66	76	208	64192 16 45 66	30	195	65142 19 45 66	20	192
63134 26 45 66	74	208	64201 04 45 66	44	199	65142 29 45 66	69	207
63136 26 45 66	74	208	64201 14 45 66	36	197	65145 18 45 66	49	200
63137 26 45 66	74	208	64201 16 45 66	30	195	65145 29 45 66	69	206
63138 26 45 66	74	208	64206 14 45 66	36	197	65192 18 45 66	59	206
63140 26 45 66	76	208	64206 16 45 66	30	196	65192 19 45 66	21	192
63142 26 45 66	76	208	65100 18 45 66	49	200	65203 18 45 66	57	204
64100 04 45 66	43	198	65100 19 45 66	20	192	65203 18 60 66	84	211
64100 14 45 66	35	197	65100 29 45 66	69	207	65203 19 45 66	21	192
64100 16 45 66	27	194	65110 18 45 66	49	200	65204 18 45 66	55	203
64110 04 45 66	43	198	65110 19 45 66	20	192	65205 18 45 66	65	205
64110 14 45 66	35	197	65110 29 45 66	69	207	65206 18 45 66	65	205
64110 16 45 66	27	194	65114 30 45 66	150	201	65207 18 60 66	84	211
64111 14 45 67	51	202	65115 18 45 66	150	200	65208 18 60 66	84	211
64114 14 45 67	51	201	65115 19 45 66	21	192	65211 18 45 66	55	202
64115 14 45 66	36	197	65115 29 45 66	70	207	65211 18 60 66	84	211

Ref.:	Serie	Technic	Ref.:	Serie	Technic	Ref.:	Serie	Technic
65212 18 45 66	55	203	68120 11 45 66	122	225	68200 11 45 66	125	226
65214 18 45 66	55	203	68120 12 45 66	144	235	68201 39 43 66	108	219
65215 40 60 66	84	211	68122 11 45 66	122	225	68201 39 45 66	108	219
65219 18 45 66	59	204	68124 07 45 66	132	231	68500 09 45 66	112	220
65219 40 60 66	84	211	68124 08 45 66	138	233	68505 09 45 66	112	220
65403 18 45 66	59	203	68124 12 45 66	144	235	68506 09 43 66	107	218
65404 18 45 66	57	203	68125 07 45 66	132	231	68506 09 45 66	106	217
65700 18 45 66	63	204	68125 08 45 66	138	233	68510 09 45 66	112	220
65702 18 45 66	63	204	68125 12 45 66	144	235	68511 09 45 66	112	220
65900 18 45 66	59	205	68130 11 45 66	122	225	68515 09 45 66	114	220
67100 26 45 67	78	209	68131 07 45 66	132	231	68516 09 43 66	107	218
67102 14 45 67	51	201	68131 08 45 66	138	233	68516 09 45 66	106	217
67103 14 45 67	29	195	68131 09 45 66	115	221	68520 09 45 66	114	220
67104 14 45 67	28	195	68131 11 45 66	124	226	68525 09 45 66	114	220
67110 26 45 67	152	209	68131 12 45 66	144	235	68526 09 43 66	107	218
67112 14 45 67	51	201	68132 07 45 66	132	231	68526 09 45 66	106	218
68001 09 45 66	115	221	68132 08 45 66	138	233	68527 09 45 66	115	221
68001 11 45 66	124	226	68132 12 45 66	144	235	68530 09 45 66	114	221
68003 11 45 66	126	228	68140 11 45 66	123	225	68531 09 43 66	107	219
68083 11 45 66	126	228	68142 07 45 66	134	232	68531 09 45 66	106	218
68093 11 45 66	126	228	68142 08 45 66	140	234	68535 09 45 66	115	221
68100 11 45 66	123	226	68142 09 45 66	114	220	68540 09 45 66	116	221
68103 11 45 66	126	228	68142 11 45 66	123	225	68545 09 45 66	117	223
68104 11 45 66	126	228	68142 12 45 66	147	236	68550 09 45 66	116	221
68110 11 45 66	123	226	68160 11 45 66	123	225	68555 09 45 66	116	222
68113 07 45 66	133	232	68170 07 45 66	134	232	68560 09 45 66	116	222
68113 08 45 66	139	234	68170 08 45 66	140	234	68565 09 45 66	116	222
68113 12 45 66	147	236	68170 11 45 66	124	226	68570 09 45 66	117	222
68115 07 45 66	133	232	68170 12 45 66	147	236	68575 09 45 66	117	223
68115 08 45 66	154	234	68180 11 45 66	122	225	68580 09 45 66	117	223
68115 11 45 66	124	226	68190 11 45 66	125	227	68585 09 45 66	117	223
68115 12 45 66	145	236	68193 11 45 66	125	227	68590 09 45 66	115	221
68116 07 45 66	133	232	68194 09 45 66	117	223	68595 09 43 66	108	219
68116 08 45 66	139	234	68194 11 45 66	127	229	68595 09 45 66	108	219
68116 11 45 66	124	226	68195 11 45 66	125	227	68901 45	128	229
68116 12 45 66	154	236	68196 09 45 66	116	222	68902 45	128	229
68120 07 45 66	132	231	68196 11 45 66	125	227	68903 45	128	230
68120 08 45 66	138	233	68197 11 45 66	125	227	68904 45	128	230
68120 09 45 66	112	220	68199 11 45 66	127	229	68908 45	128	230

Ref.:	Serie	Technic	Ref.:	Serie	Technic	Ref.:	Serie	Technic
68909 45	128	230	CM65110 18	52	202	FRK63401	78	210
68910 45	128	230	CM65110 19	22	193	FRT65401	59	204
68911 45	170	243	CM65110 29	70	207	FRT65402	57	204
68912 45	170	243	CT67110 18	52	202	FRV61205	65	205
68913 45	170	243	CT67110 19	22	193	FRV61206	65	205
68914 45	170	243	CT67110 26	80	210	FT00	63	204
68915 45	170	243	DXE2 45	160	237	FT92	63	204
68916 45	170	243	DXE5 45	160	237	P130	174	246
68917 45	171	243	DXK1 45	161	237	P200	174	246
9908 0046	171	244	DXK3 45	160	236	R63112 08	166	240
B63113 26	167	241	DXO3 45	160	237	R63112 26	167	240
B65113 18	167	241	DXT3 45	160	236	R63112 08	167	
B65114 18	167	241	DXT5 45	160	236	R65112 18	167	240
CM63110 26	80	210	FRK63400	78	210			

CONDICIONES GENERALES DE VENTA

PRECIOS: Los precios se entienden en nuestro almacén, siendo los portes, el I.V.A. y acarreo a cargo del comprador, salvo acuerdo previo en contra.

CONDICIONES DE PAGO: En aplicación de la Ley 15/2010 que limita los plazos máximos de pago en las operaciones comerciales, hemos ajustado las condiciones a lo dispuesto en la misma. En caso de diferirse el pago, los gastos de negociación de efectos y/o los intereses legales especificados serán a cargo del comprador. El impago de cualquier efecto o recibo, conllevará la inmediata suspensión de suministros y servicios.

PEDIDOS: Para la tramitación de cualquier suministro será indispensable que el comprador nos remita el pedido por escrito indicando claramente la referencia GENE BRE, incluidos los dígitos de la medida y también la cantidad deseada en base a las unidades de compra mínima (por caja), tal como especifica GENE BRE en su catálogo. Si existen condicionantes no previstos, GENE BRE S.A. se reserva el derecho de aceptación o anulación de los pedidos cursados. Cada pedido solicitado a GENE BRE S.A. genera una expedición para el cliente con su coste de transporte correspondiente; por lo que recomendamos preparen sus pedidos completos una vez al día para optimizar el transporte. Todos los pedidos serán confirmados por GENE BRE, S.A. vía email/fax. Salvo notificación de lo contrario en las siguientes 24 horas, el pedido confirmado seguirá su curso sin derecho a posteriores reclamaciones.

TARIFAS DE PRECIOS: GENE BRE S.A. comunicará a sus clientes cualquier cambio que se produzca en las tarifas del catálogo a través de alguna de las vías de comunicación usuales (web, email, correo).

CANCELACIÓN DE PRODUCTOS DE CATALOGO: GENE BRE, S.A. comunicará a sus clientes cualquier cancelación de productos del catálogo.

ESPECIFICACIONES TÉCNICAS: El catálogo de GENE BRE, S.A. contiene los requisitos técnicos y normas aplicables a los productos suministrados. GENE BRE S.A. se reserva la facultad de cambiar en todo o en parte el diseño y materiales de cualquiera de sus productos, debido a la mejora continua de nuestros productos.

EXPEDICIONES: Todo pedido superior a 500 euros en Península se suministran a portes pagados. Para Canarias, Ceuta, Melilla y Andorra, el pedido mínimo será de 1.000 euros. Las mercancías viajan siempre por cuenta y riesgo del comprador, aún en los casos de convenios especiales.

ENTREGA: Los pedidos se suministrarán siempre por cajas completas, según especificaciones de catálogo.

RECLAMACIONES: Las eventuales reclamaciones deberán formularse dentro de los 15 días siguientes al de recepción de la mercancía por el comprador, rechazándose las efectuadas después de dicho plazo límite. NO se aceptará ninguna devolución de material sin aprobación previa de nuestro Departamento Comercial que facilitará un número de boletín de devolución que debe acompañar al material devuelto. Todas las devoluciones serán con los portes a cargo del comprador. Y se realizará un cargo por demérito del 10% del valor de la mercancía para todos los materiales, excepto para las válvulas automatizadas que será del 30%.

GARANTIA: Queda limitada al reemplazo de las piezas reconocidas como defectuosas de fabricación por el Departamento de Calidad de GENE BRE S.A.. No admitiremos ninguna reclamación transcurridos 15 días de la recepción de la mercancía por el comprador.

PROPIEDAD DE LA MERCANCÍA: GENE BRE, S.A. se reserva el derecho de propiedad de la mercancía suministrada, hasta que el comprador no haya satisfecho totalmente el importe de la misma. En el intervalo, se considerará en concepto de depósito y custodia. La mercancía podrá ser retirada por incumplimiento de pago en el plazo previamente estipulado.

LITIGIOS: En caso de litigio, ambas partes aceptan someter sus diferencias a los Juzgados de L'Hospitalet de Llobregat.

GENERAL SALES CONDITIONS

PRICES: Prices are considered to be EX WORKS, being the freight and transportation at the cost of the purchaser, unless previous agreement has been reached.

PAYMENT TERMS: We have adjusted the conditions in application of Law 15/2010 which limits the maximum terms of payment in commercial transactions. The maximum delay on payment will be of 60 days after invoice date. Payment term will be as accorded between the parties. In case of unpaid, the expenses and interest occurred will be paid by the purchaser. The unpaid maturity will imply the complete suspension of any service or supply.

ORDERS: Regarding the handling of any supply, it is compulsory for the purchaser to send a written signed and sealed purchasing order indicating clearly GENE BRE's reference, including measures digits, and also the quantity required according to obligated minimum units of purchase (boxes), as GENE BRE's Catalogue specifies. In case of unexpected discrepancies, GENE BRE has the right to accept or cancel the pending orders. Each order required to GENE BRE, S.A., opens a client expedition with corresponding transports cost, because of that, we recommend to prepare complete orders once a day to improve the transport. All the orders will be confirmed by GENE BRE by e-mail/fax. Each confirmed order will be handled without any right from the purchaser to modify it, unless previous notification before 24 hours after confirmation.

PRICE LIST: GENE BRE will inform the customers about any change in the price list, using some usual communication way (web, e-mail or post).

PRODUCTS WITHDRAWAL FROM CATALOGUE: GENE BRE S.A. will inform the customers about any product withdrawal from the catalogue.

TECHNICAL SPECIFICATIONS: GENE BRE's catalogue holds all the technical requirements and applicable norms about the products.

SHIPMENT: Goods are shipped under the purchaser's own risk, even in special cases.

DELIVERY: Orders will always be shipped according to full boxes, as specified in the catalogue.

CLAIMS: Eventual claims must be done within 15 days after date of reception of the goods by the purchaser. Claims after such period will not be considered. NO devolution will be accepted without the previous approval from our Sales Department, who will issue a devolution certificate that must be enclosed in the devolution goods. All devolutions' freight will be paid by the purchaser. Additionally, an unworthiness debit of 10% of the products' value will be charged, except for the automatic valves that are a 30%.

GUARANTEE: It is limited to defective pieces replacement identified by GENE BRE's Quality Department. We will not accept any return after 15 days from the date of reception by the purchaser.

PROPERTY OF THE GOODS: GENE BRE has the property right of the supplied goods, until the purchaser has totally paid its value. In the meantime, it will be considered as deposit and custody. Goods shall be claimed in case of breach of payment terms.

DISPUTES: In case of disputes, both parties agree to solve discrepancies in the Barcelona Court of Justice.



The logo for Genebre, featuring a stylized 'G' icon followed by the word 'NEBRE' in a bold, sans-serif font.

GENEBRE GROUP Edificio Genebre • Avda. Joan Carles I, 46-48 • 08908 L'Hospitalet de Llobregat (Barcelona) ESPAÑA

www.genebre.es